

United States | January 2020

PRICELIST



THIS PRICE LIST IS INTERACTIVE

Clicking on the Series in the Table of Contents page will take you to the beginning of that Series.

| | |
|-----------------------------|-----|
| INTRODUCTION | |
| Terms & Conditions..... | 3 |
| Shipping Program..... | 4 |
| Cleaning & Maintenance..... | 5 |
| SEATING | |
| Bean..... | 7 |
| Bud..... | 9 |
| Calvin..... | 11 |
| Companion..... | 22 |
| Cooper Collection | |
| Bala..... | 34 |
| Dwight..... | 50 |
| Huntsville..... | 65 |
| Midland..... | 77 |
| Cooper Rocks..... | 88 |
| Crayon..... | 91 |
| Dignity..... | 94 |
| Dignity2..... | 102 |
| Eighteen5 & Twenty2 | |

CALVIN Public Seating
LAYOUTS

Description

- Spec's Calvin offers an oval steel frame with either wood or aluminum side rails.
- Your layout possibilities are unlimited with spacer, radius and corner tables for both standard and bariatric seating. It actually are combination.
- Bariatric seating is 16" wide seat and is load rated to 750 lbs. Cannot be connected to other bariatric seats.
- 21" seat width is standard.
- Choice of wood or polyurethane arms.
- Wood and polyurethane arms are not available in the fabric.
- Two and three seat models offer a choice of no corner arms or full arms between seats.
- Glides and casters/seat and back are standard.
- Please send a drawing of the configuration you require with your order.
- Ships assembled as one, two and three seat units.
- For fabrics you wish upholster or repairs longer than 5' x 5', please contact the factory with repeat information and package requirements will be provided.

LAYOUTS AND DIMENSIONS

Toll Free: 1-888-763-2732



The "Back to Contents" button on the top left of each page will take you back to the Table of Contents page.

CALVIN Public Seating
LAYOUTS

Description

- Spec's Calvin offers an oval steel frame with either wood or aluminum side rails.
- Your layout possibilities are unlimited with spacer, radius

| | |
|-----------------------------|-----|
| INTRODUCTION | |
| Terms & Conditions..... | 3 |
| Shipping Program..... | 4 |
| Cleaning & Maintenance..... | 5 |
| SEATING | |
| Bean..... | 7 |
| Bud..... | 9 |
| Calvin..... | 11 |
| Companion..... | 22 |
| Cooper Collection | |
| Bala..... | 34 |
| Dwight..... | 50 |
| Huntsville..... | 65 |
| Midland..... | 77 |
| Cooper Rocks..... | 88 |
| Crayon..... | 91 |
| Dignity..... | 94 |
| Dignity2..... | 102 |
| Eighteen5 & Twenty2..... | 117 |
| Twenty2..... | 122 |
| TABLES | |
| Acute..... | 306 |
| Annex..... | 315 |
| Ark..... | 317 |
| Boardgames..... | 328 |
| Conductor..... | 346 |
| Cooper Tables..... | 355 |
| Dart..... | 357 |
| Drum, Cube & Oval..... | 362 |
| Drum Bases..... | 364 |
| EndZone..... | 377 |
| Factory..... | 396 |
| Fit..... | 398 |
| Half Round..... | 401 |
| Heavy Duty Tables..... | 410 |
| Manhattan..... | 416 |
| Round Column..... | 428 |
| Rectangle Column..... | 428 |
| Accessories..... | 435 |



TABLE OF CONTENTS

INTRODUCTION

Terms & Conditions 4
 Shipping Program 5
 Cleaning & Maintenance 6

SEATING

Bean 8
 Bud 10
 Calvin 12
 Companion 23
 Cooper Collection
 Bala 35
 Dwight 51
 Huntsville 66
 Midland 78
 Cooper Rocks 89
 Crayon 92
 Dignity 95
 Dignity2 103
 Eighteen5 & Twenty2
 Eighteen5 118
 Twenty2 123
 EndZone Benches 128
 Gravity 134
 Hardi 144
 Heavy Duty Seating
 Calvin HD 150
 Companion HD 151
 Cooper Dwight HD 153
 Dignity 155
 Dignity2 160
 Hardi 172
 Midway HD 176
 Snowball 2 HD 178
 Tailor HD 179
 Traffic Dining 181
 1000 Series HD 182
 2000 Series HD 183
 Jazzy 184
 Midway 191
 Snowball
 Snowball 1 203
 Snowball 2 214
 Snowball 3 225
 Snowflake 237
 Tailor
 Freestanding 242
 Bench 249
 Modular 252
 Booth 266
 Traffic 270
 Urban
 Poly Seat & Plastic Back 276
 Poly Seat & Upholstered Back 283
 Upholstered Seat & Plastic Back 289
 Fully Upholstered 295
 2000 Series 304



TABLES

Acute 317
 Annex 326
 Ark 328
 Askew 339
 Boardgames 343
 Conductor 360
 Cooper Tables 368
 Dani 371
 Docker 376
 Drum, Cube & Oval 381
 Drum Base 383
 EndZone 396
 Factory 415
 Fitt 417
 Half Round 420
 Heavy Duty Tables 429
 Manhattan
 Round Column 437
 Rectangle Column 448
 With Footring 455
 With Media Wall 457
 Midway & Companion Tables 459
 Post Legs 462
 Sidekick 480
 Tailgate 483
 Tailor Tables 496
 Trumpet & Flat Base Tables
 Trumpet 500
 Disc 501
 Square Metal 502
 Rectangle Metal 503
 Tubular 505
 Varsity 513
 Table Accessories
 Modesty Panels 519
 Power Modules 520
 Wire Management & Other 532

OVERBED TABLES & BEDSIDE CABINETS

Bedside Cabinets & Casegoods 535
 Overbed Tables 541

CREDENZAS, CARTS & LECTERNS

Credenzas 544
 Buffet Height Credenzas 547
 Hospitality Carts 549
 Lecterns 550

QUICKSHIP 551

REVISIONS 559

TERMS & CONDITIONS

PRICES

U.S. shipments are FOB Buffalo, New York (refer to Spec's U.S. prepaid shipping program). Prices include all carton and crating charges and do not include any taxes, storage, shipping or installation charges. Prices are subject to change without notice.

WARRANTY

We are pleased to provide the initial purchaser with a Lifetime Structural Warranty against defects in design, construction and materials. Finishes and cover materials are warranted for two years subject to normal wear and tear. Electrical and mechanical parts are warranted for two years. Our warranty will not apply where there is evidence of alteration, misuse, negligence or abuse. No warranty shall apply to COM fabrics. During the warranty period, we will repair, or at our option, replace any product where we are satisfied the product is defective. Decisions on warranty rest solely with Spec™. All freight charges for items being returned for service must be prepaid by the customer. If a claim is accepted, we will gladly refund the charges incurred.

CREDIT

All purchase orders are subject to credit approval. For our established dealers, terms are net 30 days from date of invoice. In some instances a deposit may be required to accompany an order. We will advise you if a deposit is required when we acknowledge your order.

DAMAGE AND CLAIMS

All products are carefully examined before packaging for shipment. Ownership of your product passes to you upon pick-up by the carrier at our factory. Upon receipt of your order, check for any physical damage to the product (even if the carton is unmarked) that may have occurred during transit. Note any physical damage on all copies of the bill of lading and enter a freight claim with the carrier immediately. If you discover damage while unpacking, arrange for a carrier inspection immediately. Any damage, visible or concealed, must be reported to the carrier within 15 days from delivery. Our customer service department would be pleased to help you in any way during the process.

CANCELLATIONS, RETURNS AND CHANGES

Orders are in process once acknowledged and may not be cancelled without our consent. You may be responsible for work in process and administration costs including labor and raw materials. Merchandise may be returned only with our clear written authorization. Freight costs for returns are your responsibility. Our product designs, processes, and materials are always under review ensuring the best quality and value to you. We will do our best to notify you as improvements occur.

ORDERING PROCEDURES

Please submit all orders in writing and fax, e-mail or forward directly to the factory. Orders sent by fax do not require confirmation. Please use our model numbers and finish codes with a brief description of the product(s) being ordered. Your order will be acknowledged promptly and in writing to you (usually by fax or e-mail) once clarified. We request your assistance in checking our acknowledgement's accuracy to your order to ensure discrepancies do not occur. It is your responsibility to let us know of any discrepancies within 5 business days from the acknowledgement date.

CUSTOM ORDERS

Custom orders are encouraged. Our constant design innovation and adaption to new ideas is fueled by our customers. If you can't find what you require, or have a unique application, simply call us.

COM SHIPPING INSTRUCTIONS

All COM fabrics should be ordered and shipped directly to our factory at 165 City View Drive, Toronto, Ontario, Canada, M9W 5B1. For fabric originating in the United States, most suppliers are aware of the required documentation for entry into Canada. Please have your COM supplier mark on the customs documentation that BCB Canada is our customs broker. If there are any questions, please feel free to contact us. All COM fabric shipments should be shipped freight prepaid.

10 DAY QUICKSHIP

The 10 Day Quickship Program is available for a selection of tables and chairs to a maximum quantity of 20 pieces per order. Spec ships your confirmed order within 10 business days – or it's free. Refer to our 10 Day Quickship for more details.



SHIPPING PROGRAM

Shipping costs will be added to your invoice. For orders outside the continental US, contact us for a freight quote.

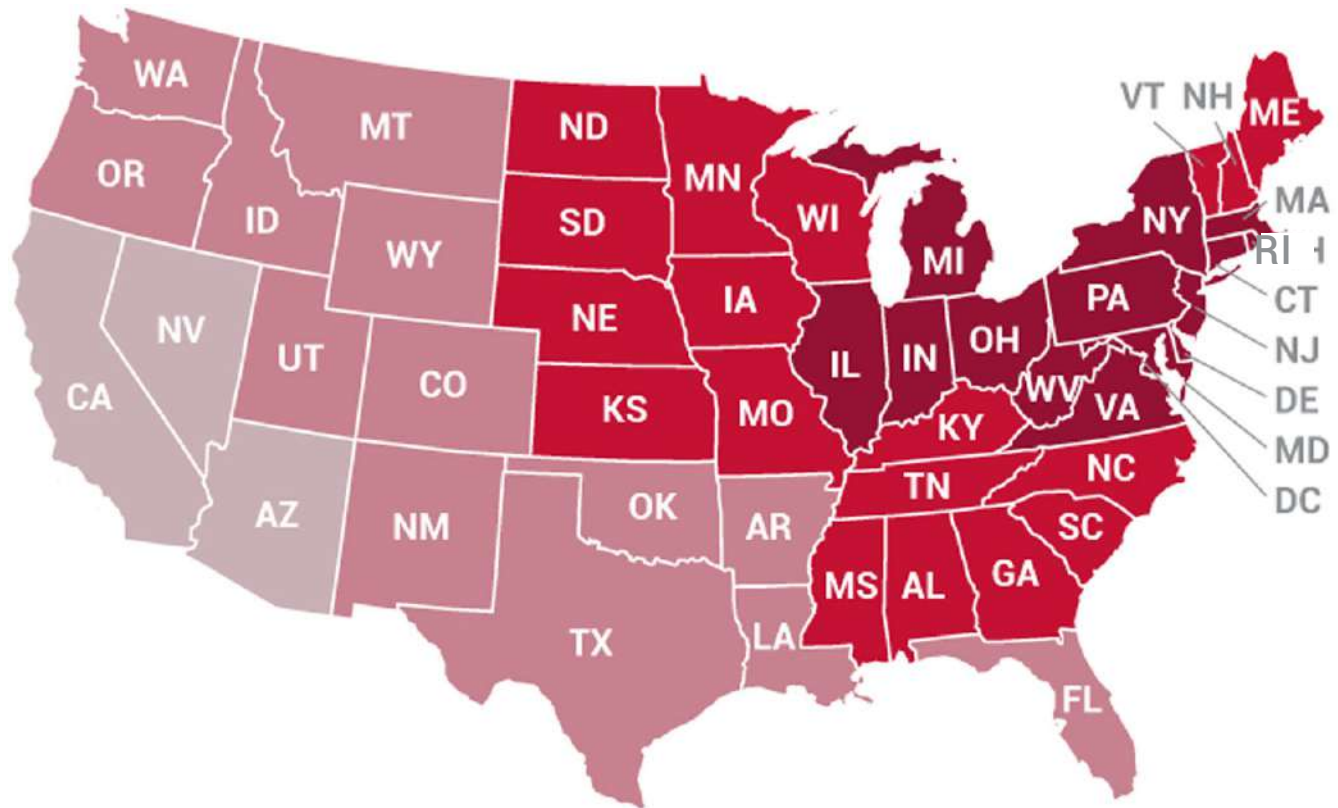

ZONE 5

Orders exceeding \$5,000 List, are shipped at 1% of List.
Orders less than \$5,000 List, are shipped at a flat rate of \$105 Net.

- CONNECTICUT
- DELAWARE
- ILLINOIS
- INDIANA
- MARYLAND
- MASSACHUSETTS
- MICHIGAN
- NEW JERSEY
- NEW YORK
- OHIO
- PENNSYLVANIA
- RHODE ISLAND
- VIRGINIA
- WASHINGTON D.C.
- WEST VIRGINIA

ZONE 6

Orders exceeding \$5,000 List, are shipped at 2% of List.
Orders less than \$5,000 List, are shipped at a flat rate of \$145 Net.

- ALABAMA
- GEORGIA
- IOWA
- KANSAS
- KENTUCKY
- MAINE
- MINNESOTA
- MISSISSIPPI
- MISSOURI
- NEBRASKA
- NEW HAMPSHIRE
- NORTH CAROLINA
- NORTH DAKOTA
- SOUTH CAROLINA
- SOUTH DAKOTA
- TENNESSEE
- VERMONT
- WISCONSIN

ZONE 7

Orders exceeding \$5,000 List, are shipped at 3% of List.
Orders less than \$5,000 List, are shipped at a flat rate of \$145 Net.

- ARKANSAS
- COLORADO
- FLORIDA
- IDAHO
- LOUISIANA
- MONTANA
- NEW MEXICO
- OKLAHOMA
- OREGON
- TEXAS
- UTAH
- WASHINGTON
- WYOMING

ZONE 8

Orders exceeding \$5,000 List, are shipped at 4% of List.
Orders less than \$5,000 List, are shipped at a flat rate of \$145 Net.

- ARIZONA
- CALIFORNIA
- NEVADA

CLEANING & MAINTENANCE

SPECTONE EPOXY FINISH

Light soiling may be removed with a damp cloth or household glass cleaners. Heel marks, heavy soiling and surface marring may be removed with automotive grade polishing compounds or car wax. Do not apply abrasive cleaners, polish or lubricants to table bases or moving parts.

Damaged paint may be repaired with touch-up paint which is available from the factory. Touch-up paint is supplied in powder form to provide an exact match with the existing color. To use the powder, add a small quantity of commercially available lacquer thinner to a small quantity of the powder, stirring with a metal stirrer until the desired consistency is achieved. The paint solution may then be applied using a brush. Avoid using too thick a consistency resulting in brush marks. Allow at least one hour to dry.

LAMINATE TABLE TOPS

Clean with mild soap and water. Do not use abrasive cleaners or wax. Avoid flooding laminate surfaces as water can seep between laminate joints, loosening the finish from the wooden substrate and damaging the substrate.

VENEER TABLE TOPS

Clean with mild soap and water. Always wipe the surface in the direction of the wood grain and ensure there is no pooling of liquid at the seams. Do not use abrasive cleaners or wax.

FOLDING BASES

Remove plastic caps & add 2 drops of WD-40. Move column back and forth to lubricate. Let sit for one hour. Replace plastic caps. To maintain ease of movement, repeat every 6 months.

CHROME

Minor marks may be removed with a household cleaning solvent such as Windex. Chrome polish may be used to restore luster on chrome products.

FABRICS

Care of fabrics varies with the type of fabric. To prevent damage, Spec recommends using only mild water based solutions. For stubborn stains, we recommend that you check the website of the fabric manufacturer or call them for specific cleaning instructions for the fabric. For healthcare applications, stronger cleaning solutions are used for infection control. These solutions must be cleaned off with clean water following their use.

WOOD FRAMES

For light cleaning/dusting, use soft cloth or duster. For stubborn stains, use non-abrasive, water-based cleaners only.

LLDPE - POLYETHYLENE (ROTO-MOLDED MATERIAL)

Minor marks may be cleaned with soap and water. Stains may be removed by applying isopropyl alcohol with a cotton swab.

POLYURETHANE (DURASPEC, ARMS, ARM CAPS)

Clean with mild soap and water. Diluted cleaners and disinfectants may also be used, but wiped dry immediately after application. Do not leave to dry.

POLYPROPYLENE

Clean with mild soap and water. Stains may be removed by applying isopropyl alcohol or hydrogen peroxide in low concentration with a cotton swab. Wipe dry immediately after application. Do not leave to dry.

GLASS-FILLED NYLON ARMS

Clean with mild soap and water.



SEATING

BEAN Children's Series



PRODUCT CODE



FINISHES

LAMINATE



Select from 15 standard laminates or choose any standard Wilsonart, Nevamar, Formica, Arborite and Pionite matte finish laminates at no upcharge

BASE



Select from one of our 76 standard Spectone colors

EDGE



See Spectone Card or specfurniture.com/materials/finishes for a complete list of finish options and colors.

HOW TO ORDER

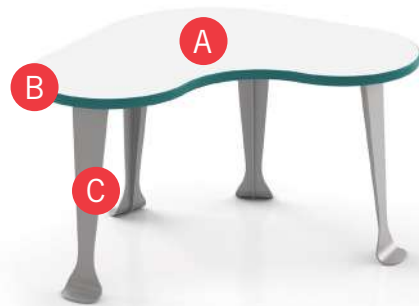

Specify Model

- A** Specify Laminate Surface
Manufacturer, Laminate Name, Laminate Code
- B** Specify Edge Type and Color
PVC Flat
- C** Specify Base Finish

Optional: Custom Solutions

| Model | Laminate Surface | Edge Type and Color | Base Finish |
|-------------|------------------------------------|---------------------|-------------|
| 3030SQ BEAN | Wilsonart, Designer White, D354-60 | PVC Flat, RAL 6000 | Silver |



BEAN Children's Series

Standard Features

- Select from 15 standard laminates or choose any standard Wilsonart, Nevamar, Formica, Arborite and Pionite matte finish laminates at no upcharge
- Edge is PVC Flat (PVF) with 38 colors available to match base finishes
- Frame in any Spectone color
- 1" NU Green earth friendly core
- Ships KD

Options

- Non-standard laminates, contact Spec™ for pricing
- Custom table shapes, contact Spec for pricing



Bean Stool

MODEL **4020** PRICE **240**

Dimensions (inches)
 seat H 12.0 total W 18.0 depth 18.0



4020
14 lbs

Bean Tables

MODEL **30x30 SQ BEAN** PRICE **603**

Square Shape

Dimensions (inches)
 table H 21.0 total W 30.0 depth 30.0



30 x 30 SQ BEAN
38 lbs

MODEL **32x32 BN BEAN** PRICE **603**

Bean Shape

Dimensions (inches)
 table H 21.0 total W 32.0 depth 32.0



32 x 32 BN BEAN
35 lbs



BUD Collaborative Stool



PRODUCT CODE

2501

Series

- 2501 : Round
- 2502 : Square
- 2503 : Crescent

FINISHES

FABRIC



Select fabrics from one of our textile partners

HOW TO ORDER



Specify Model

- A** Specify Fabric - Body
Manufacturer, Pattern Name, Color
- B** Specify Fabric - Top
Manufacturer, Pattern Name, Color

Optional: CAL 133

| Model | Fabric - Body | Fabric - Top |
|-------|-------------------------------------|-------------------------------------|
| 2501 | CF Stinson, Avant AV101, Sun Yellow | CF Stinson, Avant AV101, Sun Yellow |



BUD Collaborative Stool

Standard Features

- Glides
- Ships 1/carton 8 cu ft
- Weight load tested to 250 lbs

Contact Spec Customer Service to railroad fabrics (specify repeat info and yardage requirement will be provided) and for repeats greater than 5" x 5"

Options

- Antibacterial and antimicrobial fabrics available
- CAL 133
- Different fabrics on seat and sides are available. If two fabrics are the same grade, add \$66 List per stool. For different grades of fabric, average the two grades and add \$66 List per stool.
- Custom height may be available, contact Spec

Collaborative Stools - Round

COM 1.3 yd
0.5 yd COM per seat
0.8 yd COM for sides

| MODEL | COM | GR1 | GR2 | GR3 | GR4 | GR5 | GR6 |
|-------------|------------|------------|------------|------------|------------|------------|------------|
| 2501 | 426 | 486 | 504 | 545 | 605 | 651 | 712 |

Dimensions (inches)
seat H 18 DIA 16

CAL 133, add \$158 List per stool



2501
14 lbs

Collaborative Stools - Square

COM 1.9 yd
0.5 yd COM per seat
1.4 yd COM for sides

| MODEL | COM | GR1 | GR2 | GR3 | GR4 | GR5 | GR6 |
|-------------|------------|------------|------------|------------|------------|------------|------------|
| 2502 | 465 | 568 | 602 | 673 | 778 | 859 | 966 |

Dimensions (inches)
seat H 18 total W 18 depth 18

CAL 133, add \$158 List per stool



2502
23 lbs

Collaborative Stools - Crescent

COM 1.3 yd
0.5 yd COM per seat
0.8 yd COM for sides

| MODEL | COM | GR1 | GR2 | GR3 | GR4 | GR5 | GR6 |
|-------------|------------|------------|------------|------------|------------|------------|------------|
| 2503 | 497 | 556 | 576 | 616 | 676 | 722 | 783 |

Dimensions (inches)
seat H 18 DIA 16

CAL 133, add \$158 List per stool



2503
13 lbs

CALVIN Public Seating

LAYOUTS



Description

- Spec's Calvin offers an oval steel frame with either wood or aluminum side rails.
- Your layout possibilities are unlimited with spacer, radius and corner tables for both standard and bariatric seating in virtually any combination.
- Bariatric seating is a 30" wide seat and is load tested to 750 lbs. Cannot be connected to other bariatric seats.
- 21" seat width is standard.
- Choice of wood or polyurethane arms.
- Wood and polyurethane arms are replaceable in the field.
- Two and three seat models offer a choice of no center arms or half arms between seats.
- Glides and separate seat and back are standard.
- Please send a drawing of the configuration you require with your order.
- Ships assembled as one, two and three seater units.
- For fabrics you wish railroaded or repeats larger than 5" x 5", please contact the factory with repeat information and yardage requirement will be provided.



LAYOUTS AND DIMENSIONS

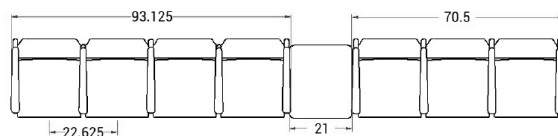
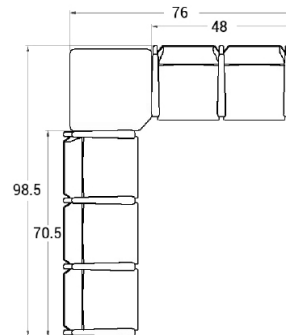
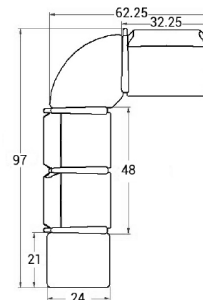

CALVIN Public Seating



PRODUCT CODE

8101M

Series
81 : Calvin

Center Arm
0 : No center arm
1 : Half arms

Seats
1 : Single Seat
2 : Two-Seat
3 : Three-Seat

Chair Type
M : Mid Back
H : Highback
G : Bariatric
L : Loveseat
ME : Hip Chair

OPTIONS

SIDE RAIL



Wood



Aluminium

ARMS



Wood



Polyurethane

FINISHES

FRAME



Select from one of our 76 standard Spectone colors

FABRIC



Select fabrics from one of our textile partners

ARMS



Black

Sterling Grey

Taupe

Select from one of our 9 standard wood stains or stain-to-match at no upcharge

See Spectone Card or specfurniture.com/materials/finishes for a complete list of finish options and colors.



CALVIN Public Seating

BACK TO CONTENTS

HOW TO ORDER

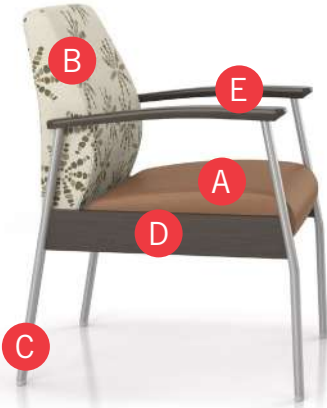

Specify Model

- A** Specify Fabric - Seat
Manufacturer, Pattern Name, Color
- B** Specify Fabric - Back
Manufacturer, Pattern Name, Color
- C** Specify Frame Finish
- D** Specify Side Rail Type and Color
- E** Specify Arm Type and Color

Optional: Wood Side Frame, CAL 133, Moisture Barrier, Connecting and Freestanding Tables, Vinyl Headrest Insert

| Model | Fabric - Seat | Fabric - Back | Frame Finish | Side Rail Type and Color | Arm Type and Color |
|-------|-------------------------|---------------------------|--------------|----------------------------|----------------------------|
| 8101M | Momentum, Icon, Lacquer | Momentum, Estrella, Lumen | Silver | Wood, Asian Night Stain | Wood, Asian Night Stain |





CALVIN Public Seating

Single Seater with arms

Standard Features

- Separate seat and back
- Polyurethane arms or wood arms
- Arms are field replaceable
- Wall-saving, 14 gauge oval tube frame
- Frame in any Spectone color
- Velcro removable back covers, replaceable seat
- Used in connected layouts at no upcharge
- Glides
- Ships assembled
- Ships 1/carton 15 cu ft

Contact Spec Customer Service to railroad fabrics (specify repeat info and yardage requirement will be provided) and for repeats greater than 5" x 5"

Options

- Choose aluminum (A) or wood (W) side frame. Aluminum side frame available in any Spectone color.
- For wood (W) side frame, specify and add \$120 list. Available in any of 9 standard stains or stain-to-match at no upcharge
- Polyurethane arms available in Black, Sterling Grey or Taupe (RAL 7006)
- Wood arms in Beech are available in any of 9 standard stains or stain-to-match at no upcharge
- Connected and freestanding tables
- Antibacterial and antimicrobial fabrics available
- Different fabric on seat and back at no upcharge
- CAL 133



Single Seater with arms

COM 1.75 yds
 0.75 yd COM per single seat
 1.0 yd COM per single back

| MODEL | COM | GR 1 | GR 2 | GR 3 | GR 4 | GR 5 | GR 6 |
|--------------|------------|-------------|-------------|-------------|-------------|-------------|-------------|
| 8101M | 985 | 1091 | 1122 | 1197 | 1298 | 1380 | 1488 |

Dimensions (inches)

| | | | | | |
|---------|-------|---------|------|-------|------|
| seat H | 18.0 | seat W | 21.0 | arm H | 25.0 |
| total H | 33.75 | total W | 25.0 | depth | 26.0 |

Exceeds BIFMA Seating Durability Test to 500 lbs per chair
 CAL 133, add \$120 List per chair



8101M
44 lbs

CALVIN Public Seating

Two and Three Seaters with outside arms

Standard Features

- Separate seat and back
- Polyurethane arms or wood arms
- Arms are field replaceable
- Wall-saving, 14 gauge oval tube frame
- Frame in any Spectone color
- Velcro removable back covers, replaceable seat
- Used in connected layouts at no upcharge
- Glides
- Ships assembled as 2 or 3 seaters
- Ships 1/carton 26 cu ft (2 seater), 1/carton 39 cu ft (3 seater)

Options

- Choose aluminum (A) or wood (W) side frame. Aluminum side frame available in any Spectone color.
- For wood (W) side frame, specify and add \$120 list. Available in any of 9 standard stains or stain-to-match at no upcharge
- Polyurethane arms available in Black, Sterling Grey or Taupe (RAL 7006)
- Wood arms in Beech are available in any of 9 standard stains or stain-to-match at no upcharge
- Connected and freestanding tables
- Antibacterial and antimicrobial fabrics available
- Different fabric on seat and back at no upcharge
- CAL 133

Contact Spec Customer Service to railroad fabrics (specify repeat info and yardage requirement will be provided) and for repeats greater than 5" x 5"

Two Seater with outside arms

COM 3.5 yds
0.75 yd COM per single seat
1.0 yd COM per single back

| MODEL | COM | GR 1 | GR 2 | GR 3 | GR 4 | GR 5 | GR 6 |
|--------------|-------------|-------------|-------------|-------------|-------------|-------------|-------------|
| 8102M | 1576 | 1787 | 1853 | 2002 | 2205 | 2368 | 2581 |

Dimensions (inches)

| | | | | | |
|---------|-------|---------|-------|-------|------|
| seat H | 18.0 | seat W | 21.0 | arm H | 25.0 |
| total H | 33.75 | total W | 44.75 | depth | 26.0 |

Exceeds BIFMA Seating Durability Test to 750 lbs per two seater
CAL 133, add \$240 List per two seater



8102M
73 lbs

Three Seater with outside arms

COM 5.25 yds
0.75 yd COM per single seat
1.0 yd COM per single back

| MODEL | COM | GR 1 | GR 2 | GR 3 | GR 4 | GR 5 | GR 6 |
|--------------|-------------|-------------|-------------|-------------|-------------|-------------|-------------|
| 8103M | 2105 | 2420 | 2520 | 2741 | 3046 | 3292 | 3614 |

Dimensions (inches)

| | | | | | |
|---------|-------|---------|------|-------|------|
| seat H | 18.0 | seat W | 21.0 | arm H | 25.0 |
| total H | 33.75 | total W | 67.5 | depth | 26.0 |

Exceeds BIFMA Seating Durability Test to 1000 lbs per three seater
CAL 133, add \$360 List per three seater



8103M
102 lbs



CALVIN Public Seating

Two and Three Seaters with half arms

Standard Features

- Separate seat and back
- Polyurethane arms or wood arms
- Arms are field replaceable
- Wall-saving, 14 gauge oval tube frame
- Frame in any Spectone color
- Velcro removable back covers, replaceable seat
- Used in connected layouts at no upcharge
- Glides
- Ships assembled as 2 or 3 seaters
- Ships 1/carton 26 cu ft (2 seater),
1/carton 39 cu ft (3 seater)

Options

- Choose aluminum (A) or wood (W) side frame. Aluminum side frame available in any Spectone color.
- For wood (W) side frame, specify and add \$120 list. Available in any of 9 standard stains or stain-to-match at no upcharge
- Polyurethane arms available in Black, Sterling Grey or Taupe (RAL 7006)
- Wood arms in Beech are available in any of 9 standard stains or stain-to-match at no upcharge
- Connected and freestanding tables
- Antibacterial and antimicrobial fabrics available
- Different fabric on seat and back at no upcharge
- CAL 133

Contact Spec Customer Service to railroad fabrics (specify repeat info and yardage requirement will be provided) and for repeats greater than 5" x 5"



Two Seater with half arms

COM 3.5 yds
0.75 yd COM per single seat
1.0 yd COM per single back

| MODEL | COM | GR 1 | GR 2 | GR 3 | GR 4 | GR 5 | GR 6 |
|--------------|-------------|-------------|-------------|-------------|-------------|-------------|-------------|
| 8112M | 1768 | 1978 | 2045 | 2192 | 2396 | 2560 | 2775 |

Dimensions (inches)

| | | | | | |
|---------|-------|---------|------|-------|------|
| seat H | 18.0 | seat W | 21.0 | arm H | 25.0 |
| total H | 33.75 | total W | 48.0 | depth | 26.0 |

Exceeds BIFMA Seating Durability Test to 750 lbs per two seater
CAL 133, add \$240 List per two seater



8112M
74 lbs

Three Seater with half arms

COM 5.25 yds
0.75 yd COM per single seat
1.0 yd COM per single back

| MODEL | COM | GR 1 | GR 2 | GR 3 | GR 4 | GR 5 | GR 6 |
|--------------|-------------|-------------|-------------|-------------|-------------|-------------|-------------|
| 8113M | 2456 | 2774 | 2872 | 3095 | 3398 | 3644 | 3967 |

Dimensions (inches)

| | | | | | |
|---------|-------|---------|------|-------|------|
| seat H | 18.0 | seat W | 21.0 | arm H | 25.0 |
| total H | 33.75 | total W | 70.5 | depth | 26.0 |

Exceeds BIFMA Seating Durability Test to 1000 lbs per two seater
CAL 133, add \$360 List per three seater



8113M
103 lbs



CALVIN Public Seating

Loveseat with arms

Standard Features

- Separate seat and back
- Polyurethane arms or wood arms
- Arms are field replaceable
- Wall-saving, 14 gauge oval tube frame
- Frame in any Spectone color
- Velcro removable back covers, replaceable seat
- Used in connected layouts at no upcharge
- Glides
- Ships assembled
- Ships 1/carton 20 cu ft

Contact Spec Customer Service to railroad fabrics (specify repeat info and yardage requirement will be provided) and for repeats greater than 5" x 5"

Options

- Choose aluminum (A) or wood (W) side frame. Aluminum side frame available in any Spectone color.
- For wood (W) side frame, specify and add \$120 list. Available in any of 9 standard stains or stain-to-match at no upcharge
- Polyurethane arms available in Black, Sterling Grey or Taupe (RAL 7006)
- Wood arms in Beech are available in any of 9 standard stains or stain-to-match at no upcharge
- Connected and freestanding tables
- Antibacterial and antimicrobial fabrics available
- Different fabric on seat and back at no upcharge
- CAL 133



Loveseat with arms

COM 3.5 yds
 1.75 yd COM per single seat
 1.75 yd COM per single back

| MODEL | COM | GR 1 | GR 2 | GR 3 | GR 4 | GR 5 | GR 6 |
|--------------|-------------|-------------|-------------|-------------|-------------|-------------|-------------|
| 8101L | 1486 | 1695 | 1763 | 1912 | 2114 | 2279 | 2493 |

Dimensions (inches)

| | | | | | |
|---------|-------|---------|------|-------|------|
| seat H | 18.0 | seat W | 42.0 | arm H | 25.0 |
| total H | 33.75 | total W | 46.0 | depth | 26.0 |

Exceeds BIFMA Seating Durability Test to 750 lbs per chair
 CAL 133, add \$184 List per chair



8101L
73 lbs



CALVIN Public Seating

Bariatric Single Seater with arms

Standard Features

- Separate seat and back
- Polyurethane arms or wood arms
- Arms are field replaceable
- Wall-saving, 14 gauge oval tube frame
- Frame in any Spectone color
- Velcro removable back covers, replaceable seat
- Used in connected layouts at no upcharge
- Glides
- Ships assembled
- Ships 1/carton 20 cu ft

Contact Spec Customer Service to railroad fabrics (specify repeat info and yardage requirement will be provided) and for repeats greater than 5" x 5"

Options

- Choose aluminum (A) or wood (W) side frame. Aluminum side frame available in any Spectone color.
- For wood (W) side frame, specify and add \$120 list. Available in any of 9 standard stains or stain-to-match at no upcharge
- Polyurethane arms available in Black, Sterling Grey or Taupe (RAL 7006)
- Wood arms in Beech are available in any of 9 standard stains or stain-to-match at no upcharge
- Connected and freestanding tables
- Antibacterial and antimicrobial fabrics available
- Different fabric on seat and back at no upcharge
- CAL 133



Bariatric Single Seater with arms

COM 3.0 yds
 1.5 yd COM per single seat
 1.5 yd COM per single back

| MODEL | COM | GR 1 | GR 2 | GR 3 | GR 4 | GR 5 | GR 6 |
|--------------|-------------|-------------|-------------|-------------|-------------|-------------|-------------|
| 8101G | 1197 | 1378 | 1434 | 1562 | 1736 | 1876 | 2060 |

Dimensions (inches)

| | | | | | |
|---------|-------|---------|------|-------|------|
| seat H | 18.0 | seat W | 30.0 | arm H | 25.0 |
| total H | 33.75 | total W | 34.0 | depth | 26.0 |

Exceeds BIFMA Seating Durability Test to 750 lbs per chair
 CAL 133, add \$150 List per chair



8101G
53 lbs



CALVIN Public Seating

Highback Single Seater with arms

Standard Features

- Separate seat and back
- Polyurethane arms or wood arms
- Arms are field replaceable
- 14 gauge oval tube frame
- Frame in any Spectone color
- Velcro removable back covers, replaceable seat
- Used in connected layouts at no upcharge
- Glides
- Ships assembled
- Ships 1/carton 20 cu ft

Contact Spec Customer Service to railroad fabrics (specify repeat info and yardage requirement will be provided) and for repeats greater than 5" x 5"

Options

- Choose aluminum (A) or wood (W) side frame. Aluminum side frame available in any Spectone color.
- For wood (W) side frame, specify and add \$120 list. Available in any of 9 standard stains or stain-to-match at no upcharge
- Polyurethane arms available in Black, Sterling Grey or Taupe (RAL 7006)
- Wood arms in Beech are available in any of 9 standard stains or stain-to-match at no upcharge
- Vinyl insert on top of the back, add \$44 List/seat back
- Connected and freestanding tables
- Antibacterial and antimicrobial fabrics available
- Different fabric on seat and back at no upcharge
- CAL 133



Highback Single Seater with arms

COM 2.5 yds
 0.75 yd COM per single seat
 1.75 yd COM per single back

| MODEL | COM | GR 1 | GR 2 | GR 3 | GR 4 | GR 5 | GR 6 |
|--------------|-------------|-------------|-------------|-------------|-------------|-------------|-------------|
| 8101H | 1062 | 1213 | 1260 | 1367 | 1511 | 1629 | 1782 |

Dimensions (inches)

| | | | | | |
|---------|-------|---------|------|-------|------|
| seat H | 18.0 | seat W | 21.0 | arm H | 25.0 |
| total H | 47.50 | total W | 25.0 | depth | 26.0 |

Exceeds BIFMA Seating Durability Test to 500 lbs per chair
 CAL 133, add \$134 List per chair



8101H
50 lbs



CALVIN Public Seating

Easy Access Hip Single Seater with arms

Standard Features

- Separate seat and back
- Polyurethane arms or wood arms
- Arms are field replaceable
- Wall-saving, 14 gauge oval tube frame
- Frame in any Spectone color
- Velcro removable back covers, replaceable seat
- Used in connected layouts at no upcharge
- Glides
- Ships assembled
- Ships 1/carton 20 cu ft

Contact Spec Customer Service to railroad fabrics (specify repeat info and yardage requirement will be provided) and for repeats greater than 5" x 5"

Options

- Choose aluminum (A) or wood (W) side frame. Aluminum side frame available in any Spectone color.
- For wood (W) side frame, specify and add \$120 list. Available in any of 9 standard stains or stain-to-match at no upcharge
- Polyurethane arms available in Black, Sterling Grey or Taupe (RAL 7006)
- Wood arms in Beech are available in any of 9 standard stains or stain-to-match at no upcharge
- Connected and freestanding tables
- Antibacterial and antimicrobial fabrics available
- Different fabric on seat and back at no upcharge
- CAL 133



Easy Access Hip Single Seater with arms

COM 1.75 yds
 0.75 yd COM per single seat
 1.0 yd COM per single back

| MODEL | COM | GR 1 | GR 2 | GR 3 | GR 4 | GR 5 | GR 6 |
|---------------|-------------|-------------|-------------|-------------|-------------|-------------|-------------|
| 8101ME | 1091 | 1195 | 1227 | 1302 | 1404 | 1486 | 1594 |

Dimensions (inches)

| | | | | | |
|---------|------|---------|------|-------|------|
| seat H | 24.0 | seat W | 21.0 | arm H | 31.5 |
| total H | 46.0 | total W | 25.0 | depth | 26.0 |

Exceeds BIFMA Seating Durability Test to 500 lbs per chair
 CAL 133, add \$120 List per chair



8101ME
47 lbs

CALVIN Public Seating

Freestanding Lounge Tables – Corner and Spacer Connecting Tables

Standard Features

- Tops in laminate or veneer
- Select laminate tops from 15 standard laminates or choose any standard Wilsonart, Nevamar, Formica, Arborite and Pionite matte finish laminates at no upcharge.
- Freestanding lounge tables available with PVC Flat (PVF), 2mm (2MM), exposed Baltic Birch plywood (PF, PKNR) or hardwood (HB) edge
- Connecting table tops available with PVC Flat (PVF) edge, Self edge (SE) or hardwood (HB) edge
- 9 standard veneer and hardwood edge stains. Stain-to-match available at no upcharge.
- Oval steel table legs available in any Spectone color
- Tops utilize NU Green earth friendly core
- Threaded replaceable glides
- 18" height

Options

- Non-standard laminates, contact Spec for pricing
- Custom size spacer tables for restricted spaces
- Other sizes may be available

Radius Corner Tables are recommended for open areas

Freestanding Lounge Tables

| Model | Laminate PVF/SE/2MM | Laminate PF/PKNR/HB | Veneer HB | Weight | Cu.Ft. |
|-----------------|------------------------|------------------------|--------------|--------|--------|
| 81 - 24 x 24 SQ | 639 | 833 | 988 | 47 | 7.2 |
| 81 - 24 x 48 RE | 800 | 1014 | 1232 | 64 | 18 |
| 81 - 30 x 30 SQ | 746 | 887 | 1052 | 57 | 13.5 |
| 81 - 22 DIA | 799 | 1159 | 1363 | 47 | 7.2 |



Corner and Spacer Connecting Tables

| Model | Laminate PVF/SE | Laminate HB Edge | Veneer HB Edge | Weight | Cu.Ft. |
|--|--------------------|---------------------|-------------------|--------|--------|
| 81RC - 28 x 28 <i>Radius Corner Table</i> | 832 | 1116 | 1308 | 26 | 2 |
| 81SC - 28 x 28 <i>Square Corner Table</i> | 909 | 1104 | 1218 | 26 | 2 |
| 81TC - 45 degree <i>Corner Table</i> | 832 | 1116 | 1308 | 19 | 2 |
| 81ST - 21 x 21 <i>Spacer Table</i> | 565 | 797 | 913 | 19 | 2 |
| 81ET - 21 x 21 <i>End Table</i> | 754 | 986 | 1103 | 19 | 2 |

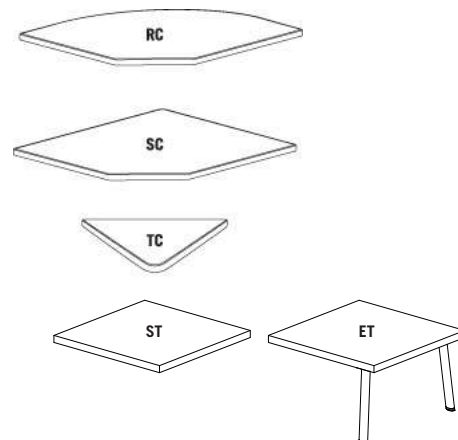

SOLID EDGE HOME USE

COMPANION Lounge Seating

LAYOUTS



Description

- Spec presents the high performance Companion Series, offering warmth, durability, value and an unbeatable array of options and features.
- Your layout possibilities are unlimited with spacer, radius and corner tables – for both standard and bariatric seating in virtually any combination.
- Bariatric seating is a 30" wide seat and is load tested to 750 lbs. Cannot be connected to other bariatric seats.
- Velcro removable seats and backs are standard.
- 21" seat width is standard.
- Choice of wood or polyurethane arms which are replaceable in the field.
- High and medium back contours fit perfectly and provide exceptional comfort.
- All models offer a choice of no center arms, half arms or full arms to the floor.
- A 5° seat pitch is standard. An optional 7° pitch can be specified at no upcharge. A 3° pitch may be specified at an upcharge.
- 1.75" diameter wall-saving frame is standard to protect both wall and fabric.
- Rear glides and separate seat and back are standard.
- Please send a drawing of the configuration you require with your order.
- For fabrics you wish railroaded or repeats larger than 5" x 5", please contact the factory with repeat information and yardage requirement will be provided.



LAYOUTS AND DIMENSIONS

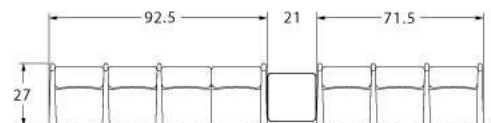
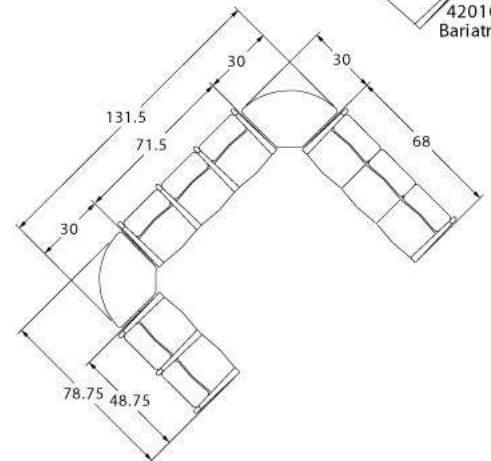
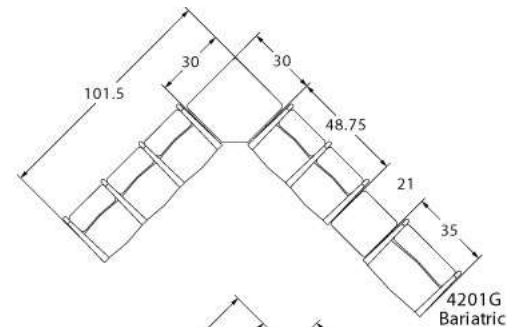

COMPANION Lounge Seating



PRODUCT CODE

4201M

Series

42 : Companion

Arm/Other

- 0 : Outside Arms
- 1 : Half Arms
- 2 : Full Arms
- 3 : Easy Access Hip Chair

Number of Seats

- 1 : Single Seater
- 2 : Two Seater
- 3 : Three Seater

Chair Type

- M : Mid Back
- H : Highback
- G : Bariatric
- ME : Hip Chair

OPTIONS

SEAT PITCH



3°, 5° (standard) or 7° Seat Pitch

ARM TYPE



Polyurethane

Wood

HALF PANEL ARM



FINISHES

FRAME



Select from one of our 76 standard Spectone colors

FABRIC



Select fabrics from one of our textile partners

ARMS



Black

Sterling Grey

Taupe

Select from one of our 9 standard wood stains or stain-to-match at no upcharge

See Spectone Card or specfurniture.com/materials/finishes for a complete list of finish options and colors.



COMPANION Lounge Seating

BACK TO CONTENTS

HOW TO ORDER

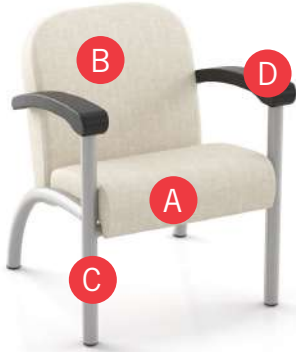

Specify Model

- A** Specify Fabric - Seat¹
Manufacturer, Pattern Name, Color
- B** Specify Fabric - Back¹
Manufacturer, Pattern Name, Color
- C** Specify Frame Finish
- D** Specify Arm Type and Color

Optional: 3°/7° Seat Pitch, CAL 133, Moisture Barrier, Half Panel Arm, Connecting and Freestanding Tables, Ottoman, Vinyl Headrest Insert

¹ When multiple fabrics are specified on two and three seat chairs, please provide a drawing and legend for fabric placement.

| Model | Fabric - Seat | Fabric - Back | Frame Finish | Arm Type and Color | Seat Pitch |
|-------|---------------------------|---------------------------|--------------|---------------------|------------|
| 4201M | Momentum, Beeline, Canvas | Momentum, Beeline, Canvas | Silver | Polyurethane, Black | 5° |





COMPANION Lounge Seating

Medium Back Single Seater with arms

Standard Features

- Separate seat and back
- Polyurethane arms or wood arms
- Fully welded 1.75" frame
- Frame in any Spectone color
- Velcro removable seat and back covers
- 5° seat pitch
- Use in connected layouts at no upcharge
- Glides
- Arms replaceable in the field
- Ships assembled
- Ships 1/carton 15 cu ft

Options

- Polyurethane arms are available in Black, Sterling Grey and Taupe (RAL 7006)
- Wood arms are available in 9 standard stains and stain-to-match at no upcharge
- 7° seat pitch at no upcharge; 3° seat pitch, add \$24 List/seat
- Connected and freestanding tables
- Antibacterial and antimicrobial fabrics available
- Different fabric on seat and back at no upcharge
- CAL 133

Contact Spec Customer Service to railroad fabrics (specify repeat info and yardage requirement will be provided) and for repeats greater than 5" x 5"



Medium Back Single Seater with arms

COM 2.0 yds
1.0 yd COM per single seat
1.0 yd COM per single back

| MODEL | COM | GR 1 | GR 2 | GR 3 | GR 4 | GR 5 | GR 6 |
|--------------|-------------|-------------|-------------|-------------|-------------|-------------|-------------|
| 4201M | 1171 | 1286 | 1323 | 1402 | 1513 | 1602 | 1717 |

Dimensions (inches)

| | | | | | |
|---------|------|---------|------|-------|------|
| seat H | 18.0 | seat W | 21.0 | arm H | 27.0 |
| total H | 32.5 | total W | 26.0 | depth | 27.0 |

Exceeds BIFMA Seating Durability Test to 500 lbs per chair
CAL 133, add \$108 List per chair



4201M
45 lbs



COMPANION Lounge Seating

Medium Back Two and Three Seaters with outside arms

Standard Features

- Separate seat and back
- Polyurethane arms or wood arms
- Fully welded 1.75" frame
- Frame in any Spectone color
- Velcro removable seat and back covers
- 5° seat pitch
- Use in connected layouts at no upcharge
- Glides
- Arms replaceable in the field
- Ships assembled
- Ships 1/carton 26 cu ft (2 seater), 1/carton 39 cu ft (3 seater)

Options

- Polyurethane arms are available in Black, Sterling Grey and Taupe (RAL 7006)
- Wood arms are available in 9 standard stains and stain-to-match at no upcharge
- 7° seat pitch at no upcharge; 3° seat pitch, add \$24 List/seat
- Connected and freestanding tables
- Antibacterial and antimicrobial fabrics available
- Different fabric on seat and back at no upcharge
- CAL 133

Contact Spec Customer Service to railroad fabrics (specify repeat info and yardage requirement will be provided) and for repeats greater than 5" x 5"



Medium Back Two Seater with outside arms

COM 4.0 yds
1.0 yd COM per single seat
1.0 yd COM per single back

| MODEL | COM | GR 1 | GR 2 | GR 3 | GR 4 | GR 5 | GR 6 |
|--------------|-------------|-------------|-------------|-------------|-------------|-------------|-------------|
| 4202M | 1792 | 2023 | 2100 | 2251 | 2482 | 2655 | 2884 |

Dimensions (inches)

| | seat H | 18.0 | seat W | 21.0 | arm H | 27.0 |
|---------|--------|---------|--------|-------|-------|------|
| total H | 32.5 | total W | 47.0 | depth | 27.0 | |

Exceeds BIFMA Seating Durability Test to 500 lbs per two seater
CAL 133, add \$216 List per two seater



4202M
75 lbs

Medium Back Three Seater with outside arms

COM 6.0 yds
1.0 yd COM per single seat
1.0 yd COM per single back

| MODEL | COM | GR 1 | GR 2 | GR 3 | GR 4 | GR 5 | GR 6 |
|--------------|-------------|-------------|-------------|-------------|-------------|-------------|-------------|
| 4203M | 2432 | 2775 | 2890 | 3119 | 3461 | 3724 | 4067 |

Dimensions (inches)

| | seat H | 18.0 | seat W | 21.0 | arm H | 27.0 |
|---------|--------|---------|--------|-------|-------|------|
| total H | 32.5 | total W | 68.0 | depth | 27.0 | |

Exceeds BIFMA Seating Durability Test to 500 lbs per three seater
CAL 133, add \$324 List per three seater



4203M
105 lbs

COMPANION Lounge Seating

Medium Back Two and Three Seaters with half arms

Standard Features

- Separate seat and back
- Polyurethane arms or wood arms
- Fully welded 1.75" frame
- Frame in any Spectone color
- Velcro removable seat and back covers
- 5° seat pitch
- Use in connected layouts at no upcharge
- Glides
- Arms replaceable in the field
- Ships assembled
- Ships 1/carton 26 cu ft (2 seater),
1/carton 39 cu ft (3 seater)

Options

- Polyurethane arms are available in Black, Sterling Grey and Taupe (RAL 7006)
- Wood arms are available in 9 standard stains and stain-to-match at no upcharge
- 7° seat pitch at no upcharge; 3° seat pitch, add \$24 List/seat
- Connected and freestanding tables
- Antibacterial and antimicrobial fabrics available
- Different fabric on seat and back at no upcharge
- CAL 133

Contact Spec Customer Service to railroad fabrics (specify repeat info and yardage requirement will be provided) and for repeats greater than 5" x 5"

Medium Back Two Seater with half arms

COM 4.0 yds
1.0 yd COM per single seat
1.0 yd COM per single back

| MODEL | COM | GR 1 | GR 2 | GR 3 | GR 4 | GR 5 | GR 6 |
|--------------|-------------|-------------|-------------|-------------|-------------|-------------|-------------|
| 4212M | 2006 | 2236 | 2313 | 2464 | 2693 | 2866 | 3099 |

Dimensions (inches)

| | seat H | 18.0 | seat W | 21.0 | arm H | 27.0 |
|---------|--------|---------|--------|-------|-------|------|
| total H | 32.5 | total W | 48.75 | depth | 27.0 | |

Exceeds BIFMA Seating Durability Test to 500 lbs per two seater
CAL 133, add \$216 List per two seater



4212M
79 lbs

Medium Back Three Seater with half arms

COM 6.0 yds
1.0 yd COM per single seat
1.0 yd COM per single back

| MODEL | COM | GR 1 | GR 2 | GR 3 | GR 4 | GR 5 | GR 6 |
|--------------|-------------|-------------|-------------|-------------|-------------|-------------|-------------|
| 4213M | 2775 | 3116 | 3232 | 3461 | 3805 | 4067 | 4412 |

Dimensions (inches)

| | seat H | 18.0 | seat W | 21.0 | arm H | 27.0 |
|---------|--------|---------|--------|-------|-------|------|
| total H | 32.5 | total W | 71.5 | depth | 27.0 | |

Exceeds BIFMA Seating Durability Test to 500 lbs per three seater
CAL 133, add \$324 List per three seater



4213M
114 lbs



COMPANION Lounge Seating

Medium Back Two and Three Seaters with full arms

Standard Features

- Separate seat and back
- Polyurethane arms or wood arms
- Fully welded 1.75" frame
- Frame in any Spectone color
- Velcro removable seat and back covers
- 5° seat pitch
- Use in connected layouts at no upcharge
- Glides
- Arms replaceable in the field
- Ships assembled
- Ships 1/carton 26 cu ft (2 seater),
1/carton 39 cu ft (3 seater)

Options

- Polyurethane arms are available in Black, Sterling Grey and Taupe (RAL 7006)
- Wood arms are available in 9 standard stains and stain-to-match at no upcharge
- 7° seat pitch at no upcharge; 3° seat pitch, add \$24 List/seat
- Connected and freestanding tables
- Antibacterial and antimicrobial fabrics available
- Different fabric on seat and back at no upcharge
- CAL 133

Contact Spec Customer Service to railroad fabrics (specify repeat info and yardage requirement will be provided) and for repeats greater than 5" x 5"



Medium Back Two Seater with full arms

COM 4.0 yds
1.0 yd COM per single seat
1.0 yd COM per single back

| MODEL | COM | GR 1 | GR 2 | GR 3 | GR 4 | GR 5 | GR 6 |
|--------------|-------------|-------------|-------------|-------------|-------------|-------------|-------------|
| 4222M | 2036 | 2265 | 2343 | 2495 | 2725 | 2897 | 3127 |

Dimensions (inches)

| | seat H | 18.0 | seat W | 21.0 | arm H | 27.0 |
|---------|--------|---------|--------|-------|-------|------|
| total H | 32.5 | total W | 48.75 | depth | 27.0 | |

Exceeds BIFMA Seating Durability Test to 500 lbs per two seater
CAL 133, add \$216 List per two seater



4222M
82 lbs

Medium Back Three Seater with full arms

COM 6.0 yds
1.0 yd COM per single seat
1.0 yd COM per single back

| MODEL | COM | GR 1 | GR 2 | GR 3 | GR 4 | GR 5 | GR 6 |
|--------------|-------------|-------------|-------------|-------------|-------------|-------------|-------------|
| 4223M | 2917 | 3261 | 3378 | 3607 | 3951 | 4213 | 4555 |

Dimensions (inches)

| | seat H | 18.0 | seat W | 21.0 | arm H | 27.0 |
|---------|--------|---------|--------|-------|-------|------|
| total H | 32.5 | total W | 71.5 | depth | 27.0 | |

Exceeds BIFMA Seating Durability Test to 500 lbs per three seater
CAL 133, add \$324 List per three seater



4223M
120 lbs



COMPANION Lounge Seating

Medium Back Bariatric Single Seater with arms

Standard Features

- Separate seat and back
- Polyurethane arms or wood arms
- Fully welded 1.75" frame
- Frame in any Spectone color
- Velcro removable seat and back covers
- 5° seat pitch
- Use in connected layouts at no upcharge
- Glides
- Arms replaceable in the field
- Cannot connect bariatric seating to bariatric seating
- Ships assembled
- Ships 1/carton 20 cu ft

Options

- Polyurethane arms are available in Black, Sterling Grey and Taupe (RAL 7006)
- Wood arms are available in 9 standard stains and stain-to-match at no upcharge
- Connected and freestanding tables
- Antibacterial and antimicrobial fabrics available
- Different fabric on seat and back at no upcharge
- CAL 133

Contact Spec Customer Service to railroad fabrics (specify repeat info and yardage requirement will be provided) and for repeats greater than 5" x 5"



Medium Back Bariatric Single Seater with arms

COM 3.25 yds
 1.5 yd COM per single seat
 1.75 yd COM per single back

| MODEL | COM | GR 1 | GR 2 | GR 3 | GR 4 | GR 5 | GR 6 |
|--------------|-------------|-------------|-------------|-------------|-------------|-------------|-------------|
| 4201G | 1387 | 1583 | 1648 | 1780 | 1975 | 2126 | 2323 |

Dimensions (inches)

| | | | | | |
|---------|------|---------|------|-------|------|
| seat H | 18.0 | seat W | 30.0 | arm H | 27.0 |
| total H | 32.5 | total W | 35.0 | depth | 27.0 |

Exceeds BIFMA Seating Durability Test to 750 lbs per chair
 CAL 133, add \$163 List per chair



4201G
56 lbs



COMPANION Lounge Seating

Highback Single Seater with arms
Ottoman

Standard Features

- Separate seat and back
- Polyurethane arms or wood arms
- Fully welded 1.75" frame
- Frame in any Spectone color
- Velcro removable seat and back covers
- 5° seat pitch
- Use in connected layouts at no upcharge
- Glides
- Arms replaceable in the field
- Ships assembled
- Ships 1/carton 19 cu ft
- Ottoman ships 1/carton 5 cu ft

Options

- Polyurethane arms are available in Black, Sterling Grey and Taupe (RAL 7006)
- Wood arms are available in 9 standard stains and stain-to-match at no upcharge
- 7° seat pitch at no upcharge; 3° seat pitch, add \$24 List/seat
- Vinyl insert on top of the back, add \$44 List/seat back
- Connected and freestanding tables
- Antibacterial and antimicrobial fabrics available
- Different fabric on seat and back at no upcharge
- CAL 133

Contact Spec Customer Service to railroad fabrics (specify repeat info and yardage requirement will be provided) and for repeats greater than 5" x 5"



Highback Single Seater with arms

COM 2.25 yds
1.0 yd COM per single seat
1.25 yd COM per single back

| MODEL | COM | GR 1 | GR 2 | GR 3 | GR 4 | GR 5 | GR 6 |
|--------------|-------------|-------------|-------------|-------------|-------------|-------------|-------------|
| 4201H | 1232 | 1358 | 1402 | 1485 | 1612 | 1708 | 1834 |

Dimensions (inches)

| | seat H | 18.0 | seat W | 21.0 | arm H | 27.0 |
|---------|--------|---------|--------|-------|-------|------|
| total H | 45.0 | total W | 26.0 | depth | 27.0 | |

Exceeds BIFMA Seating Durability Test to 500 lbs per chair
CAL 133, add \$134 List per chair



4201H
48 lbs

Ottoman

0.5 yd COM per ottoman

| MODEL | COM | GR 1 | GR 2 | GR 3 | GR 4 | GR 5 | GR 6 |
|--------------|------------|------------|------------|------------|------------|------------|------------|
| 4230F | 422 | 456 | 468 | 492 | 527 | 555 | 602 |

Ottoman Dimensions (inches)

| H | 11.5 | W | 19.25 | depth | 12.25 |
|---|------|---|-------|-------|-------|
|---|------|---|-------|-------|-------|

CAL 133, add \$55 List



4230F
16 lbs



COMPANION Lounge Seating

Half Panel Arm

To order half panel arms, add Z to model number, e.g. 4201HZ

Pricing is for one half panel arm, e.g. for a single seater chair with half panel arms, add two half panel arms to cost of chair

Contact Spec Customer Service to railroad fabrics (specify repeat info and yardage requirement will be provided) and for repeats greater than 5" x 5"

Options

- Antibacterial and antimicrobial fabrics available
- CAL 133



Half Panel Arm

COM 0.5 yds per half panel arm

| MODEL | COM | GR 1 | GR 2 | GR 3 | GR 4 | GR 5 | GR 6 |
|----------|-----------|------------|------------|------------|------------|------------|------------|
| z | 94 | 127 | 137 | 165 | 207 | 233 | 261 |

CAL 133, add \$51 List per half panel arm



1.5 lbs per half panel arm



COMPANION Lounge Seating

Medium Back Easy Access Hip Single Seater with arms

Standard Features

- Separate seat and back
- Polyurethane arms or wood arms
- Fully welded 1.75" frame
- Frame in any Spectone color
- Velcro removable seat and back covers
- 24" seat height, 3° seat pitch
- Footrest which assists entering/exiting chair
- Glides
- Arms replaceable in the field
- Ships assembled
- Ships 1/carton 19 cu ft

Options

- Polyurethane arms are available in Black, Sterling Grey and Taupe (RAL 7006)
- Wood arms are available in 9 standard stains and stain-to-match at no upcharge
- Antibacterial and antimicrobial fabrics available
- Different fabric on seat and back at no upcharge
- CAL 133

Contact Spec Customer Service to railroad fabrics (specify repeat info and yardage requirement will be provided) and for repeats greater than 5" x 5"



Medium Back Easy Access Hip Single Seater with arms

COM 2.0 yds
 1.0 yd COM per single seat
 1.0 yd COM per single back

| MODEL | COM | GR 1 | GR 2 | GR 3 | GR 4 | GR 5 | GR 6 |
|---------------|-------------|-------------|-------------|-------------|-------------|-------------|-------------|
| 4231ME | 1280 | 1395 | 1431 | 1510 | 1622 | 1710 | 1825 |

Dimensions (inches)

| | | | | | |
|---------|-------|---------|------|-------|-------|
| seat H | 24.0 | seat W | 21.0 | arm H | 33.75 |
| total H | 39.75 | total W | 26.0 | depth | 27.0 |

Exceeds BIFMA Seating Durability Test to 500 lbs per chair
 CAL 133, add \$108 List per chair



4231ME
47 lbs

COMPANION Lounge Seating

Freestanding Lounge Tables
 Corner and Spacer Connecting Tables

Standard Features

- Tops in laminate or veneer
- Select laminate tops from 15 standard laminates or choose any standard Wilsonart, Nevamar, Formica, Arborite and Pionite matte finish laminates at no upcharge.
- Freestanding lounge tables available with PVC Flat (PVF), 2mm (2MM), exposed Baltic Birch plywood (PF, PKNR) or hardwood (HB) edge
- Connecting table tops available with PVC Flat (PVF) edge, Self edge (SE) or hardwood (HB) edge
- 9 standard veneer and hardwood edge stains. Stain-to-match available at no upcharge.
- Fully welded frame with 1.75" steel legs
- Frame in any Spectone color
- Tops utilize NU Green earth friendly core
- Glides
- 18" height

Options

- Non-standard laminates, contact Spec for pricing
- Custom size spacer tables for restricted spaces
- Other sizes may be available

Freestanding Lounge Tables

| Model | Laminate PVF/SE/2MM | Laminate PF/PKNR/HB | Veneer HB | Weight | Cu.Ft. |
|---------------|------------------------|------------------------|--------------|--------|--------|
| 42 - 24 DIA | 795 | 1154 | 1359 | 27 | 7.2 |
| 42 - 24x24 SQ | 826 | 1021 | 1175 | 30 | 7.2 |
| 42 - 24x48 RE | 988 | 1202 | 1420 | 44 | 18 |
| 42 - 30 DIA | 899 | 1253 | 1463 | 37 | 13.5 |
| 42 - 30x30 SQ | 933 | 1074 | 1241 | 40 | 13.5 |



Corner and Spacer Connecting Tables

| Model | Laminate PVF/SE | Weight | Cu.Ft. |
|---|--------------------|--------|--------|
| 42RC - 30x30 <i>Radius Corner Table</i> | 704 | 31 | 2 |
| 42SC - 30x30 <i>Square Corner Table</i> | 704 | 32 | 2 |
| 42TC45 - 19x23 <i>45 Degree Corner Table</i> | 704 | 26 | 2 |
| 42ST - 21x24 <i>Spacer or End Table</i> | 542 | 23 | 2 |

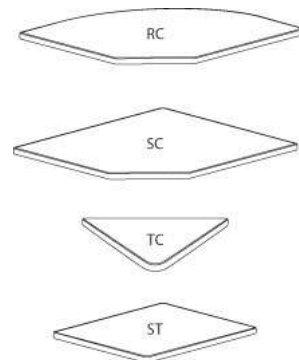

COOPER COLLECTION - BALA Lounge Seating

LAYOUTS



Description

- Spec's Bala offers the softer look and feel of wood, without sacrificing high durability.
- Your layout possibilities are unlimited with spacer, radius and corner tables – for both standard and bariatric seating in virtually any combination.
- Bariatric seating is a 30" wide seat and is load tested to 750 lbs. Cannot be connected to other bariatric seats.
- 21" seat width is standard.
- Standard in European Beech in any of 9 standard stains or stain-to-match at no upcharge.
- Choice of wood or polyurethane arms which are replaceable in the field.
- All models offer a choice of no center arms, half arms or full arms to the floor.
- Glides and separate seat and back are standard.
- Please send a drawing of the configuration you require with your order.
- For fabrics you wish railroaded or repeats larger than 5" x 5", please contact the factory with repeat information and yardage requirement will be provided.



LAYOUTS AND DIMENSIONS

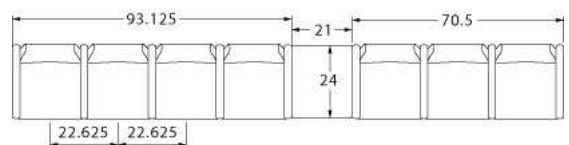
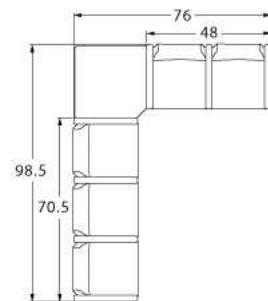
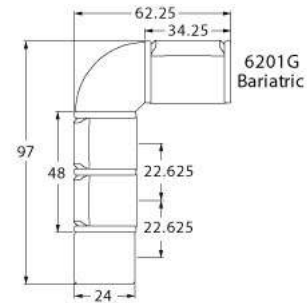

COOPER COLLECTION - BALA Lounge Seating



PRODUCT CODE

6 2 2 3 M - WF

| | | | | | |
|---------------------------------|---------------------------|---|---|---|---|
| Collection 6 : Cooper | Series 2 : Bala | Center Arm 0 : Outside Arms 1 : Half Arms 2 : Full Arms | Number of Seats 1 : Single Seater 2 : Two Seater 3 : Three Seater | Chair Type M : Mid Back H : Highback G : Bariatric ME : Hip Chair B : Bench BG : Bariatric Bench L : Loveseat | Arm Type and Profile WF : Wood Flat WR : Wood Round PF : Poly Flat PR : Poly Round K: KYDEX® Flat Profile |
|---------------------------------|---------------------------|---|---|---|---|



OPTIONS

ARM TYPE



Polyurethane

Wood

KYDEX®

PANEL ARMS

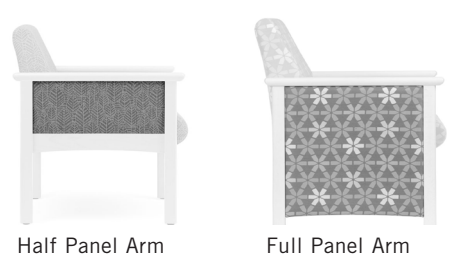

Half Panel Arm

Full Panel Arm

FINISHES

FRAME

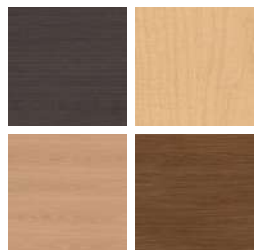

Select from one of our 9 standard wood stains or stain-to-match at no upcharge

FABRIC



Select fabrics from one of our textile partners

ARMS



Black

Sterling Grey

Taupe

Select from one of our 9 standard wood stains or stain-to-match at no upcharge

Note: flat polyurethane arm available in Black only.

See Spectone Card or specfurniture.com/materials/finishes for a complete list of finish options and colors.



COOPER COLLECTION - BALA Lounge Seating

BACK TO CONTENTS

HOW TO ORDER

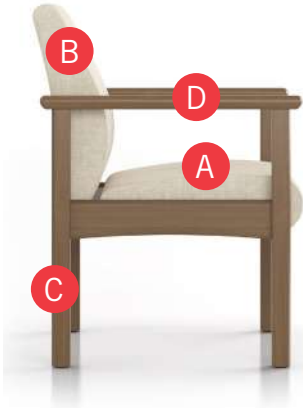

Specify Model

- A** Specify Fabric - Seat¹
Manufacturer, Pattern Name, Color
- B** Specify Fabric - Back¹
Manufacturer, Pattern Name, Color
- C** Specify Frame Finish
- D** Specify Arm Type, Profile and Color
Polyurethane (Flat or Round) / Wood (Flat or Round) / KYDEX® (\$) (Flat)

Optional: KYDEX® Arm, CAL 133, Moisture Barrier, Half or Full Panel Arms, Connecting and Freestanding Tables, Benches, Ottoman, Vinyl Headrest Insert

¹ When multiple fabrics are specified on two and three seat chairs, please provide a drawing and legend for fabric placement.



| Model | Fabric - Seat | Fabric - Back | Frame Finish | Arm Type, Profile and Color |
|-------|---------------------------|---------------------------|-------------------|-------------------------------|
| 6201M | Momentum, Beeline, Canvas | Momentum, Beeline, Canvas | Studio Teak Stain | Wood, Flat, Studio Teak Stain |



COOPER COLLECTION - BALA Lounge Seating

Designed for today's healthcare facilities
Single Seater with arms

Standard Features

- Separate seat and back
- Wood components in Beech, in any of 9 standard stains or stain-to-match at no upcharge
- Threaded replaceable glides
- Use in connected layouts at no upcharge
- Velcro removable back covers
- Replaceable seats
- Arms replaceable in the field
- Ships assembled
- Ships 1/carton 15 cu ft

Options

- Wood or polyurethane arms available in flat (WF or PF) or rounded (WR or PR) profile
- Round polyurethane arms available in Black, Sterling Grey and Taupe (RAL 7006)
- Flat polyurethane arms available in Black only
- KYDEX® flat arms available in Black (B) or Taupe RAL 7006 (T) or Sterling Grey (G)
- Connected and freestanding tables
- Antibacterial and antimicrobial fabrics available
- Different fabric on seat and back at no upcharge
- CAL 133

Contact Spec Customer Service to railroad fabrics (specify repeat info and yardage requirement will be provided) and for repeats greater than 5" x 5"



Single Seater with arms

COM 1.75 yds
0.75 yd COM per single seat
1.0 yd COM per single back

| MODEL | COM | GR 1 | GR 2 | GR 3 | GR 4 | GR 5 | GR 6 |
|--------------|-------------|-------------|-------------|-------------|-------------|-------------|-------------|
| 6201M | 1090 | 1180 | 1211 | 1270 | 1361 | 1429 | 1520 |

Dimensions (inches)

| | | | | | |
|---------|-------|---------|-------|-------|------|
| seat H | 18.0 | seat W | 21.0 | arm H | 25.0 |
| total H | 33.75 | total W | 25.25 | depth | 25.0 |

For KYDEX® flat arms add suffix K and \$274
Exceeds BIFMA Seating Durability Test to 500 lbs per chair
CAL 133, add \$120 List per chair



6201M
40 lbs



COOPER COLLECTION - BALA Lounge Seating

Designed for today's healthcare facilities
Two and Three Seaters with outside arms

Standard Features

- Separate seat and back
- Wood components in Beech, in any of 9 standard stains or stain-to-match at no upcharge
- Threaded replaceable glides
- Use in connected layouts at no upcharge
- Velcro removable back covers
- Replaceable seats
- Arms replaceable in the field
- Ships assembled
- Ships 1/carton 26 cu ft (2 seater), 1/carton 39 cu ft (3 seater)

Options

- Wood or polyurethane arms available in flat (WF or PF) or rounded (WR or PR) profile
- Round polyurethane arms available in Black, Sterling Grey and Taupe (RAL 7006)
- Flat polyurethane arms available in Black only
- KYDEX® flat arms available in Black (B) or Taupe RAL 7006 (T) or Sterling Grey (G)
- Connected and freestanding tables
- Antibacterial and antimicrobial fabrics available
- Different fabric on seat and back at no upcharge
- CAL 133

Contact Spec Customer Service to railroad fabrics (specify repeat info and yardage requirement will be provided) and for repeats greater than 5" x 5"



Two Seater with outside arms

COM 3.5 yds
0.75 yd COM per single seat
1.0 yd COM per single back

| MODEL | COM | GR 1 | GR 2 | GR 3 | GR 4 | GR 5 | GR 6 |
|--------------|-------------|-------------|-------------|-------------|-------------|-------------|-------------|
| 6202M | 1570 | 1750 | 1812 | 1931 | 2112 | 2251 | 2432 |

Dimensions (inches)
seat H 18.0 seat W 21.0 arm H 25.0
total H 33.75 total W 46.5 depth 25.0

For KYDEX® flat arms add suffix K and \$274
Exceeds BIFMA Seating Durability Test to 750 lbs per two seater
CAL 133, add \$240 List per two seater



6202M
66 lbs

Three Seater with outside arms

COM 5.25 yds
0.75 yd COM per single seat
1.0 yd COM per single back

| MODEL | COM | GR 1 | GR 2 | GR 3 | GR 4 | GR 5 | GR 6 |
|--------------|-------------|-------------|-------------|-------------|-------------|-------------|-------------|
| 6203M | 2052 | 2325 | 2414 | 2597 | 2864 | 3072 | 3346 |

Dimensions (inches)
seat H 18.0 seat W 21.0 arm H 25.0
total H 33.75 total W 67.5 depth 25.0

For KYDEX® flat arms add suffix K and \$274
Exceeds BIFMA Seating Durability Test to 1000 lbs per three seater
CAL 133, add \$360 List per three seater



6203M
92 lbs



COOPER COLLECTION - BALA Lounge Seating

Designed for today's healthcare facilities
Two and Three Seaters with half arms

Standard Features

- Separate seat and back
- Wood components in Beech, in any of 9 standard stains or stain-to-match at no upcharge
- Threaded replaceable glides
- Use in connected layouts at no upcharge
- Velcro removable back covers
- Replaceable seats
- Arms replaceable in the field
- Ships assembled
- Ships 1/carton 26 cu ft (2 seater), 1/carton 39 cu ft (3 seater)

Options

- Wood or polyurethane arms available in flat (WF or PF) or rounded (WR or PR) profile
- Round polyurethane arms available in Black, Sterling Grey and Taupe (RAL 7006)
- Flat polyurethane arms available in Black only
- KYDEX® flat arms available in Black (B) or Taupe RAL 7006 (T) or Sterling Grey (G)
- Connected and freestanding tables
- Antibacterial and antimicrobial fabrics available
- Different fabric on seat and back at no upcharge
- CAL 133

Contact Spec Customer Service to railroad fabrics (specify repeat info and yardage requirement will be provided) and for repeats greater than 5" x 5"



Two Seater with half arms

COM 3.5 yds
0.75 yd COM per single seat
1.0 yd COM per single back

| MODEL | COM | GR 1 | GR 2 | GR 3 | GR 4 | GR 5 | GR 6 |
|--------------|-------------|-------------|-------------|-------------|-------------|-------------|-------------|
| 6212M | 2013 | 2194 | 2257 | 2377 | 2558 | 2693 | 2878 |

Dimensions (inches)
seat H 18.0 seat W 21.0 arm H 25.0
total H 33.75 total W 48.0 depth 25.0

For KYDEX® flat arms add suffix K and \$411
Exceeds BIFMA Seating Durability Test to 750 lbs per two seater
CAL 133, add \$240 List per two seater



6212M
68 lbs

Three Seater with half arms

COM 5.25 yds
0.75 yd COM per single seat
1.0 yd COM per single back

| MODEL | COM | GR 1 | GR 2 | GR 3 | GR 4 | GR 5 | GR 6 |
|--------------|-------------|-------------|-------------|-------------|-------------|-------------|-------------|
| 6213M | 2940 | 3214 | 3304 | 3484 | 3755 | 3961 | 4233 |

Dimensions (inches)
seat H 18.0 seat W 21.0 arm H 25.0
total H 33.75 total W 70.5 depth 25.0

For KYDEX® flat arms add suffix K and \$548
Exceeds BIFMA Seating Durability Test to 1000 lbs per three seater
CAL 133, add \$360 List per three seater



6213M
96 lbs

COOPER COLLECTION - BALA Lounge Seating

Designed for today's healthcare facilities
Two and Three Seaters with full arms

Standard Features

- Separate seat and back
- Wood components in Beech, in any of 9 standard stains or stain-to-match at no upcharge
- Threaded replaceable glides
- Use in connected layouts at no upcharge
- Velcro removable back covers
- Replaceable seats
- Arms replaceable in the field
- Ships assembled
- Ships 1/carton 26 cu ft (2 seater), 1/carton 39 cu ft (3 seater)

Options

- Wood or polyurethane arms available in flat (WF or PF) or rounded (WR or PR) profile
- Round polyurethane arms available in Black, Sterling Grey and Taupe (RAL 7006)
- Flat polyurethane arms available in Black only
- KYDEX® flat arms available in Black (B) or Taupe RAL 7006 (T) or Sterling Grey (G)
- Connected and freestanding tables
- Antibacterial and antimicrobial fabrics available
- Different fabric on seat and back at no upcharge
- CAL 133

Contact Spec Customer Service to railroad fabrics (specify repeat info and yardage requirement will be provided) and for repeats greater than 5" x 5"

Two Seater with full arms

COM 3.5 yds
0.75 yd COM per single seat
1.0 yd COM per single back

| MODEL | COM | GR 1 | GR 2 | GR 3 | GR 4 | GR 5 | GR 6 |
|--------------|-------------|-------------|-------------|-------------|-------------|-------------|-------------|
| 6222M | 2013 | 2194 | 2257 | 2377 | 2558 | 2693 | 2878 |

Dimensions (inches)

| | seat H | 18.0 | seat W | 21.0 | arm H | 25.0 |
|---------|--------|---------|--------|-------|-------|------|
| total H | 33.75 | total W | 48.0 | depth | 25.0 | |

For KYDEX® flat arms add suffix K and \$411
Exceeds BIFMA Seating Durability Test to 750 lbs per two seater
CAL 133, add \$240 List per two seater



6222M
73 lbs

Three Seater with full arms

COM 5.25 yds
0.75 yd COM per single seat
1.0 yd COM per single back

| MODEL | COM | GR 1 | GR 2 | GR 3 | GR 4 | GR 5 | GR 6 |
|--------------|-------------|-------------|-------------|-------------|-------------|-------------|-------------|
| 6223M | 2940 | 3214 | 3304 | 3484 | 3755 | 3961 | 4233 |

Dimensions (inches)

| | seat H | 18.0 | seat W | 21.0 | arm H | 25.0 |
|---------|--------|---------|--------|-------|-------|------|
| total H | 33.75 | total W | 70.5 | depth | 25.0 | |

For KYDEX® flat arms add suffix K and \$548
Exceeds BIFMA Seating Durability Test to 1000 lbs per three seater
CAL 133, add \$360 List per three seater



6223M
99 lbs



COOPER COLLECTION - BALA Lounge Seating

Designed for today's healthcare facilities

Loveseat with arms

Standard Features

- Separate seat and back
- Wood components in Beech, in any of 9 standard stains or stain-to-match at no upcharge
- Threaded replaceable glides
- Use in connected layouts at no upcharge
- Velcro removable back covers
- Replaceable seats
- Arms replaceable in the field
- Ships assembled
- Ships 1/carton 20 cu ft

Options

- Wood or polyurethane arms available in flat (WF or PF) or rounded (WR or PR) profile
- Round polyurethane arms available in Black, Sterling Grey and Taupe (RAL 7006)
- Flat polyurethane arms available in Black only
- KYDEX® flat arms available in Black (B) or Taupe RAL 7006 (T) or Sterling Grey (G)
- Connected and freestanding tables
- Antibacterial and antimicrobial fabrics available
- Different fabric on seat and back at no upcharge
- CAL 133

Contact Spec Customer Service to railroad fabrics (specify repeat info and yardage requirement will be provided) and for repeats greater than 5" x 5"



Loveseat with arms

COM 4.0 yds
2.0 yd COM per single seat
2.0 yd COM per single back

| MODEL | COM | GR 1 | GR 2 | GR 3 | GR 4 | GR 5 | GR 6 |
|--------------|-------------|-------------|-------------|-------------|-------------|-------------|-------------|
| 6201L | 1700 | 1909 | 1979 | 2123 | 2330 | 2493 | 2706 |

Dimensions (inches)

| | | | | | |
|---------|-------|---------|-------|-------|------|
| seat H | 18.0 | seat W | 42.0 | arm H | 25.0 |
| total H | 33.75 | total W | 44.75 | depth | 25.0 |

For KYDEX® flat arms add suffix K and \$274
Exceeds BIFMA Seating Durability Test to 750 lbs per chair
CAL 133, add \$184 List per chair



6201L
66 lbs



COOPER COLLECTION - BALA Lounge Seating

Designed for today's healthcare facilities
Bariatric Single Seater with arms

Standard Features

- Separate seat and back
- Wood components in Beech, in any of 9 standard stains or stain-to-match at no upcharge
- Threaded replaceable glides
- Use in connected layouts at no upcharge
- Velcro removable back covers
- Replaceable seats
- Arms replaceable in the field
- Ships assembled
- Ships 1/carton 20 cu ft

Options

- Wood or polyurethane arms available in flat (WF or PF) or rounded (WR or PR) profile
- Round polyurethane arms available in Black, Sterling Grey and Taupe (RAL 7006)
- Flat polyurethane arms available in Black only
- KYDEX® flat arms available in Black (B) or Taupe RAL 7006 (T) or Sterling Grey (G)
- Connected and freestanding tables
- Antibacterial and antimicrobial fabrics available
- Different fabric on seat and back at no upcharge
- CAL 133

Contact Spec Customer Service to railroad fabrics (specify repeat info and yardage requirement will be provided) and for repeats greater than 5" x 5"



Bariatric Single Seater with arms

COM 3.0 yds
1.5 yd COM per single seat
1.5 yd COM per single back

| MODEL | COM | GR 1 | GR 2 | GR 3 | GR 4 | GR 5 | GR 6 |
|--------------|-------------|-------------|-------------|-------------|-------------|-------------|-------------|
| 6201G | 1296 | 1477 | 1537 | 1657 | 1838 | 1975 | 2155 |

Dimensions (inches)

| | | | | | |
|---------|-------|---------|-------|-------|------|
| seat H | 18.0 | seat W | 30.0 | arm H | 25.0 |
| total H | 33.75 | total W | 34.25 | depth | 25.0 |

For KYDEX® flat arms add suffix K and \$274
Exceeds BIFMA Seating Durability Test to 750 lbs per chair
CAL 133, add \$150 List per chair



6201G
47 lbs



COOPER COLLECTION - BALA Lounge Seating

Designed for today's healthcare facilities
 Highback Single Seater with arms – Ottoman

Standard Features

- Separate seat and back
- Wood components in Beech, in any of 9 standard stains or stain-to-match at no upcharge
- Threaded replaceable glides
- Use in connected layouts at no upcharge
- Velcro removable back covers
- Replaceable seats
- Arms replaceable in the field
- Ships assembled
- Ships 1/carton 19 cu ft
- Ottoman ships 1/carton 5 cu ft

Options

- Wood or polyurethane arms available in flat (WF or PF) or rounded (WR or PR) profile
- Round polyurethane arms available in Black, Sterling Grey and Taupe (RAL 7006)
- Flat polyurethane arms available in Black only
- KYDEX® flat arms available in Black (B) or Taupe RAL 7006 (T) or Sterling Grey (G)
- Vinyl insert on top of the back, add \$44 List/seat back
- Connected and freestanding tables
- Antibacterial and antimicrobial fabrics available
- Different fabric on seat and back at no upcharge
- CAL 133

Contact Spec Customer Service to railroad fabrics (specify repeat info and yardage requirement will be provided) and for repeats greater than 5" x 5"



Highback Single Seater with arms

COM 2.5 yds
 0.75 yd COM per single seat
 1.75 yds COM per single back

| MODEL | COM | GR 1 | GR 2 | GR 3 | GR 4 | GR 5 | GR 6 |
|--------------|-------------|-------------|-------------|-------------|-------------|-------------|-------------|
| 6201H | 1166 | 1306 | 1354 | 1451 | 1591 | 1700 | 1879 |

Dimensions (inches)

| | seat H | 18.0 | seat W | 21.0 | arm H | 25.0 |
|---------|--------|---------|--------|-------|-------|------|
| total H | 47.5 | total W | 25.25 | depth | 25.0 | |

For KYDEX® flat arms add suffix K and \$274
 Exceeds BIFMA Seating Durability Test to 500 lbs per chair
 CAL 133, add \$134 List per chair



6201H
43 lbs

Ottoman

0.5 yd COM per ottoman

| MODEL | COM | GR 1 | GR 2 | GR 3 | GR 4 | GR 5 | GR 6 |
|--------------|------------|------------|------------|------------|------------|------------|------------|
| 6230F | 494 | 527 | 541 | 563 | 601 | 626 | 675 |

Ottoman Dimensions (inches)

| H | 11.5 | W | 19.25 | depth | 12.25 |
|---|------|---|-------|-------|-------|
|---|------|---|-------|-------|-------|

CAL 133, add \$55 List



6230F
16 lbs



COOPER COLLECTION - BALA Lounge Seating

Designed for today's healthcare facilities
Half and Full Panel Arms

Options

- Antibacterial and antimicrobial fabrics available
- CAL 133

To order half panel arms, add Z to model number, e.g. 6201**Z**

To order full panel arms, add ZC to model number, e.g. 6201**ZC**

Pricing is for one half panel arm, e.g. for a single seater chair with half panel arms, add two half panel arms to cost of chair

Contact Spec Customer Service to railroad fabrics (specify repeat info and yardage requirement will be provided) and for repeats greater than 5" x 5"



Half and Full Panel Arms

COM 0.5 yds per half panel arm

| MODEL | COM | GR 1 | GR 2 | GR 3 | GR 4 | GR 5 | GR 6 |
|----------|-----------|------------|------------|------------|------------|------------|------------|
| Z | 77 | 102 | 108 | 124 | 149 | 166 | 193 |

COM 0.75 yds per full panel arm

| MODEL | COM | GR 1 | GR 2 | GR 3 | GR 4 | GR 5 | GR 6 |
|-----------|------------|------------|------------|------------|------------|------------|------------|
| ZC | 147 | 191 | 207 | 236 | 282 | 318 | 348 |

CAL 133, add \$42 List per half panel arm / \$80 List per full panel arm



1.5 lbs per half panel arm



3 lbs per full panel arm



COOPER COLLECTION - BALA Lounge Seating

Designed for today's healthcare facilities
Easy Access Hip Single Seater with arms

Standard Features

- Separate seat and back
- Wood components in Beech, in any of 9 standard stains or stain-to-match at no upcharge
- Threaded replaceable glides
- 24" seat height, no seat pitch (level)
- Footrest which assists entering/exiting chair
- Velcro replaceable back covers
- Replaceable seats
- Arms replaceable in the field
- Ships assembled
- Ships 1/carton 19 cu ft

Options

- Wood or polyurethane arms available in flat (WF or PF) or rounded (WR or PR) profile
- Round polyurethane arms available in Black, Sterling Grey and Taupe (RAL 7006)
- Flat polyurethane arms available in Black only
- KYDEX® flat arms available in Black (B) or Taupe RAL 7006 (T) or Sterling Grey (G)
- Antibacterial and antimicrobial fabrics available
- Different fabric on seat and back at no upcharge
- CAL 133

Contact Spec Customer Service to railroad fabrics (specify repeat info and yardage requirement will be provided) and for repeats greater than 5" x 5"



Easy Access Hip Single Seater with arms

COM 1.75 yds
0.75 yd COM per single seat
1.0 yd COM per single back

| MODEL | COM | GR 1 | GR 2 | GR 3 | GR 4 | GR 5 | GR 6 |
|---------------|-------------|-------------|-------------|-------------|-------------|-------------|-------------|
| 6201ME | 1314 | 1404 | 1433 | 1493 | 1584 | 1652 | 1744 |

Dimensions (inches)

| | | | | | |
|---------|------|---------|-------|-------|------|
| seat H | 24.0 | seat W | 21.0 | arm H | 32.0 |
| total H | 46.0 | total W | 25.25 | depth | 25.0 |

For KYDEX® flat arms add suffix K and \$274
Exceeds BIFMA Seating Durability Test to 500 lbs per chair
CAL 133, add \$120 List per chair



6201ME
45 lbs



COOPER COLLECTION - BALA Lounge Seating

Designed for today's healthcare facilities
Single and Two Seater Benches

Standard Features

- Wood components in Beech, in any of 9 standard stains or stain-to-match at no upcharge
- Threaded replaceable glides
- Use in connected layouts at no upcharge
- Velcro removable back covers
- Replaceable seats
- Arms replaceable in the field
- Ships assembled
- Ships 1/carton 9 cu ft (single seater), 14 cu ft (2 seater), 21 cu ft (3 seater)

Options

- Antibacterial and antimicrobial fabrics available
- CAL 133

Contact Spec Customer Service to railroad fabrics (specify repeat info and yardage requirement will be provided) and for repeats greater than 5" x 5"

Single Seater Bench

COM 1.0 yds
1.0 yd COM per single seat

| MODEL | COM | GR 1 | GR 2 | GR 3 | GR 4 | GR 5 | GR 6 |
|--------------|------------|------------|------------|------------|-------------|-------------|-------------|
| 6201B | 855 | 912 | 932 | 971 | 1032 | 1076 | 1159 |

No arms

| | | | | | | | |
|--------------|-------------|-------------|-------------|-------------|-------------|-------------|-------------|
| 6201B | 1093 | 1152 | 1172 | 1212 | 1270 | 1318 | 1404 |
|--------------|-------------|-------------|-------------|-------------|-------------|-------------|-------------|

End arms (WF/WR or PF/PR)

Dimensions (inches)

| | | | | | | | |
|---------|------|----------|-------|------------|-------|-------|-------|
| seat H | 18.0 | seat W | 21.0 | arm H | 24.0 | depth | 26.25 |
| total H | N/A | total W | 24.25 | total W | 25.25 | | |
| | | w/o arms | | w/end arms | | | |

Exceeds BIFMA Seating Durability Test to 500 lbs per bench
CAL 133, add \$55 List per bench



6201B
25 lbs

Two Seater Bench

COM 2.0 yds
1.0 yd COM per single seat

| MODEL | COM | GR 1 | GR 2 | GR 3 | GR 4 | GR 5 | GR 6 |
|--------------|-------------|-------------|-------------|-------------|-------------|-------------|-------------|
| 6202B | 1111 | 1229 | 1267 | 1348 | 1466 | 1555 | 1709 |

No arms

| | | | | | | | |
|--------------|-------------|-------------|-------------|-------------|-------------|-------------|-------------|
| 6202B | 1351 | 1468 | 1509 | 1586 | 1706 | 1795 | 1953 |
|--------------|-------------|-------------|-------------|-------------|-------------|-------------|-------------|

End arms (WF/WR or PF/PR)

| | | | | | | | |
|--------------|-------------|-------------|-------------|-------------|-------------|-------------|-------------|
| 6212B | 1695 | 1815 | 1854 | 1932 | 2051 | 2140 | 2307 |
|--------------|-------------|-------------|-------------|-------------|-------------|-------------|-------------|

Arms between and at ends (WF/WR or PF/PR)

Dimensions (inches)

| | | | | | | | |
|---------|------|----------|-------|------------|-------|----------------------------|-------|
| seat H | 18.0 | seat W | 21.0 | arm H | 24.0 | depth | 26.25 |
| total H | N/A | total W | 45.25 | total W | 46.25 | total W | 47.75 |
| | | w/o arms | | w/end arms | | w/arms between and at ends | |

Exceeds BIFMA Seating Durability Test to 750 lbs per two seat bench
CAL 133, add \$110 List per two seat bench



6202B
41 lbs



COOPER COLLECTION - BALA Lounge Seating

Designed for today's healthcare facilities

Three Seater Bench

Standard Features

- Wood components in Beech, in any of 9 standard stains or stain-to-match at no upcharge
- Use in connected layouts at no upcharge
- Threaded replaceable glides
- Velcro removable back covers
- Replaceable seats
- Arms replaceable in the field
- Ships assembled
- Ships 1/carton 9 cu ft (single seater), 14 cu ft (2 seater), 21 cu ft (3 seater)

Options

- Antibacterial and antimicrobial fabrics available
- CAL 133

Contact Spec Customer Service to railroad fabrics (specify repeat info and yardage requirement will be provided) and for repeats greater than 5" x 5"



Three Seater Bench

COM 3.0 yds
1.0 yd COM per single seat

| MODEL | COM | GR 1 | GR 2 | GR 3 | GR 4 | GR 5 | GR 6 |
|--|-------------|-------------|-------------|-------------|-------------|-------------|-------------|
| 6203B | 1432 | 1609 | 1669 | 1787 | 1965 | 2100 | 2325 |
| <i>No arms</i> | | | | | | | |
| 6203B | 1669 | 1846 | 1905 | 2025 | 2203 | 2335 | 2566 |
| <i>End arms (WF/WR or PF/PR)</i> | | | | | | | |
| 6213B | 2422 | 2601 | 2659 | 2777 | 2954 | 3090 | 3334 |
| <i>Arms between and at ends (WF/WR or PF/PR)</i> | | | | | | | |

Dimensions (inches)

| | | | | | | | |
|---------|------|----------|-------|------------|-------|----------------------------|-------|
| seat H | 18.0 | seat W | 21.0 | arm H | 24.0 | depth | 26.25 |
| total H | N/A | total W | 66.25 | total W | 67.25 | total W | 70.50 |
| | | w/o arms | | w/end arms | | w/arms between and at ends | |

Exceeds BIFMA Seating Durability Test to 1000 lbs per three seat bench
CAL 133, add \$165 List per three seat bench



6203B
56 lbs





COOPER COLLECTION - BALA Lounge Seating

Designed for today's healthcare facilities
Bariatric Single and Two Seater Benches

Standard Features

- Wood components in Beech, in any of 9 standard stains or stain-to-match at no upcharge
- Bariatric seating cannot connect to bariatric seating
- Threaded replaceable glides
- Use in connected layouts at no upcharge
- Velcro removable back covers
- Replaceable seats
- Arms replaceable in the field
- Ships assembled
- Ships 1/carton 15 cu ft (single seater), 20 cu ft (2 seater)

Options

- Wood or polyurethane arms, in flat (WF or PF) or rounded (WR or PR) profile, 6" in height, at ends of bench and between seats
- Round polyurethane arms available in Black, Sterling Grey and Taupe (RAL 7006)
- Flat polyurethane arms available in Black only
- KYDEX® flat arms available in Black (B) or Taupe RAL 7006 (T) or Sterling Grey (G)
- Antibacterial and antimicrobial fabrics available
- CAL 133

Contact Spec Customer Service to railroad fabrics (specify repeat info and yardage requirement will be provided) and for repeats greater than 5" x 5"



Bariatric Single Seater Bench

COM 1.5 yds
1.5 yd COM per single seat

| MODEL | COM | GR 1 | GR 2 | GR 3 | GR 4 | GR 5 | GR 6 |
|---------------|-------------|-------------|-------------|-------------|-------------|-------------|-------------|
| 6201BG | 1259 | 1325 | 1349 | 1394 | 1462 | 1514 | 1614 |

End arms (WF/WR or PF/PR)

Dimensions (inches)

| | seat H | 18.0 | seat W | 30.0 | arm H | 24.0 | depth | 26.25 |
|---------|--------|---------|--------|------|-------|------|-------|-------|
| total H | 24.0 | total W | 34.25 | | | | | |

For KYDEX® flat arms add suffix K and \$274
Exceeds BIFMA Seating Durability Test to 750 lbs per bench
CAL 133, add \$76 List per bench



6201BG
35 lbs

Bariatric Two Seater Bench

COM 3.0 yds
1.5 yd COM per single seat

| MODEL | COM | GR 1 | GR 2 | GR 3 | GR 4 | GR 5 | GR 6 |
|---------------|-------------|-------------|-------------|-------------|-------------|-------------|-------------|
| 6222BG | 1952 | 2086 | 2132 | 2224 | 2359 | 2463 | 2654 |

Arms between and at ends (WF/WR or PF/PR)

Dimensions (inches)

| | seat H | 18.0 | seat W | 30.0 | arm H | 24.0 | depth | 26.25 |
|---------|--------|---------|--------|------|-------|------|-------|-------|
| total H | 24.0 | total W | 66.0 | | | | | |

For KYDEX® flat arms add suffix K and \$411
Exceeds BIFMA Seating Durability Test to 1000 lbs per two seat bench
CAL 133, add \$152 List per two seat bench



6222BG
50 lbs

COOPER COLLECTION - BALA Lounge Seating

Designed for today's healthcare facilities

Freestanding Lounge Tables – Corner and Spacer Connecting Tables

Standard Features

- Tops in laminate or veneer
- Select laminate tops from 15 standard laminates or choose any standard Wilsonart, Nevamar, Formica, Arborite and Pionite matte finish laminates at no upcharge.
- Freestanding lounge tables available with PVC Flat (PVF), 2mm (2MM), exposed Baltic Birch plywood (PF, PKNR) or hardwood (HB) edge
- Connecting table tops available with PVC Flat (PVF) edge, Self edge (SE) or hardwood (HB) edge
- 9 standard veneer and hardwood edge stains. Stain-to-match available at no upcharge.
- Beech legs and Beech table skirts stained the same
- Tops utilize NU Green earth friendly core
- Threaded replaceable glides
- 18" height

Options

- Non-standard laminates, contact Spec for pricing
- Custom size spacer tables for restricted spaces
- Other sizes may be available

Radius Corner Tables are recommended for open areas

Freestanding Lounge Tables

| Model | Laminate PVF/SE/2MM | Laminate PF/PKNR/HB | Veneer HB | Weight | Cu.Ft. |
|-----------------|------------------------|------------------------|--------------|--------|--------|
| 62 - 24 x 24 SQ | 813 | 1008 | 1163 | 47 | 7.2 |
| 62 - 24 x 48 RE | 974 | 1189 | 1406 | 64 | 18 |
| 62 - 30 x 30 SQ | 920 | 1062 | 1227 | 57 | 13.5 |
| 62 - 22 DIA | 968 | 1328 | 1533 | 47 | 7.2 |



Corner and Spacer Connecting Tables

| Model | Laminate PVF/SE | Laminate HB Edge | Veneer HB Edge | Weight | Cu.Ft. |
|--|--------------------|---------------------|-------------------|--------|--------|
| 62RC - 28 x 28 <i>Radius Corner Table</i> | 832 | 1116 | 1308 | 42 | 2 |
| 62SC - 28 x 28 <i>Square Corner Table</i> | 909 | 1104 | 1218 | 46 | 2 |
| 62TC - 45 degree <i>Corner Table</i> | 832 | 1116 | 1308 | 40 | 2 |
| 62ST - 21 x 24 <i>Spacer Table</i> | 565 | 797 | 913 | 27 | 2 |
| 62ET - 21 x 24 <i>End Table</i> | 754 | 986 | 1103 | 37 | 2 |

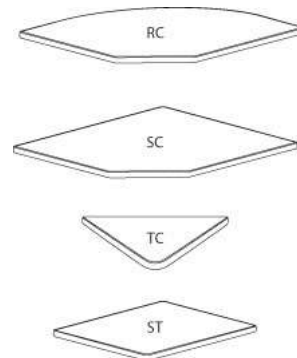

COOPER COLLECTION - DWIGHT Lounge Seating

LAYOUTS



Description

- Spec's Dwight offers a steel leg frame with elements of wood giving it a softer look and feel of wood, without sacrificing high durability.
- Your layout possibilities are unlimited with spacer, radius and corner tables – for both standard and bariatric seating in virtually any combination.
- Bariatric seating is a 30" wide seat and is load tested to 750 lbs. Cannot be connected to other bariatric seats.
- 21" seat width is standard.
- Standard in European Beech in any of 9 standard stains or stain-to-match at no upcharge.
- Choice of wood or polyurethane arms in flat (WF or PF) or rounded (WR or PR) profile.
- Arms are replaceable in the field.
- All models offer a choice of no center arms, half arms or full arms to the floor.
- Glides and separate seat and back are standard.
- Please send a drawing of the configuration you require with your order.
- For fabrics you wish railroaded or repeats larger than 5" x 5", please contact the factory with repeat information and yardage requirement will be provided.



LAYOUTS AND DIMENSIONS

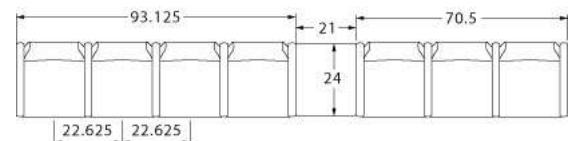
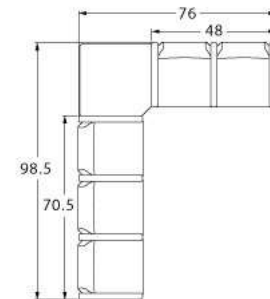
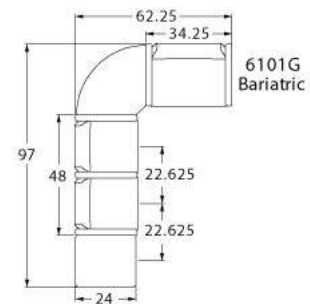

COOPER COLLECTION - DWIGHT Lounge Seating



PRODUCT CODE

6 1 2 3 M - WR

Collection

6 : Cooper

Series

1 : Dwight

Center Arm

- 0 : Outside Arms
- 1 : Half Arms
- 2 : Full Arms

Number of Seats

- 1 : Single Seater
- 2 : Two Seater
- 3 : Three Seater

Chair Type

- M : Mid Back
- H : Highback
- L : Loveseat
- G : Bariatric
- ME : Hip Chair
- B : Bench

Arm Type

- WF : Wood Flat Profile
- WR : Wood Round Profile
- PF : Poly Flat Profile
- G : Bariatric
- ME : Hip Chair
- K : KYDEX® Flat Profile



OPTIONS

ARM TYPE



Polyurethane



Wood



KYDEX®

PANEL ARMS



Half Panel Arms

FINISHES

FRAME



Select from one of our 76 standard Spectone colors

FABRIC



Select fabrics from one of our textile partners

ARMS



Black

Sterling Grey

Taupe

Select from one of our 9 standard wood stains or stain-to-match at no upcharge

See Spectone Card or specfurniture.com/materials/finishes for a complete list of finish options and colors.



COOPER COLLECTION - DWIGHT Lounge Seating

HOW TO ORDER

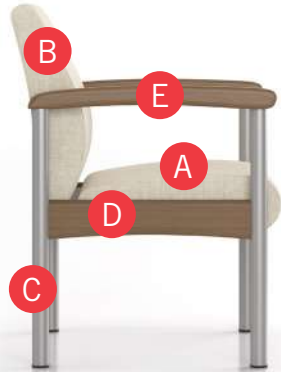

Specify Model

- A** Specify Fabric - Seat¹
Manufacturer, Pattern Name, Color
- B** Specify Fabric - Back¹
Manufacturer, Pattern Name, Color
- C** Specify Frame Finish
- D** Specify Side Rail Finish
- E** Specify Arm Type, Profile and Color
Polyurethane (Flat or Round) / Wood (Flat or Round) / KYDEX® (\$) (Flat)

Optional: KYDEX® Arm, CAL 133, Moisture Barrier, Half Panel Arms, Connecting and Freestanding Tables, Benches, Ottoman, Vinyl Headrest Insert

¹ When multiple fabrics are specified on two and three seat chairs, please provide a drawing and legend for fabric placement.

| Model | Fabric - Seat | Fabric - Back | Frame Finish | Side Rail Finish | Arm Type, Profile and Color |
|-------|---------------------------|---------------------------|--------------|-------------------|--------------------------------|
| 6101M | Momentum, Beeline, Canvas | Momentum, Beeline, Canvas | Silver | Studio Teak Stain | Wood, Round, Studio Teak Stain |





COOPER COLLECTION - DWIGHT Lounge Seating

Designed for today's healthcare facilities
Single Seater with arms

Standard Features

- Separate seat and back
- Wood components in Beech, in any of 9 standard stains or stain-to-match at no upcharge
- Fully welded frame with 1.625" steel legs
- Frame in any Spectone color
- Glides
- Velcro removable back covers
- Replaceable seats
- Arms replaceable in the field
- Use in connected layouts at no upcharge
- Ships assembled
- Ships 1/carton 15 cu ft

Options

- Wood or polyurethane arms, in flat (WF or PF) or rounded (WR or PR) profile
- Round polyurethane arms available in Black, Sterling Grey and Taupe (RAL 7006)
- Flat polyurethane arms available in Black only
- KYDEX® flat arms available in Black (B) or Taupe RAL 7006 (T) or Sterling Grey (G)
- Connected and freestanding tables
- Antibacterial and antimicrobial fabrics available
- Different fabric on seat and back at no upcharge
- CAL 133

Contact Spec Customer Service to railroad fabrics (specify repeat info and yardage requirement will be provided) and for repeats greater than 5" x 5"



Single Seater with arms

COM 1.75 yds
0.75 yd COM per single seat
1.0 yd COM per single back

| MODEL | COM | GR 1 | GR 2 | GR 3 | GR 4 | GR 5 | GR 6 |
|--------------|-------------|-------------|-------------|-------------|-------------|-------------|-------------|
| 6101M | 1067 | 1156 | 1186 | 1247 | 1336 | 1406 | 1497 |

Dimensions (inches)

| | | | | | |
|---------|-------|---------|-------|-------|------|
| seat H | 18.0 | seat W | 21.0 | arm H | 25.0 |
| total H | 33.75 | total W | 25.25 | depth | 25.0 |

For KYDEX® flat arms add suffix K and \$274
Dynamic load tested to 500 lbs per chair
CAL 133, add \$120 List per chair



6101M
40 lbs



COOPER COLLECTION - DWIGHT Lounge Seating

Designed for today's healthcare facilities
Two and Three Seaters with outside arms

Standard Features

- Separate seat and back
- Wood components in Beech, in any of 9 standard stains or stain-to-match at no upcharge
- Fully welded frame with 1.625" steel legs
- Frame in any Spectone color
- Glides
- Velcro removable back covers
- Replaceable seats
- Arms removable in the field
- Use in connected layouts at no upcharge
- Ships assembled
- Ships 1/carton 26 cu ft (2 seater), 1/carton 39 cu ft (3 seater)

Options

- Wood or polyurethane arms, in flat (WF or PF) or rounded (WR or PR) profile
- Round polyurethane arms available in Black, Sterling Grey and Taupe (RAL 7006)
- Flat polyurethane arms available in Black only
- KYDEX® flat arms available in Black (B) or Taupe RAL 7006 (T) or Sterling Grey (G)
- Connected and freestanding tables
- Antibacterial and antimicrobial fabrics available
- Different fabric on seat and back at no upcharge
- CAL 133

Contact Spec Customer Service to railroad fabrics (specify repeat info and yardage requirement will be provided) and for repeats greater than 5" x 5"



Two Seater with outside arms

COM 3.5 yds
0.75 yd COM per single seat
1.0 yd COM per single back

| MODEL | COM | GR 1 | GR 2 | GR 3 | GR 4 | GR 5 | GR 6 |
|--------------|-------------|-------------|-------------|-------------|-------------|-------------|-------------|
| 6102M | 1546 | 1727 | 1788 | 1908 | 2090 | 2228 | 2407 |

Dimensions (inches)

| seat H | 18.0 | seat W | 21.0 | arm H | 25.0 |
|---------|-------|---------|------|-------|------|
| total H | 33.75 | total W | 46.5 | depth | 25.0 |

For KYDEX® flat arms add suffix K and \$274
Dynamic load tested to 750 lbs per two seater
CAL 133, add \$240 List per two seater



6102M
66 lbs

Three Seater with outside arms

COM 5.25 yds
0.75 yd COM per single seat
1.0 yd COM per single back

| MODEL | COM | GR 1 | GR 2 | GR 3 | GR 4 | GR 5 | GR 6 |
|--------------|-------------|-------------|-------------|-------------|-------------|-------------|-------------|
| 6103M | 2029 | 2302 | 2391 | 2571 | 2843 | 3050 | 3321 |

Dimensions (inches)

| seat H | 18.0 | seat W | 21.0 | arm H | 25.0 |
|---------|-------|---------|------|-------|------|
| total H | 33.75 | total W | 67.5 | depth | 25.0 |

For KYDEX® flat arms add suffix K and \$274
Dynamic load tested to 1000 lbs per three seater
CAL 133, add \$360 List per three seater



6103M
92 lbs



COOPER COLLECTION - DWIGHT Lounge Seating

Designed for today's healthcare facilities
Two and Three Seaters with half arms

Standard Features

- Separate seat and back
- Wood components in Beech, in any of 9 standard stains or stain-to-match at no upcharge
- Fully welded frame with 1.625" steel legs
- Frame in any Spectone color
- Glides
- Velcro removable back covers
- Replaceable seats
- Arms replaceable in the field
- Use in connected layouts at no upcharge
- Ships assembled
- Ships 1/carton 26 cu ft (2 seater), 1/carton 39 cu ft (3 seater)

Options

- Wood or polyurethane arms, in flat (WF or PF) or rounded (WR or PR) profile
- Round polyurethane arms available in Black, Sterling Grey and Taupe (RAL 7006)
- Flat polyurethane arms available in Black only
- KYDEX® flat arms available in Black (B) or Taupe RAL 7006 (T) or Sterling Grey (G)
- Connected and freestanding tables
- Antibacterial and antimicrobial fabrics available
- Different fabric on seat and back at no upcharge
- CAL 133

Contact Spec Customer Service to railroad fabrics (specify repeat info and yardage requirement will be provided) and for repeats greater than 5" x 5"



Two Seater with half arms

COM 3.5 yds
0.75 yd COM per single seat
1.0 yd COM per single back

| MODEL | COM | GR 1 | GR 2 | GR 3 | GR 4 | GR 5 | GR 6 |
|--------------|-------------|-------------|-------------|-------------|-------------|-------------|-------------|
| 6112M | 1972 | 2152 | 2214 | 2334 | 2513 | 2653 | 2833 |

Dimensions (inches)

| seat H | 18.0 | seat W | 21.0 | arm H | 25.0 |
|---------|-------|---------|------|-------|------|
| total H | 33.75 | total W | 48.0 | depth | 25.0 |

For KYDEX® flat arms add suffix K and \$411
Dynamic load tested to 750 lbs per two seater
CAL 133, add \$240 List per two seater



6112M
68 lbs

Three Seater with half arms

COM 5.25 yds
0.75 yd COM per single seat
1.0 yd COM per single back

| MODEL | COM | GR 1 | GR 2 | GR 3 | GR 4 | GR 5 | GR 6 |
|--------------|-------------|-------------|-------------|-------------|-------------|-------------|-------------|
| 6113M | 2880 | 3150 | 3240 | 3421 | 3693 | 3898 | 4170 |

Dimensions (inches)

| seat H | 18.0 | seat W | 21.0 | arm H | 25.0 |
|---------|-------|---------|------|-------|------|
| total H | 33.75 | total W | 70.5 | depth | 25.0 |

For KYDEX® flat arms add suffix K and \$548
Dynamic load tested to 1000 lbs per three seater
CAL 133, add \$360 List per three seater



6113M
96 lbs



COOPER COLLECTION - DWIGHT Lounge Seating

Designed for today's healthcare facilities

Two and Three Seaters with full arms

Standard Features

- Separate seat and back
- Wood components in Beech, in any of 9 standard stains or stain-to-match at no upcharge
- Fully welded frame with 1.625" steel legs
- Frame in any Spectone color
- Glides
- Velcro removable back covers
- Replaceable seats
- Arms replaceable in the field
- Use in connected layouts at no upcharge
- Ships assembled
- Ships 1/carton 26 cu ft (2 seater), 1/carton 39 cu ft (3 seater)

Options

- Wood or polyurethane arms, in flat (WF or PF) or rounded (WR or PR) profile
- Round polyurethane arms available in Black, Sterling Grey and Taupe (RAL 7006)
- Flat polyurethane arms available in Black only
- KYDEX® flat arms available in Black (B) or Taupe RAL 7006 (T) or Sterling Grey (G)
- Connected and freestanding tables
- Antibacterial and antimicrobial fabrics available
- Different fabric on seat and back at no upcharge
- CAL 133

Contact Spec Customer Service to railroad fabrics (specify repeat info and yardage requirement will be provided) and for repeats greater than 5" x 5"



Two Seater with full arms

COM 3.5 yds
0.75 yd COM per single seat
1.0 yd COM per single back

| MODEL | COM | GR 1 | GR 2 | GR 3 | GR 4 | GR 5 | GR 6 |
|--------------|-------------|-------------|-------------|-------------|-------------|-------------|-------------|
| 6122M | 1972 | 2152 | 2214 | 2334 | 2513 | 2653 | 2833 |

Dimensions (inches)

| seat H | 18.0 | seat W | 21.0 | arm H | 25.0 |
|---------|-------|---------|------|-------|------|
| total H | 33.75 | total W | 48.5 | depth | 25.0 |

For KYDEX® flat arms add suffix K and \$411
Dynamic load tested to 750 lbs per two seater
CAL 133, add \$240 List per two seater



6122M
73 lbs

Three Seater with full arms

COM 5.25 yds
0.75 yd COM per single seat
1.0 yd COM per single back

| MODEL | COM | GR 1 | GR 2 | GR 3 | GR 4 | GR 5 | GR 6 |
|--------------|-------------|-------------|-------------|-------------|-------------|-------------|-------------|
| 6123M | 2880 | 3150 | 3240 | 3421 | 3693 | 3898 | 4170 |

Dimensions (inches)

| seat H | 18.0 | seat W | 21.0 | arm H | 25.0 |
|---------|-------|---------|------|-------|------|
| total H | 33.75 | total W | 70.5 | depth | 25.0 |

For KYDEX® flat arms add suffix K and \$548
Dynamic load tested to 1000 lbs per three seater
CAL 133, add \$360 List per three seater



6123M
99 lbs



COOPER COLLECTION - DWIGHT Lounge Seating

Designed for today's healthcare facilities

Loveseat with arms

Standard Features

- Separate seat and back
- Wood components in Beech, in any of 9 standard stains or stain-to-match at no upcharge
- Fully welded frame with 1.625" steel legs
- Frame in any Spectone color
- Glides
- Velcro removable back covers
- Replaceable seats
- Arms replaceable in the field
- Use in connected layouts at no upcharge
- Ships assembled
- Ships 1/carton 20 cu ft

Options

- Wood or polyurethane arms, in flat (WF or PF) or rounded (WR or PR) profile
- Round polyurethane arms available in Black, Sterling Grey and Taupe (RAL 7006)
- Flat polyurethane arms available in Black only
- KYDEX® flat arms available in Black (B) or Taupe RAL 7006 (T) or Sterling Grey (G)
- Connected and freestanding tables
- Antibacterial and antimicrobial fabrics available
- Different fabric on seat and back at no upcharge
- CAL 133

Contact Spec Customer Service to railroad fabrics (specify repeat info and yardage requirement will be provided) and for repeats greater than 5" x 5"



Loveseat with arms

COM 4.0 yds
2.0 yd COM per single seat
2.0 yd COM per single back

| MODEL | COM | GR 1 | GR 2 | GR 3 | GR 4 | GR 5 | GR 6 |
|--------------|-------------|-------------|-------------|-------------|-------------|-------------|-------------|
| 6101L | 1672 | 1883 | 1952 | 2097 | 2304 | 2465 | 2677 |

Dimensions (inches)

| | | | | | |
|---------|-------|---------|-------|-------|------|
| seat H | 18.0 | seat W | 42.0 | arm H | 25.0 |
| total H | 33.75 | total W | 44.75 | depth | 25.0 |

For KYDEX® flat arms add suffix K and \$274

Dynamic Load Tested to 750 lbs per chair

CAL 133, add \$184 List per chair



6101L
66 lbs



COOPER COLLECTION - DWIGHT Lounge Seating

Designed for today's healthcare facilities
Bariatric Single Seater with arms

Standard Features

- Separate seat and back
- Wood components in Beech, in any of 9 standard stains or stain-to-match at no upcharge
- Fully welded frame with 1.625" steel legs
- Frame in any Spectone color
- Glides
- Velcro removable back covers
- Replaceable seats
- Arms replaceable in the field
- Use in connected layouts at no upcharge
- Bariatric seating cannot connect to bariatric seating
- Ships assembled
- Ships 1/carton 20 cu ft

Options

- Wood or polyurethane arms, in flat (WF or PF) or rounded (WR or PR) profile
- Round polyurethane arms available in Black, Sterling Grey and Taupe (RAL 7006)
- Flat polyurethane arms available in Black only
- KYDEX® flat arms available in Black (B) or Taupe RAL 7006 (T) or Sterling Grey (G)
- Connected and freestanding tables
- Antibacterial and antimicrobial fabrics available
- Different fabric on seat and back at no upcharge
- CAL 133

Contact Spec Customer Service to railroad fabrics (specify repeat info and yardage requirement will be provided) and for repeats greater than 5" x 5"



Bariatric Single Seater with arms

COM 3.0 yds
1.5 yd COM per single seat
1.5 yd COM per single back

| MODEL | COM | GR 1 | GR 2 | GR 3 | GR 4 | GR 5 | GR 6 |
|--------------|-------------|-------------|-------------|-------------|-------------|-------------|-------------|
| 6101G | 1272 | 1454 | 1514 | 1634 | 1815 | 1952 | 2134 |

Dimensions (inches)

| | | | | | |
|---------|-------|---------|-------|-------|------|
| seat H | 18.0 | seat W | 30.0 | arm H | 25.0 |
| total H | 33.75 | total W | 34.25 | depth | 25.0 |

For KYDEX® flat arms add suffix K and \$274

Dynamic Load Tested to 750 lbs per chair
CAL 133, add \$150 List per chair



6101G
47 lbs



COOPER COLLECTION - DWIGHT Lounge Seating

Designed for today's healthcare facilities
 Highback Single Seater with arms – Ottoman

Standard Features

- Separate seat and back
- Wood components in Beech, in any of 9 standard stains or stain-to-match at no upcharge
- Fully welded frame with 1.625" steel legs
- Frame in any Spectone color
- Glides
- Velcro removable back covers
- Replaceable seats
- Arms replaceable in the field
- Use in connected layouts at no upcharge
- Ships assembled
- Ships 1/carton 19 cu ft
- Ottoman ships 1/carton 5 cu ft

Options

- Wood or polyurethane arms, in flat (WF or PF) or rounded (WR or PR) profile
- Round polyurethane arms available in Black, Sterling Grey and Taupe (RAL 7006)
- Flat polyurethane arms available in Black only
- KYDEX® flat arms available in Black (B) or Taupe RAL 7006 (T) or Sterling Grey (G)
- Vinyl insert on top of the back, add \$44 List/seat back
- Connected and freestanding tables
- Antibacterial and antimicrobial fabrics available
- Different fabric on seat and back at no upcharge
- CAL 133

Contact Spec Customer Service to railroad fabrics (specify repeat info and yardage requirement will be provided) and for repeats greater than 5" x 5"



Highback Single Seater with arms

COM 2.5 yds
 0.75 yd COM per single seat
 1.75 yds COM per single back

| MODEL | COM | GR 1 | GR 2 | GR 3 | GR 4 | GR 5 | GR 6 |
|--------------|-------------|-------------|-------------|-------------|-------------|-------------|-------------|
| 6101H | 1141 | 1284 | 1328 | 1426 | 1567 | 1674 | 1854 |

Dimensions (inches)

| | seat H | 18.0 | seat W | 21.0 | arm H | 25.0 |
|---------|--------|---------|--------|-------|-------|------|
| total H | 47.5 | total W | 25.25 | depth | 25.0 | |

For KYDEX® flat arms add suffix K and \$274
 Dynamic load tested to 500 lbs per chair
 CAL 133, add \$134 List per chair



6101H
43 lbs

Ottoman

0.5 yd COM per ottoman

| MODEL | COM | GR 1 | GR 2 | GR 3 | GR 4 | GR 5 | GR 6 |
|--------------|------------|------------|------------|------------|------------|------------|------------|
| 6130F | 465 | 499 | 512 | 536 | 572 | 600 | 646 |

Ottoman Dimensions (inches)

| H | 11.5 | W | 19.25 | depth | 12.25 |
|---|------|---|-------|-------|-------|
|---|------|---|-------|-------|-------|

CAL 133, add \$55 List



6130F
16 lbs



COOPER COLLECTION - DWIGHT Lounge Seating

Designed for today's healthcare facilities

Half Panel Arm

Options

To order half panel arms, add Z to model number, e.g. 6101Z

- Antibacterial and antimicrobial fabrics available
- CAL 133

Pricing is for one half panel arm, e.g. for a single seater chair with half panel arms, add two half panel arms to cost of chair

Contact Spec Customer Service to railroad fabrics (specify repeat info and yardage requirement will be provided) and for repeats greater than 5" x 5"



Half Panel Arm

COM 0.5 yds per half panel arm

| MODEL | COM | GR 1 | GR 2 | GR 3 | GR 4 | GR 5 | GR 6 |
|----------|-----------|------------|------------|------------|------------|------------|------------|
| Z | 77 | 102 | 108 | 124 | 149 | 166 | 193 |

CAL 133, add \$42 List per half panel arm



1.5 lbs per half panel arm



COOPER COLLECTION - DWIGHT Lounge Seating

Designed for today's healthcare facilities
Easy Access Hip Single Seater with arms

Standard Features

- Separate seat and back
- Wood components in Beech, in any of 9 standard stains or stain-to-match at no upcharge
- Fully welded frame with 1.625" steel legs
- Frame in any Spectone color
- Glides
- Velcro removable back covers
- Replaceable seats
- Arms replaceable in the field
- 24" seat height, no seat pitch (level)
- Footrest which assists entering/exiting chair
- Ships assembled
- Ships 1/carton 19 cu ft

Options

- Wood or polyurethane arms, in flat (WF or PF) or rounded (WR or PR) profile
- Round polyurethane arms available in Black, Sterling Grey and Taupe (RAL 7006)
- Flat polyurethane arms available in Black only
- KYDEX® flat arms available in Black (B) or Taupe RAL 7006 (T) or Sterling Grey (G)
- Antibacterial and antimicrobial fabrics available
- Different fabric on seat and back at no upcharge
- CAL 133

Contact Spec Customer Service to railroad fabrics (specify repeat info and yardage requirement will be provided) and for repeats greater than 5" x 5"



Easy Access Hip Single Seater with arms

COM 1.75 yds
0.75 yd COM per single seat
1.0 yd COM per single back

| MODEL | COM | GR 1 | GR 2 | GR 3 | GR 4 | GR 5 | GR 6 |
|---------------|-------------|-------------|-------------|-------------|-------------|-------------|-------------|
| 6101ME | 1290 | 1381 | 1409 | 1471 | 1561 | 1630 | 1721 |

Dimensions (inches)

| | | | | | |
|---------|------|---------|-------|-------|------|
| seat H | 24.0 | seat W | 21.0 | arm H | 32.0 |
| total H | 46.0 | total W | 25.25 | depth | 25.0 |

For KYDEX® flat arms add suffix K and \$274

Dynamic Load Tested to 500 lbs per chair
CAL 133, add \$120 List per chair



6101ME
47 lbs



COOPER COLLECTION - DWIGHT Lounge Seating

Designed for today's healthcare facilities
Single and Two Seater Benches

Standard Features

- Wood components in Beech, in any of 9 standard stains or stain-to-match at no upcharge
- Fully welded frame with 1.625" steel legs
- Frame in any Spectone color
- Glides
- Use in connected layouts at no upcharge
- Arms replaceable in the field
- Replaceable seats
- Ships assembled
- Ships 1/carton 9 cu ft (single seater), 14 cu ft (2 seater), 21 cu ft (3 seater)

Options

- Antibacterial and antimicrobial fabrics available
- CAL 133

Contact Spec Customer Service to railroad fabrics (specify repeat info and yardage requirement will be provided) and for repeats greater than 5" x 5"

Single Seater Bench

COM 1.0 yds
1.0 yd COM per single seat

| MODEL | COM | GR 1 | GR 2 | GR 3 | GR 4 | GR 5 | GR 6 |
|----------------------------------|------------|------------|------------|-------------|-------------|-------------|-------------|
| 6101B | 656 | 716 | 735 | 776 | 834 | 879 | 958 |
| <i>No arms</i> | | | | | | | |
| 6101B | 894 | 955 | 971 | 1012 | 1071 | 1116 | 1201 |
| <i>End arms (WF/WR or PF/PR)</i> | | | | | | | |
| Dimensions (inches) | | | | | | | |
| seat H | 18.0 | seat W | 21.0 | arm H | 24.0 | depth | 26.25 |
| total H | N/A | total W | 24.25 | total W | 25.25 | | |
| | | w/o arms | | w/end arms | | | |



6101B
22 lbs

Dynamic load tested to 500 lbs per bench
CAL 133, add \$55 List per bench

Two Seater Bench

COM 2.0 yds
1.0 yd COM per single seat

| MODEL | COM | GR 1 | GR 2 | GR 3 | GR 4 | GR 5 | GR 6 |
|--|-------------|-------------|-------------|-------------|-------------|-------------|-------------|
| 6102B | 915 | 1032 | 1071 | 1150 | 1269 | 1359 | 1509 |
| <i>No arms</i> | | | | | | | |
| 6102B | 1151 | 1271 | 1311 | 1387 | 1508 | 1597 | 1750 |
| <i>End arms (WF/WR or PF/PR)</i> | | | | | | | |
| 6112B | 1374 | 1492 | 1533 | 1610 | 1728 | 1820 | 1979 |
| <i>Arms between and at ends (WF/WR or PF/PR)</i> | | | | | | | |
| Dimensions (inches) | | | | | | | |
| seat H | 18.0 | seat W | 21.0 | arm H | 24.0 | depth | 26.25 |
| total H | N/A | total W | 45.25 | total W | 46.25 | | |
| | | w/o arms | | w/end arms | | | |



6102B
41 lbs

Dynamic load tested to 750 lbs per two seat bench
CAL 133, add \$110 List per two seat bench



COOPER COLLECTION - DWIGHT Lounge Seating

Designed for today's healthcare facilities
Three Seater Bench

Standard Features

- Wood components in Beech, in any of 9 standard stains or stain-to-match at no upcharge
- Fully welded frame with 1.625" steel legs
- Frame in any Spectone color
- Glides
- Use in connected layouts at no upcharge
- Arms replaceable in the field
- Replaceable seats
- Ships assembled
- Ships 1/carton 9 cu ft (single seater), 14 cu ft (2 seater), 21 cu ft (3 seater)

Options

- Antibacterial and antimicrobial fabrics available
- CAL 133

Contact Spec Customer Service to railroad fabrics (specify repeat info and yardage requirement will be provided) and for repeats greater than 5" x 5"



Three Seater Bench

COM 3.0 yds
1.0 yd COM per single seat

| MODEL | COM | GR 1 | GR 2 | GR 3 | GR 4 | GR 5 | GR 6 |
|--|-------------|-------------|-------------|-------------|-------------|-------------|-------------|
| 6103B | 1232 | 1408 | 1467 | 1585 | 1763 | 1899 | 2117 |
| <i>No arms</i> | | | | | | | |
| 6103B | 1471 | 1648 | 1708 | 1825 | 2004 | 2137 | 2364 |
| <i>End arms (WF/WR or PF/PR)</i> | | | | | | | |
| 6113B | 1979 | 2156 | 2215 | 2334 | 2511 | 2647 | 2884 |
| <i>Arms between and at ends (WF/WR or PF/PR)</i> | | | | | | | |



6103B
60 lbs

Dimensions (inches)

| | | | | | | | |
|---------|------|----------|-------|------------|-------|-------|-------|
| seat H | 18.0 | seat W | 21.0 | arm H | 24.0 | depth | 26.25 |
| total H | N/A | total W | 66.25 | total W | 67.25 | | |
| | | w/o arms | | w/end arms | | | |

Dynamic load tested to 1000 lbs per three seat bench
CAL 133, add \$165 List per three seat bench



COOPER COLLECTION - DWIGHT Lounge Seating

Designed for today's healthcare facilities

Freestanding Lounge Tables – Corner and Spacer Connecting Tables

Standard Features

- Tops in laminate or veneer
- Select laminate tops from 15 standard laminates or choose any standard Wilsonart, Nevamar, Formica, Arborite and Pionite matte finish laminates at no upcharge.
- Freestanding lounge tables available with PVC Flat (PVF), 2mm (2MM), exposed Baltic Birch plywood (PF, PKNR) or hardwood (HB) edge
- Connecting table tops available with PVC Flat (PVF) edge, Self edge (SE) or hardwood (HB) edge
- 9 standard veneer and hardwood edge stains. Stain-to-match available at no upcharge.
- Steel legs and Beech table skirts
- Frame in any Spectone color
- Tops utilize NU Green earth friendly core
- Threaded replaceable glides
- 18" height

Options

- Non-standard laminates, contact Spec for pricing
- Custom size spacer tables for restricted spaces
- Self edge available at same cost as PVC Flat (PVF) edge
- Other sizes may be available

Radius Corner Tables are recommended for open areas

Freestanding Lounge Tables

| Model | Laminate PVF/SE/2MM | Laminate PF/PKNR/HB | Veneer HB | Weight | Cu.Ft. |
|-----------------|------------------------|------------------------|--------------|--------|--------|
| 61 - 24 x 24 SQ | 639 | 833 | 988 | 47 | 7.2 |
| 61 - 24 x 48 RE | 800 | 1014 | 1232 | 64 | 18 |
| 61 - 30 x 30 SQ | 746 | 887 | 1052 | 57 | 13.5 |
| 61 - 22 DIA | 799 | 1159 | 1363 | 47 | 7.2 |



Corner and Spacer Connecting Tables

| Model | Laminate PVF/SE | Laminate HB Edge | Veneer HB Edge | Weight | Cu.Ft. |
|--|--------------------|---------------------|-------------------|--------|--------|
| 61RC - 28 x 28 <i>Radius Corner Table</i> | 832 | 1116 | 1308 | 42 | 2 |
| 61SC - 28 x 28 <i>Square Corner Table</i> | 909 | 1104 | 1218 | 46 | 2 |
| 61TC - 45 degree <i>Corner Table</i> | 832 | 1116 | 1308 | 40 | 2 |
| 61ST - 21 x 24 <i>Spacer Table</i> | 565 | 797 | 913 | 27 | 2 |
| 61ET - 21 x 24 <i>End Table</i> | 754 | 986 | 1103 | 37 | 2 |

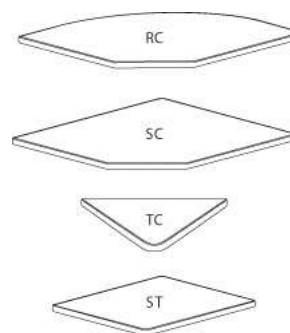

COOPER COLLECTION - HUNTSVILLE Lounge Seating

LAYOUTS



Description

- Spec's Huntsville offers the softer look and feel of wood, without sacrificing high durability.
- Your layout possibilities are unlimited with spacer, radius and corner tables – for both standard and bariatric seating in virtually any combination.
- Bariatric seating is a 30" wide seat and is load tested to 750 lbs. Cannot be connected to other bariatric seats.
- 21" seat width is standard.
- Standard in European Beech in any of 9 standard stains or stain-to-match at no upcharge.
- Choice of wood or polyurethane arms which are replaceable in the field.
- All models offer a choice of no center arms, half arms or full arms to the floor.
- Wall-saving frame is standard to protect both wall and fabric.
- Glides and separate seat and back are standard.
- Please send a drawing of the configuration you require with your order.
- For fabrics you wish railroaded or repeats larger than 5" x 5", please contact the factory with repeat information and yardage requirement will be provided.



LAYOUTS AND DIMENSIONS

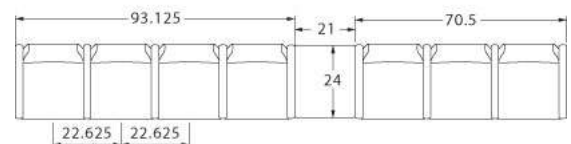
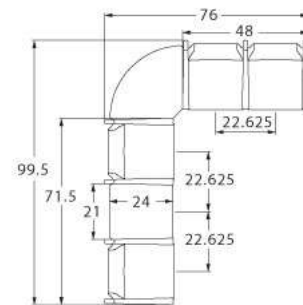
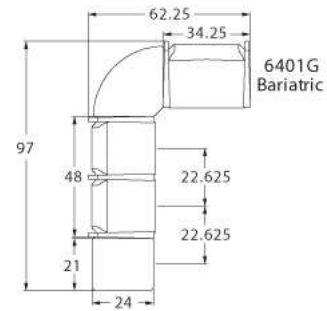



COOPER COLLECTION - HUNTSVILLE Lounge Seating



PRODUCT CODE

6 4 2 1 M

| | | | | |
|---------------------------------|---------------------------------|---|---|---|
| Collection 6 : Cooper | Series 4 : Huntsville | Center Arm 0 : Outside Arms 1 : Half Arms 2 : Full Arms | Number of Seats 1 : Single Seater 2 : Two Seater 3 : Three Seater | Chair Type M : Midback H : Highback L : Loveseat G : Bariatric |
|---------------------------------|---------------------------------|---|---|---|



OPTIONS

ARM TYPE



Polyurethane or Wood
**This image does not represent actual product arm.*

PANEL ARMS



Half Panel Arms

Full Panel Arms

FINISHES

FRAME

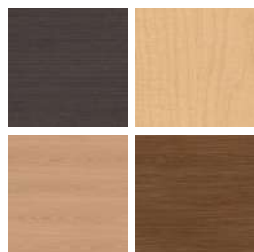

Select from one of our 9 standard wood stains or stain-to-match at no upcharge

FABRIC

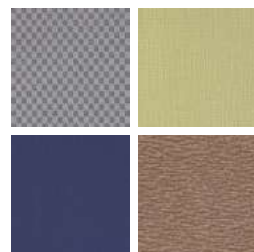

Select fabrics from one of our textile partners

ARMS



Black

Select from one of our 9 standard wood stains or stain-to-match at no upcharge

See Spectone Card or specfurniture.com/materials/finishes for a complete list of finish options and colors.



COOPER COLLECTION - HUNTSVILLE Lounge Seating

BACK TO CONTENTS

HOW TO ORDER

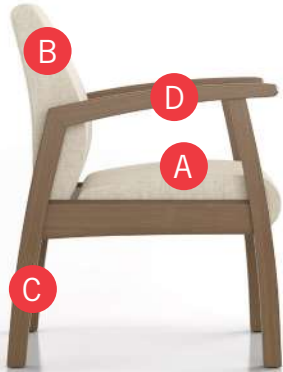

Specify Model

- A** Specify Fabric - Seat¹
Manufacturer, Pattern Name, Color
- B** Specify Fabric - Back¹
Manufacturer, Pattern Name, Color
- C** Specify Frame Finish
- D** Specify Arm Type and Color
Polyurethane / Wood

Optional: Polyurethane Arm, CAL 133, Moisture Barrier, Half or Full Panel Arms, Connecting and Freestanding Tables, Ottoman, Velcro Removable Headrest, Vinyl Headrest Insert

¹ When multiple fabrics are specified on two and three seat chairs, please provide a drawing and legend for fabric placement.



| Model | Fabric - Seat | Fabric - Back | Frame Finish | Arm Type and Color |
|-------|---------------------------|---------------------------|-------------------|-------------------------|
| 6401M | Momentum, Beeline, Canvas | Momentum, Beeline, Canvas | Studio Teak Stain | Wood, Studio Teak Stain |



COOPER COLLECTION - HUNTSVILLE Lounge Seating

Designed for today's healthcare facilities
Single Seater with arms

Standard Features

- Separate seat and back
- Wood arms
- Wood components in Beech, in any of 9 standard stains or stain-to-match at no upcharge
- Wall-saving frame
- Velcro removable back covers
- Replaceable seats
- Threaded replaceable glides
- Use in connected layouts at no upcharge
- Ships assembled
- Ships 1/carton 15 cu ft

Options

- Replaceable rounded polyurethane arms (P) available in Black, add \$134 List
- Connected and freestanding tables
- Antibacterial and antimicrobial fabrics available
- Different fabric on seat and back at no upcharge
- CAL 133

Contact Spec™ Customer Service to railroad fabrics (specify repeat info and yardage requirement will be provided) and for repeats greater than 5" x 5"



Single Seater with arms

COM 1.75 yds
0.75 yd COM per single seat
1.0 yd COM per single back

| MODEL | COM | GR 1 | GR 2 | GR 3 | GR 4 | GR 5 | GR 6 |
|--------------|-------------|-------------|-------------|-------------|-------------|-------------|-------------|
| 6401M | 1107 | 1199 | 1226 | 1288 | 1379 | 1447 | 1538 |

Dimensions (inches)

| | | | | | |
|---------|-------|---------|-------|-------|------|
| seat H | 18.0 | seat W | 21.0 | arm H | 25.0 |
| total H | 33.75 | total W | 25.25 | depth | 27.5 |

Exceeds BIFMA Seating Durability Test to 500 lbs per chair
CAL 133, add \$120 List per seat



6401M
40 lbs



COOPER COLLECTION - HUNTSVILLE Lounge Seating

Designed for today's healthcare facilities
Two and Three Seaters with outside arms

Standard Features

- Separate seat and back
- Wood arms
- Wood components in Beech, in any of 9 standard stains or stain-to-match at no upcharge
- Wall-saving frame
- Velcro removable back covers
- Replaceable seats
- Threaded replaceable glides
- Use in connected layouts at no upcharge
- Ships assembled
- Ships 1/carton 26 cu ft (2 seater), 1/carton 39 cu ft (3 seater)

Options

- Replaceable rounded polyurethane arms (P) available in Black, add \$134 List
- Connected and freestanding tables
- Antibacterial and antimicrobial fabrics available
- Different fabric on seat and back at no upcharge
- CAL 133

Contact Spec Customer Service to railroad fabrics (specify repeat info and yardage requirement will be provided) and for repeats greater than 5" x 5"



Two Seater with outside arms

COM 3.5 yds
0.75 yd COM per single seat
1.0 yd COM per single back

| MODEL | COM | GR 1 | GR 2 | GR 3 | GR 4 | GR 5 | GR 6 |
|--------------|-------------|-------------|-------------|-------------|-------------|-------------|-------------|
| 6402M | 1588 | 1769 | 1828 | 1950 | 2130 | 2270 | 2449 |

Dimensions (inches)

| | | | | | |
|---------|-------|---------|------|-------|------|
| seat H | 18.0 | seat W | 21.0 | arm H | 25.0 |
| total H | 33.75 | total W | 46.5 | depth | 27.5 |

Exceeds BIFMA Seating Durability Test to 750 lbs per two seater
CAL 133, add \$240 List per two seater



6402M
66 lbs

Three Seater with outside arms

COM 5.25 yds
0.75 yd COM per single seat
1.0 yd COM per single back

| MODEL | COM | GR 1 | GR 2 | GR 3 | GR 4 | GR 5 | GR 6 |
|--------------|-------------|-------------|-------------|-------------|-------------|-------------|-------------|
| 6403M | 2070 | 2342 | 2433 | 2614 | 2885 | 3091 | 3361 |

Dimensions (inches)

| | | | | | |
|---------|-------|---------|------|-------|------|
| seat H | 18.0 | seat W | 21.0 | arm H | 25.0 |
| total H | 33.75 | total W | 67.5 | depth | 27.5 |

Exceeds BIFMA Seating Durability Test to 1000 lbs three seater
CAL 133, add \$360 List per three seater



6403M
92 lbs

COOPER COLLECTION - HUNTSVILLE Lounge Seating

Designed for today's healthcare facilities
Two and Three Seaters with half arms

Standard Features

- Separate seat and back
- Wood arms
- Wood components in Beech, in any of 9 standard stains or stain-to-match at no upcharge
- Wall-saving frame
- Velcro removable back covers
- Replaceable seats
- Threaded replaceable glides
- Use in connected layouts at no upcharge
- Ships assembled
- Ships 1/carton 26 cu ft (2 seater), 1/carton 39 cu ft (3 seater)

Options

- Replaceable rounded polyurethane arms (P) available in Black, add \$201 List for 6412M, or \$268 List for 6413M
- Connected and freestanding tables
- Antibacterial and antimicrobial fabrics available
- Different fabric on seat and back at no upcharge
- CAL 133

Contact Spec Customer Service to railroad fabrics (specify repeat info and yardage requirement will be provided) and for repeats greater than 5" x 5"



Two Seater with half arms

COM 3.5 yds
0.75 yd COM per single seat
1.0 yd COM per single back

| MODEL | COM | GR 1 | GR 2 | GR 3 | GR 4 | GR 5 | GR 6 |
|-------|------|------|------|------|------|------|------|
| 6412M | 2049 | 2229 | 2289 | 2409 | 2592 | 2729 | 2908 |

Dimensions (inches)

| | | | | | |
|---------|-------|---------|------|-------|------|
| seat H | 18.0 | seat W | 21.0 | arm H | 25.0 |
| total H | 33.75 | total W | 48.0 | depth | 27.5 |

Exceeds BIFMA Seating Durability Test to 750 lbs per two seater
CAL 133, add \$240 List per two seater



6412M
68 lbs

Three Seater with half arms

COM 5.25 yds
0.75 yd COM per single seat
1.0 yd COM per single back

| MODEL | COM | GR 1 | GR 2 | GR 3 | GR 4 | GR 5 | GR 6 |
|-------|------|------|------|------|------|------|------|
| 6413M | 2991 | 3260 | 3351 | 3533 | 3803 | 4010 | 4281 |

Dimensions (inches)

| | | | | | |
|---------|-------|---------|------|-------|------|
| seat H | 18.0 | seat W | 21.0 | arm H | 25.0 |
| total H | 33.75 | total W | 70.5 | depth | 27.5 |

Exceeds BIFMA Seating Durability Test to 1000 lbs per three seater
CAL 133, add \$360 List per three seater



6413M
96 lbs



COOPER COLLECTION - HUNTSVILLE Lounge Seating

Designed for today's healthcare facilities

Two and Three Seaters with full arms

Standard Features

- Separate seat and back
- Wood arms
- Wood components in Beech, in any of 9 standard stains or stain-to-match at no upcharge
- Wall-saving frame
- Velcro removable back covers
- Replaceable seats
- Threaded replaceable glides
- Use in connected layouts at no upcharge
- Ships assembled
- Ships 1/carton 26 cu ft (2 seater), 1/carton 39 cu ft (3 seater)

Options

- Replaceable rounded polyurethane arms (P) available in Black, add \$201 List for 6422M, or \$268 List for 6423M
- Connected and freestanding tables
- Antibacterial and antimicrobial fabrics available
- Different fabric on seat and back at no upcharge
- CAL 133

Contact Spec Customer Service to railroad fabrics (specify repeat info and yardage requirement will be provided) and for repeats greater than 5" x 5"

Two Seater with full arms

COM 3.5 yds
0.75 yd COM per single seat
1.0 yd COM per single back

| MODEL | COM | GR 1 | GR 2 | GR 3 | GR 4 | GR 5 | GR 6 |
|-------|------|------|------|------|------|------|------|
| 6422M | 2049 | 2229 | 2289 | 2409 | 2592 | 2729 | 2908 |

Dimensions (inches)

| | | | | | |
|---------|-------|---------|------|-------|------|
| seat H | 18.0 | seat W | 21.0 | arm H | 25.0 |
| total H | 33.75 | total W | 48.0 | depth | 27.5 |

Exceeds BIFMA Seating Durability Test to 750 lbs per two seater
CAL 133, add \$240 List per two seater



6422M
73 lbs

Three Seater with full arms

COM 5.25 yds
0.75 yd COM per single seat
1.0 yd COM per single back

| MODEL | COM | GR 1 | GR 2 | GR 3 | GR 4 | GR 5 | GR 6 |
|-------|------|------|------|------|------|------|------|
| 6423M | 2991 | 3260 | 3351 | 3533 | 3803 | 4010 | 4281 |

Dimensions (inches)

| | | | | | |
|---------|-------|---------|------|-------|------|
| seat H | 18.0 | seat W | 21.0 | arm H | 25.0 |
| total H | 33.75 | total W | 70.5 | depth | 27.5 |

Exceeds BIFMA Seating Durability Test to 1000 lbs per three seater
CAL 133, add \$360 List per three seater



6423M
99 lbs



COOPER COLLECTION - HUNTSVILLE Lounge Seating

Designed for today's healthcare facilities

Loveseat with arms

Standard Features

- Separate seat and back
- Wood arms
- Wood components in Beech, in any of 9 standard stains or stain-to-match at no upcharge
- Wall-saving frame
- Velcro removable back covers
- Replaceable seats
- Threaded replaceable glides
- Use in connected layouts at no upcharge
- Ships assembled
- Ships 1/carton 20 cu ft

Options

- Replaceable rounded polyurethane arms (P) available in Black, add \$134 List
- Connected and freestanding tables
- Antibacterial and antimicrobial fabrics available
- Different fabric on seat and back at no upcharge
- CAL 133

Contact Spec Customer Service to railroad fabrics (specify repeat info and yardage requirement will be provided) and for repeats greater than 5" x 5"



Loveseat with arms

COM 4.0 yds
2.0 yd COM per single seat
2.0 yd COM per single back

| MODEL | COM | GR 1 | GR 2 | GR 3 | GR 4 | GR 5 | GR 6 |
|--------------|-------------|-------------|-------------|-------------|-------------|-------------|-------------|
| 6401L | 1719 | 1930 | 2000 | 2143 | 2349 | 2512 | 2725 |

Dimensions (inches)

| | | | | | |
|---------|-------|---------|-------|-------|------|
| seat H | 18.0 | seat W | 42.0 | arm H | 25.0 |
| total H | 33.75 | total W | 44.75 | depth | 27.5 |

Exceeds BIFMA Seating Durability Test to 750 lbs per chair
CAL 133, add \$184 List per chair



6401L
66 lbs



COOPER COLLECTION - HUNTSVILLE Lounge Seating

Designed for today's healthcare facilities
Bariatric Single Seater with arms

Standard Features

- Separate seat and back
- Wood arms
- Wood components in Beech, in any of 9 standard stains or stain-to-match at no upcharge
- Wall-saving frame
- Velcro removable back covers
- Replaceable seats
- Threaded replaceable glides
- Use in connected layouts at no upcharge
- Bariatric seating cannot connect to bariatric seating
- Ships assembled
- Ships 1/carton 20 cu ft

Options

- Replaceable rounded polyurethane arms (P) available in Black, add \$134 List
- Connected and freestanding tables
- Antibacterial and antimicrobial fabrics available
- Different fabric on seat and back at no upcharge
- CAL 133

Contact Spec Customer Service to railroad fabrics (specify repeat info and yardage requirement will be provided) and for repeats greater than 5" x 5"



Bariatric Single Seater with arms

COM 3.0 yds
1.5 yd COM per single seat
1.5 yd COM per single back

| MODEL | COM | GR 1 | GR 2 | GR 3 | GR 4 | GR 5 | GR 6 |
|--------------|-------------|-------------|-------------|-------------|-------------|-------------|-------------|
| 6401G | 1315 | 1493 | 1554 | 1675 | 1855 | 1995 | 2175 |

Dimensions (inches)

| | | | | | |
|---------|-------|---------|-------|-------|------|
| seat H | 18.0 | seat W | 30.0 | arm H | 25.0 |
| total H | 33.75 | total W | 34.25 | depth | 27.5 |

Exceeds BIFMA Seating Durability Test to 750 lbs per chair
CAL 133, add \$150 List per chair



6401G
47 lbs



COOPER COLLECTION - HUNTSVILLE Lounge Seating

Designed for today's healthcare facilities
 Highback Single Seater with arms – Ottoman

Standard Features

- Separate seat and back
- Wood arms
- Wood components in Beech, in any of 9 standard stains or stain-to-match at no upcharge
- Use in connected layouts at no upcharge
- Velcro removable back covers
- Replaceable seats
- Arms replaceable in the field
- Ships assembled
- Ships 1/carton 19 cu ft
- Ottoman ships 1/carton 5 cu ft

Options

- Replaceable rounded polyurethane arms (P) available in Black, add \$134 List
- Vinyl insert on top of the back, add \$44 List/seat back
- Connected and freestanding tables
- Antibacterial and antimicrobial fabrics available
- Different fabric on seat and back at no upcharge
- CAL 133

Contact Spec Customer Service to railroad fabrics (specify repeat info and yardage requirement will be provided) and for repeats greater than 5" x 5"



Highback Single Seater with arms

COM 2.5 yds
 0.75 yd COM per single seat
 1.75 yds COM per single back

| MODEL | COM | GR 1 | GR 2 | GR 3 | GR 4 | GR 5 | GR 6 |
|--------------|-------------|-------------|-------------|-------------|-------------|-------------|-------------|
| 6401H | 1184 | 1324 | 1371 | 1466 | 1607 | 1715 | 1896 |

Dimensions (inches)

| | | | | | |
|---------|------|---------|------|-------|------|
| seat H | 18.0 | seat W | 21.0 | arm H | 25.0 |
| total H | 47.5 | total W | 25.5 | depth | 27.5 |

Exceeds BIFMA Seating Durability Test to 500 lbs per chair
 CAL 133, add \$134 List per chair



6401H
43 lbs

Ottoman

0.5 yd COM per ottoman

| MODEL | COM | GR 1 | GR 2 | GR 3 | GR 4 | GR 5 | GR 6 |
|--------------|------------|------------|------------|------------|------------|------------|------------|
| 6430F | 537 | 572 | 582 | 607 | 644 | 671 | 720 |

Ottoman Dimensions (inches)

| | | | | | |
|---|------|---|-------|-------|-------|
| H | 11.5 | W | 19.25 | depth | 12.25 |
|---|------|---|-------|-------|-------|

CAL 133, add \$55 List



6430F
16 lbs



COOPER COLLECTION - HUNTSVILLE Lounge Seating

Designed for today's healthcare facilities
Half and Full Panel Arms

Options

- Antibacterial and antimicrobial fabrics available
- CAL 133

To order half panel arms, add Z to model number, e.g. 6401**Z**

To order full panel arms, add ZC to model number, e.g. 6401**ZC**

Pricing is for one half panel arm, e.g. for a single seater chair with half panel arms, add two half panel arms to cost of chair

Contact Spec Customer Service to railroad fabrics (specify repeat info and yardage requirement will be provided) and for repeats greater than 5" x 5"



Half & Full Panel Arms

COM 0.5 yds per half panel arm

| MODEL | COM | GR 1 | GR 2 | GR 3 | GR 4 | GR 5 | GR 6 |
|----------|-----------|------------|------------|------------|------------|------------|------------|
| Z | 77 | 102 | 108 | 124 | 149 | 166 | 193 |

COM 0.75 yds per full panel arm

| MODEL | COM | GR 1 | GR 2 | GR 3 | GR 4 | GR 5 | GR 6 |
|-----------|------------|------------|------------|------------|------------|------------|------------|
| ZC | 147 | 191 | 207 | 236 | 282 | 318 | 348 |

CAL 133, add \$43 List per half panel arm/ \$85 List per full panel arm



1.5 lbs per half panel arm



3 lbs per full panel arm

COOPER COLLECTION - HUNTSVILLE Lounge Seating

Designed for today's healthcare facilities

Freestanding Lounge Tables – Corner and Spacer Connecting Tables

Standard Features

- Tops in laminate or veneer
- Select laminate tops from 15 standard laminates or choose any standard Wilsonart, Nevamar, Formica, Arborite and Pionite matte finish laminates at no upcharge.
- Freestanding lounge tables available with PVC Flat (PVF), 2mm (2MM), exposed Baltic Birch plywood (PF, PKNR) or hardwood (HB) edge
- Connecting table tops available with PVC Flat (PVF) edge, Self edge (SE) or hardwood (HB) edge
- 9 standard veneer and hardwood edge stains. Stain-to-match available at no upcharge.
- Beech legs and Beech table skirts stained the same
- Threaded replaceable glides
- Tops utilize NU Green earth friendly core
- 18" height

Options

- Non-standard laminates, contact Spec for pricing
- Custom size spacer tables for restricted spaces
- Other sizes may be available

Radius Corner Tables are recommended for open areas

Freestanding Lounge Tables

| Model | Laminate PVF/SE/2MM | Laminate PF/PKNR/HB | Veneer HB | Weight | Cu.Ft. |
|-----------------|------------------------|------------------------|--------------|--------|--------|
| 64 - 24 x 24 SQ | 901 | 1096 | 1250 | 47 | 7.2 |
| 64 - 24 x 48 RE | 1063 | 1277 | 1494 | 64 | 18 |
| 64 - 30 x 30 SQ | 1008 | 1149 | 1316 | 57 | 13.5 |
| 64 - 22 DIA | 1056 | 1415 | 1619 | 47 | 7.2 |



Corner and Spacer Connecting Tables

| Model | Laminate PVF/SE | Laminate HB Edge | Veneer HB Edge | Weight | Cu.Ft. |
|--|--------------------|---------------------|-------------------|--------|--------|
| 64RC - 28 x 28 <i>Radius Corner Table</i> | 832 | 1116 | 1308 | 42 | 2 |
| 64SC - 28 x 28 <i>Square Corner Table</i> | 909 | 1104 | 1218 | 46 | 2 |
| 64TC - 45 degree <i>Corner Table</i> | 832 | 1116 | 1308 | 40 | 2 |
| 64ST - 21 x 24 <i>Spacer Table</i> | 565 | 797 | 913 | 27 | 2 |
| 64ET - 21 x 24 <i>End Table</i> | 754 | 986 | 1103 | 37 | 2 |

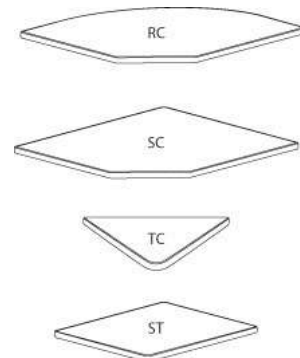

COOPER COLLECTION - MIDLAND Lounge Seating

LAYOUTS



Description

- Spec's Midland offers a lighter, residential feel at a value price with extensive environmental considerations.
- Your layout possibilities are unlimited with spacer, radius and corner tables – for both standard and bariatric seating in virtually any combination.
- Bariatric seating is a 30" wide seat and is load tested to 750 lbs. Cannot be connected to other bariatric seats.
- 21" seat width is standard.
- Standard in European Beech in any of 9 standard stains or stain-to-match at no upcharge.
- Choice of wood or polyurethane arm caps which are replaceable in the field.
- All models offer a choice of no center arms, half arms or full arms to the floor.
- Wall-saving frame is standard to protect both wall and fabric.
- Glides and separate seat and back are standard.
- Please send a drawing of the configuration you require with your order.
- Ships assembled as one, two and three seater units.
- For fabrics you wish railroaded or repeats larger than 5" x 5", please contact the factory with repeat information and yardage requirement will be provided.



LAYOUTS AND DIMENSIONS

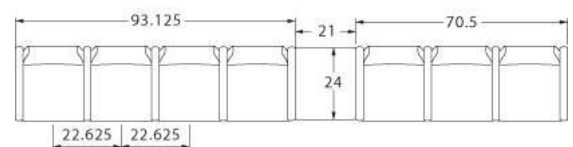
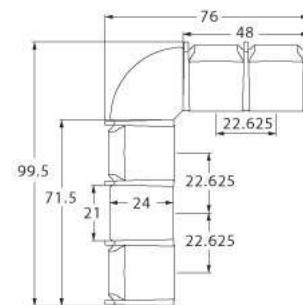
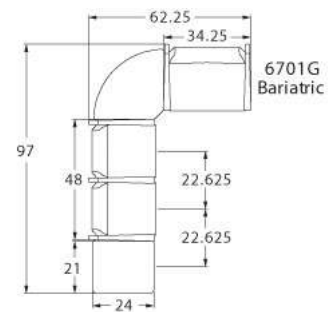



COOPER COLLECTION - MIDLAND Lounge Seating



PRODUCT CODE

6 7 2 3 M



OPTIONS

ARM CAP



Polyurethane

FINISHES

FRAME



Select from one of our 9 standard wood stains or stain-to-match at no upcharge

FABRIC



Select fabrics from one of our textile partners

ARM CAP



Black

See Spectone Card or specfurniture.com/materials/finishes for a complete list of finish options and colors.



COOPER COLLECTION - MIDLAND Lounge Seating

BACK TO CONTENTS

HOW TO ORDER

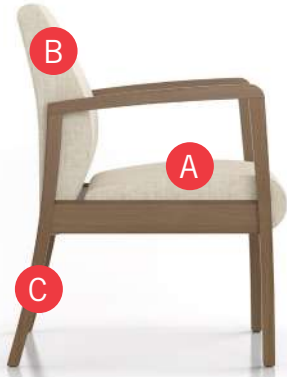

Specify Model

- A** Specify Fabric - Seat¹
Manufacturer, Pattern Name, Color
- B** Specify Fabric - Back¹
Manufacturer, Pattern Name, Color
- C** Specify Frame Finish

Optional: Polyurethane Arm Cap, CAL 133, Moisture Barrier, Connecting and Freestanding Tables, Ottoman, Vinyl Headrest Insert

¹ When multiple fabrics are specified on two and three seat chairs, please provide a drawing and legend for fabric placement.



| Model | Fabric - Seat | Fabric - Back | Frame Finish |
|-------|---------------------------|---------------------------|-------------------|
| 6701M | Momentum, Beeline, Canvas | Momentum, Beeline, Canvas | Studio Teak Stain |



COOPER COLLECTION - MIDLAND Lounge Seating

Designed for today's healthcare facilities
Single Seater with arms

Standard Features

- Separate seat and back
- Wood components in Beech, in any of 9 standard stains or stain-to-match at no upcharge
- Wall-saving frame
- Velcro removable back covers
- Replaceable seats
- Threaded replaceable glides
- Use in connected layouts at no upcharge
- Ships assembled as 1, 2 or 3 seaters
- Ships 1/carton 15 cu ft

Options

- Replaceable polyurethane arm cap (P) available in Black, add \$98 List
- Connected and freestanding tables
- Antibacterial and antimicrobial fabrics available
- Different fabric on seat and back at no upcharge
- CAL 133

Contact Spec™ Customer Service to railroad fabrics (specify repeat info and yardage requirement will be provided) and for repeats greater than 5" x 5"



Single Seater with arms

COM 1.75 yds
0.75 yd COM per single seat
1.0 yd COM per single back

| MODEL | COM | GR 1 | GR 2 | GR 3 | GR 4 | GR 5 | GR 6 |
|--------------|------------|------------|-------------|-------------|-------------|-------------|-------------|
| 6701M | 904 | 995 | 1023 | 1085 | 1173 | 1244 | 1333 |

Dimensions (inches)

| | | | | | |
|---------|-------|---------|-------|-------|-------|
| seat H | 18.0 | seat W | 21.0 | arm H | 25.0 |
| total H | 33.75 | total W | 25.25 | depth | 26.25 |

Exceeds BIFMA Seating Durability Test to 500 lbs per chair
CAL 133, add \$120 List per seat



6701M
36 lbs

COOPER COLLECTION - MIDLAND Lounge Seating

Designed for today's healthcare facilities
Two and Three Seaters with outside arms

Standard Features

- Separate seat and back
- Wood components in Beech, in any of 9 standard stains or stain-to-match at no upcharge
- Wall-saving frame
- Velcro removable back covers
- Replaceable seats
- Threaded replaceable glides
- Use in connected layouts at no upcharge
- Ships assembled as 1, 2 or 3 seaters
- Ships 1/carton 26 cu ft (2 seater),
1/carton 39 cu ft (3 seater)

Options

- Replaceable polyurethane arm cap (P) available in Black, add \$98 List
- Connected and freestanding tables
- Antibacterial and antimicrobial fabrics available
- Different fabric on seat and back at no upcharge
- CAL 133

Contact Spec Customer Service to railroad fabrics (specify repeat info and yardage requirement will be provided) and for repeats greater than 5" x 5"



Two Seater with outside arms

COM 3.5 yds
0.75 yd COM per single seat
1.0 yd COM per single back

| MODEL | COM | GR 1 | GR 2 | GR 3 | GR 4 | GR 5 | GR 6 |
|-------|------|------|------|------|------|------|------|
| 6702M | 1408 | 1590 | 1648 | 1772 | 1949 | 2087 | 2271 |

Dimensions (inches)

| | seat H | 18.0 | seat W | 21.0 | arm H | 25.0 |
|---------|--------|---------|--------|-------|-------|------|
| total H | 33.75 | total W | 44.75 | depth | 26.25 | |

Exceeds BIFMA Seating Durability Test to 750 lbs per two seater
CAL 133, add \$240 List per two seater



6702M
62 lbs

Three Seater with outside arms

COM 5.25 yds
0.75 yd COM per single seat
1.0 yd COM per single back

| MODEL | COM | GR 1 | GR 2 | GR 3 | GR 4 | GR 5 | GR 6 |
|-------|------|------|------|------|------|------|------|
| 6703M | 1941 | 2211 | 2297 | 2487 | 2750 | 2959 | 3233 |

Dimensions (inches)

| | seat H | 18.0 | seat W | 21.0 | arm H | 25.0 |
|---------|--------|---------|--------|-------|-------|------|
| total H | 33.75 | total W | 67.5 | depth | 26.25 | |

Exceeds BIFMA Seating Durability Test to 1000 lbs per three seater
CAL 133, add \$360 List per three seater



6703M
88 lbs



COOPER COLLECTION - MIDLAND Lounge Seating

Designed for today's healthcare facilities
Two and Three Seaters with half arms

Standard Features

- Separate seat and back
- Wood components in Beech, in any of 9 standard stains or stain-to-match at no upcharge
- Wall-saving frame
- Velcro removable back covers
- Replaceable seats
- Threaded replaceable glides
- Use in connected layouts at no upcharge
- Ships assembled as 1, 2 or 3 seaters
- Ships 1/carton 26 cu ft (2 seater),
1/carton 39 cu ft (3 seater)

Options

- Replaceable polyurethane arm caps (P) available in Black, add \$147 List for 6712M, or \$196 List for 6713M
- Connected and freestanding tables
- Antibacterial and antimicrobial fabrics available
- Different fabric on seat and back at no upcharge
- CAL 133

Contact Spec Customer Service to railroad fabrics (specify repeat info and yardage requirement will be provided) and for repeats greater than 5" x 5"



Two Seater with half arms

COM 3.5 yds
0.75 yd COM per single seat
1.0 yd COM per single back

| MODEL | COM | GR 1 | GR 2 | GR 3 | GR 4 | GR 5 | GR 6 |
|--------------|-------------|-------------|-------------|-------------|-------------|-------------|-------------|
| 6712M | 1590 | 1770 | 1828 | 1953 | 2129 | 2270 | 2451 |

Dimensions (inches)

| | | | | | |
|---------|-------|---------|------|-------|-------|
| seat H | 18.0 | seat W | 21.0 | arm H | 25.0 |
| total H | 33.75 | total W | 48.0 | depth | 26.25 |

Exceeds BIFMA Seating Durability Test to 750 lbs two seater
CAL 133, add \$240 List per two seater



6712M
64 lbs

Three Seater with half arms

COM 5.25 yds
0.75 yd COM per single seat
1.0 yd COM per single back

| MODEL | COM | GR 1 | GR 2 | GR 3 | GR 4 | GR 5 | GR 6 |
|--------------|-------------|-------------|-------------|-------------|-------------|-------------|-------------|
| 6713M | 2326 | 2598 | 2684 | 2871 | 3136 | 3346 | 3618 |

Dimensions (inches)

| | | | | | |
|---------|-------|---------|------|-------|-------|
| seat H | 18.0 | seat W | 21.0 | arm H | 25.0 |
| total H | 33.75 | total W | 70.5 | depth | 26.25 |

Exceeds BIFMA Seating Durability Test to 1000 lbs per three seater
CAL 133, add \$360 List per three seater



6713M
92 lbs



COOPER COLLECTION - MIDLAND Lounge Seating

Designed for today's healthcare facilities

Two and Three Seaters with full arms

Standard Features

- Separate seat and back
- Wood components in Beech, in any of 9 standard stains or stain-to-match at no upcharge
- Wall-saving frame
- Velcro removable back covers
- Replaceable seats
- Threaded replaceable glides
- Use in connected layouts at no upcharge
- Ships assembled as 1, 2 or 3 seaters
- Ships 1/carton 26 cu ft (2 seater), 1/carton 39 cu ft (3 seater)

Options

- Replaceable polyurethane arm caps (P) available in Black, add \$147 List for 6722M, or \$196 List for 6723M
- Connected and freestanding tables
- Antibacterial and antimicrobial fabrics available
- Different fabric on seat and back at no upcharge
- CAL 133

Contact Spec Customer Service to railroad fabrics (specify repeat info and yardage requirement will be provided) and for repeats greater than 5" x 5"



Two Seater with full arms

COM 3.5 yds
0.75 yd COM per single seat
1.0 yd COM per single back

| MODEL | COM | GR 1 | GR 2 | GR 3 | GR 4 | GR 5 | GR 6 |
|--------------|-------------|-------------|-------------|-------------|-------------|-------------|-------------|
| 6722M | 1590 | 1770 | 1828 | 1953 | 2129 | 2270 | 2451 |

Dimensions (inches)

| | | | | | |
|---------|-------|---------|------|-------|-------|
| seat H | 18.0 | seat W | 21.0 | arm H | 25.0 |
| total H | 33.75 | total W | 48.0 | depth | 26.25 |

Exceeds BIFMA Seating Durability Test to 750 lbs per two seater
CAL 133, add \$240 List per two seater



6722M
69 lbs

Three Seater with full arms

COM 5.25 yds
0.75 yd COM per single seat
1.0 yd COM per single back

| MODEL | COM | GR 1 | GR 2 | GR 3 | GR 4 | GR 5 | GR 6 |
|--------------|-------------|-------------|-------------|-------------|-------------|-------------|-------------|
| 6723M | 2326 | 2598 | 2684 | 2871 | 3136 | 3346 | 3618 |

Dimensions (inches)

| | | | | | |
|---------|-------|---------|------|-------|-------|
| seat H | 18.0 | seat W | 21.0 | arm H | 25.0 |
| total H | 33.75 | total W | 70.5 | depth | 26.25 |

Exceeds BIFMA Seating Durability Test to 1000 lbs per three seater
CAL 133, add \$360 List per three seater



6723M
93 lbs



COOPER COLLECTION - MIDLAND Lounge Seating

Designed for today's healthcare facilities

Loveseat with arms

Standard Features

- Separate seat and back
- Wood components in Beech, in any of 9 standard stains or stain-to-match at no upcharge
- Wall-saving frame
- Velcro removable back covers
- Replaceable seats
- Threaded replaceable glides
- Use in connected layouts at no upcharge
- Ships assembled as 1, 2 or 3 seaters
- Ships 1/carton 20 cu ft

Options

- Replaceable polyurethane arm cap (P) available in Black, add \$98 List
- Connected and freestanding tables
- Antibacterial and antimicrobial fabrics available
- Different fabric on seat and back at no upcharge
- CAL 133

Contact Spec Customer Service to railroad fabrics (specify repeat info and yardage requirement will be provided) and for repeats greater than 5" x 5"



Loveseat with arms

COM 4.0 yds
2.0 yd COM per single seat
2.0 yd COM per single back

| MODEL | COM | GR 1 | GR 2 | GR 3 | GR 4 | GR 5 | GR 6 |
|--------------|-------------|-------------|-------------|-------------|-------------|-------------|-------------|
| 6701L | 1385 | 1597 | 1665 | 1810 | 2014 | 2178 | 2391 |

Dimensions (inches)

| | | | | | |
|---------|-------|---------|-------|-------|-------|
| seat H | 18.0 | seat W | 42.0 | arm H | 25.0 |
| total H | 33.75 | total W | 46.25 | depth | 26.25 |

Exceeds BIFMA Seating Durability Test to 750 lbs per chair
CAL 133, add \$184 List per chair



6701L
62 lbs



COOPER COLLECTION - MIDLAND Lounge Seating

Designed for today's healthcare facilities
Bariatric Single Seater with arms

Standard Features

- Separate seat and back
- Wood components in Beech, in any of 9 standard stains or stain-to-match at no upcharge
- Wall-saving frame
- Velcro removable back covers
- Replaceable seats
- Threaded replaceable glides
- Use in connected layouts at no upcharge
- Ships assembled as 1, 2 or 3 seaters
- Ships 1/carton 20 cu ft

Options

- Replaceable polyurethane arm cap (P) available in Black, add \$98 List
- Connected and freestanding tables
- Antibacterial and antimicrobial fabrics available
- Different fabric on seat and back at no upcharge
- CAL 133

Contact Spec Customer Service to railroad fabrics (specify repeat info and yardage requirement will be provided) and for repeats greater than 5" x 5"



Bariatric Single Seater with arms

COM 3.0 yds
1.5 yd COM per single seat
1.5 yd COM per single back

| MODEL | COM | GR 1 | GR 2 | GR 3 | GR 4 | GR 5 | GR 6 |
|--------------|-------------|-------------|-------------|-------------|-------------|-------------|-------------|
| 6701G | 1176 | 1356 | 1414 | 1539 | 1714 | 1854 | 2036 |

Dimensions (inches)

| | | | | | |
|---------|-------|---------|-------|-------|-------|
| seat H | 18.0 | seat W | 30.0 | arm H | 25.0 |
| total H | 33.75 | total W | 34.25 | depth | 26.25 |

Exceeds BIFMA Seating Durability Test to 750 lbs per chair
CAL 133, add \$150 List per chair



6701G
43 lbs



COOPER COLLECTION - MIDLAND Lounge Seating

Designed for today's healthcare facilities
 Highback Single Seater with arms – Ottoman

Standard Features

- Separate seat and back
- Wood components in Beech, in any of 9 standard stains or stain-to-match at no upcharge
- Wall-saving frame
- Threaded replaceable glides
- Use in connected layouts at no upcharge
- Ships assembled as 1, 2 or 3 seaters
- Ships 1/carton 20 cu ft
- Ottoman ships 1/carton 5 cu ft

Options

- Replaceable polyurethane arm cap (P) available in Black, add \$98 List
- Vinyl insert on top of the back, add \$44 List/seat back
- Connected and freestanding tables
- Antibacterial and antimicrobial fabrics available
- Different fabric on seat and back at no upcharge
- CAL 133

Contact Spec Customer Service to railroad fabrics (specify repeat info and yardage requirement will be provided) and for repeats greater than 5" x 5"



Highback Single Seater with arms

COM 2.5 yds
 0.75 yd COM per single seat
 1.75 yds COM per single back

| MODEL | COM | GR 1 | GR 2 | GR 3 | GR 4 | GR 5 | GR 6 |
|-------|------|------|------|------|------|------|------|
| 6701H | 1047 | 1200 | 1248 | 1351 | 1499 | 1614 | 1766 |

Dimensions (inches)

| | seat H | 18.0 | seat W | 21.0 | arm H | 25.0 |
|---------|--------|---------|--------|-------|-------|------|
| total H | 47.5 | total W | 25.25 | depth | 26.25 | |

Exceeds BIFMA Seating Durability Test to 500 lbs per chair
 CAL 133, add \$134 List per chair



6701H
39 lbs

Ottoman

COM 0.5 yd

| MODEL | COM | GR 1 | GR 2 | GR 3 | GR 4 | GR 5 | GR 6 |
|-------|-----|------|------|------|------|------|------|
| 6730F | 565 | 601 | 614 | 635 | 672 | 700 | 747 |

Dimensions (inches)

| H | 11.5 | W | 19.25 | depth | 12.25 |
|---|------|---|-------|-------|-------|
|---|------|---|-------|-------|-------|

CAL 133, add \$55 List per Ottoman



6730F
16 lbs

COOPER COLLECTION - MIDLAND Lounge Seating

Designed for today's healthcare facilities

Freestanding Lounge Tables – Corner and Spacer Connecting Tables

Standard Features

- Tops in laminate or veneer
- Select laminate tops from 15 standard laminates or choose any standard Wilsonart, Nevamar, Formica, Arborite and Pionite matte finish laminates at no upcharge.
- Freestanding lounge tables available with PVC Flat (PVF), 2mm (2MM), exposed Baltic Birch plywood (PF, PKNR) or hardwood (HB) edge
- Connecting table tops available with PVC Flat (PVF) edge, Self edge (SE) or hardwood (HB) edge
- 9 standard veneer and hardwood edge stains. Stain-to-match available at no upcharge.
- Beech legs and Beech table skirts stained the same
- Tops utilize NU Green earth friendly core
- Threaded replaceable glides
- 18" height

Options

- Non-standard laminates, contact Spec for pricing
- Custom size spacer tables for restricted spaces
- Self edge available at same cost as PVC Flat (PVF) edge
- Other sizes may be available

Radius Corner Tables are recommended for open areas

Freestanding Lounge Tables

| Model | Laminate PVF/SE/2MM | Laminate PF/PKNR/HB | Veneer HB | Weight | Cu.Ft. |
|-----------------|------------------------|------------------------|--------------|--------|--------|
| 67 - 24 x 24 SQ | 901 | 1096 | 1250 | 47 | 7.2 |
| 67 - 24 x 48 RE | 1063 | 1277 | 1494 | 64 | 18 |
| 67 - 30 x 30 SQ | 1008 | 1149 | 1316 | 57 | 13.5 |
| 67 - 22 DIA | 1056 | 1415 | 1619 | 47 | 7.2 |



Corner and Spacer Connecting Tables

| Model | Laminate PVF/SE | Laminate HB Edge | Veneer HB Edge | Weight | Cu.Ft. |
|--|--------------------|---------------------|-------------------|--------|--------|
| 67RC - 28 x 28 <i>Radius Corner Table</i> | 832 | 1116 | 1308 | 42 | 2 |
| 67SC - 28 x 28 <i>Square Corner Table</i> | 909 | 1104 | 1218 | 46 | 2 |
| 67TC - 45 degree <i>Corner Table</i> | 832 | 1116 | 1308 | 40 | 2 |
| 67ST - 21 x 24 <i>Spacer Table</i> | 565 | 797 | 913 | 27 | 2 |
| 67ET - 21 x 24 <i>End Table</i> | 754 | 986 | 1103 | 37 | 2 |

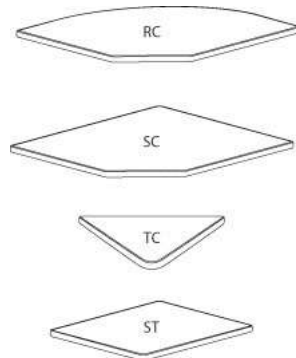

COOPER COLLECTION - COOPER ROCKS Lounge Seating



PRODUCT CODE

6 7 01 HR

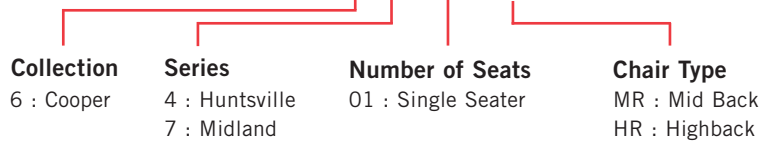

OPTIONS

BACK OPTIONS



Highback

Mid Back

FINISHES

FRAME



Select from one of our 9 standard wood stains or stain-to-match at no upcharge

FABRIC



Select fabrics from one of our textile partners

ARM OPTIONS

Arm options will vary depending on the Series. Please refer to the price list for more information on the Series you would like to specify.

COOPER COLLECTION - COOPER ROCKS Lounge Seating

Designed for today's healthcare facilities
Huntsville Medium and Highback with arms

Standard Features

- Separate seat and back
- Built in headrest on highback
- Total range of motion is 2" down and 6" back
- Wood arms
- Wood components in Beech, in any of 9 standard stains or stain-to-match at no upcharge
- Wall-saving frame
- Velcro removable back covers
- Replaceable seats
- Threaded replaceable glides
- Ships assembled
- Ships 1/carton 15 cu ft (medium back), 1/carton 19 cu ft (highback)

Options

- Rounded polyurethane arms, field-replaceable
- Matching ottoman
- Removable headrest
- No headrest
- Antibacterial and antimicrobial fabrics available
- Different fabric on seat and back at no upcharge
- CAL 133

Contact Spec Customer Service to railroad fabrics (specify repeat info and yardage requirement will be provided) and for repeats greater than 5" x 5"

Huntsville Medium back with arms

COM 1.75 yds
0.75 yd COM per single seat
1.0 yd COM per single back

| MODEL | COM | GR 1 | GR 2 | GR 3 | GR 4 | GR 5 | GR 6 |
|---------------|-------------|-------------|-------------|-------------|-------------|-------------|-------------|
| 6401MR | 1592 | 1684 | 1712 | 1773 | 1865 | 1933 | 2024 |

For polyurethane arms add suffix P and \$134

Dimensions (inches)

| seat H | 18.0 | seat W | 21.0 | arm H | 25.0 |
|---------|-------|---------|-------|-------|------|
| total H | 33.75 | total W | 25.25 | depth | 27.5 |

Exceeds BIFMA Seating Durability Test to 350 lbs per seat
CAL 133, add \$120 List per seat



6401MR
46 lbs

Hunstville Highback with arms

COM 2.5 yds
0.75 yd COM per single seat
1.75 yd COM per single back

| MODEL | COM | GR 1 | GR 2 | GR 3 | GR 4 | GR 5 | GR 6 |
|---------------|-------------|-------------|-------------|-------------|-------------|-------------|-------------|
| 6401HR | 1836 | 1980 | 2027 | 2122 | 2262 | 2370 | 2552 |

For polyurethane arms add suffix P and \$134

Dimensions (inches)

| seat H | 18.0 | seat W | 21.0 | arm H | 25.0 |
|---------|------|---------|------|-------|------|
| total H | 47.5 | total W | 25.5 | depth | 27.5 |

Exceeds BIFMA Seating Durability Test to 350 lbs per seat
CAL 133, add \$134 List per seat



6401HR
50 lbs



COOPER COLLECTION - COOPER ROCKS Lounge Seating

Designed for today's healthcare facilities
Midland Medium and Highback with arms

Standard Features

- Separate seat and back
- Built in headrest on highback
- Total range of motion is 2" down and 6" back
- Wood arms
- Wood components in Beech, in any of 9 standard stains or stain-to-match at no upcharge
- Wall-saving frame
- Velcro removable back covers
- Replaceable seats
- Threaded replaceable glides
- Ships assembled
- Ships 1/carton 15 cu ft (medium back), 1/carton 19 cu ft (highback)

Options

- Replaceable polyurethane arm caps, add \$98 List
- Matching ottoman
- Removable headrest
- No headrest
- Antibacterial and antimicrobial fabrics available
- Different fabric on seat and back at no upcharge
- CAL 133

Contact Spec Customer Service to railroad fabrics (specify repeat info and yardage requirement will be provided) and for repeats greater than 5" x 5"



Midland Medium back with arms

COM 1.75 yds
0.75 yd COM per single seat
1.0 yd COM per single back

| MODEL | COM | GR 1 | GR 2 | GR 3 | GR 4 | GR 5 | GR 6 |
|--------|------|------|------|------|------|------|------|
| 6701MR | 1402 | 1492 | 1522 | 1583 | 1671 | 1742 | 1832 |

Dimensions (inches)

| | | | | | |
|---------|-------|---------|------|-------|------|
| seat H | 18.0 | seat W | 21.0 | arm H | 25.0 |
| total H | 33.75 | total W | 25.5 | depth | 27.5 |

Exceeds BIFMA Seating Durability Test to 350 lbs per seat
CAL 133, add \$120 List per seat



6701MR
44 lbs

Midland Highback with arms

COM 2.5 yds
0.75 yd COM per single seat
1.75 yd COM per single back

| MODEL | COM | GR 1 | GR 2 | GR 3 | GR 4 | GR 5 | GR 6 |
|--------|------|------|------|------|------|------|------|
| 6701HR | 1707 | 1857 | 1906 | 2008 | 2158 | 2273 | 2425 |

Dimensions (inches)

| | | | | | |
|---------|------|---------|------|-------|------|
| seat H | 18.0 | seat W | 21.0 | arm H | 25.0 |
| total H | 47.5 | total W | 25.5 | depth | 27.5 |

Exceeds BIFMA Seating Durability Test to 350 lbs per seat
CAL 133, add \$134 List per seat



6701HR
48 lbs



CRAYON Children's Series



PRODUCT CODE



FINISHES

LAMINATE



Select from 15 standard laminates or choose any standard Wilsonart, Nevamar, Formica, Arborite and Pionite matte finish laminates at no upcharge

BASE



Select from one of our 76 standard Spectone colors

EDGE



See Spectone Card or specfurniture.com/materials/finishes for a complete list of finish options and colors.

HOW TO ORDER

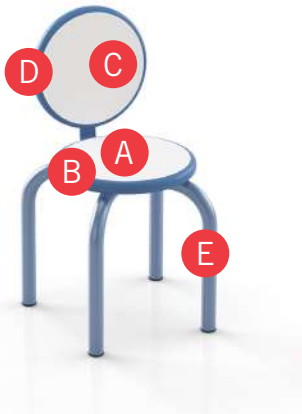

Specify Model

- A** Specify Laminate Surface - Seat
Manufacturer, Laminate Name, Laminate Code
- B** Specify Edge Type and Color - Seat
PVC Flat
- C** Specify Laminate Surface - Back
Manufacturer, Laminate Name, Laminate Code
- D** Specify Edge Type and Color - Back
PVC Flat
- E** Specify Base Finish

Optional: Custom Solutions

| Model | Laminate Surface - Seat | Edge Type and Color - Seat | Laminate Surface - Back | Edge Type and Color - Back | Base Finish |
|-------|------------------------------------|----------------------------|------------------------------------|----------------------------|-------------|
| 4001 | Wilsonart, Designer White, D354-60 | PVC Flat, RAL 5007 | Wilsonart, Designer White, D354-60 | PVC Flat, RAL 5007 | RAL 5007 |



CRAYON Children's Series

Stool and Chair without arms

Standard Features

- Seat is an 12" laminate disk
- Back is an 11" laminate disk
- Select from 15 standard laminates or choose any standard Wilsonart, Nevamar, Formica, Arborite and Pionite matte finish laminates at no upcharge. For other laminate please contact the factory for pricing.
- 1.25" fully welded frame in any Spectone color
- 1" NU Green earth friendly core
- Edge is PVC Flat (PVF) with 38 colors available to match base finishes
- Seat height 14"
- Glides
- Ships 2/carton 2 cu ft

Options

- Non-standard laminates, contact Spec for pricing



Stool

MODEL PRICE
4001 237

Dimensions (inches)

| | | | | | |
|---------|------|---------|------|-------|------|
| seat H | 14.0 | seat W | 12.0 | arm H | N/A |
| total H | 14.0 | total W | 14.0 | depth | 14.0 |



Chair without arms

MODEL PRICE
4002 342

Dimensions (inches)

| | | | | | |
|---------|------|---------|------|--------|------|
| seat H | 14.0 | seat W | 12.0 | back W | 11.0 |
| total H | 26.0 | total W | 14.0 | depth | 16.0 |





CRAYON Children's Series

Freestanding Table

Standard Features

- Select from 15 standard laminates or choose any standard Wilsonart, Nevamar, Formica, Arborite and Pionite matte finish laminates at no upcharge. For other laminate please contact the factory for pricing.
- 1.50" post legs in any Spectone color
- 1" NU Green earth friendly core
- Edge is PVC Flat (PVF) with 38 colors available to match base finishes
- Height 22"
- Glides
- Top and base ship in separate cartons

Options

- Non-standard laminates, contact Spec for pricing



Freestanding Table

| Model | Top Size (inches) | Laminate PVC Flat Edge | Weight | Cu.Ft. |
|-------|-------------------|------------------------|--------|--------|
| 4004 | 24 DIA | 504 | 31 | 11 |
| | 30 DIA | 608 | 41 | 16 |
| | 36 DIA | 707 | 52 | 22 |
| | 24 SQ | 536 | 31 | 11 |
| | 30 SQ | 643 | 41 | 16 |
| | 24 x 48 | 698 | 48 | 20 |



4004

DIGNITY Behavioral Health Series



PRODUCT CODE

4501M - UU

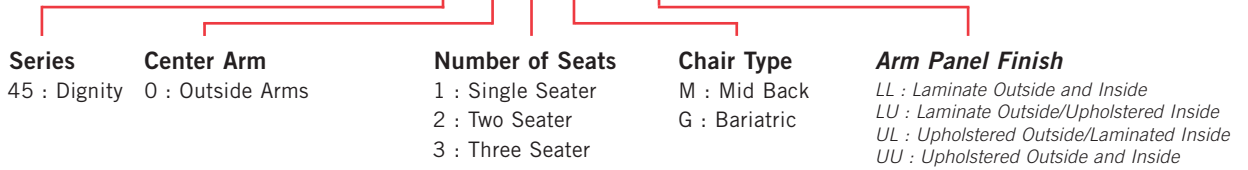

OPTIONS

SEAT PAN



FINISHES

FRAME / ARMS



LAMINATE

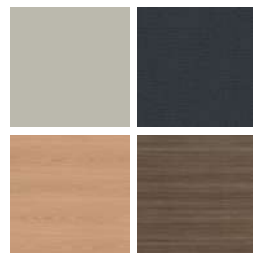

Select from 15 standard laminates or choose any standard Wilsonart, Nevamar, Formica, Arborite and Pionite matte finish laminates at no upcharge

FABRIC

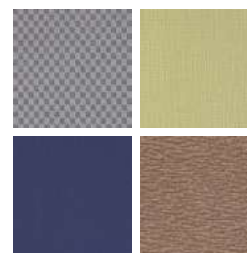

Select fabrics from one of our textile partners

See Spectone Card or specfurniture.com/materials/finishes for a complete list of finish options and colors.

DIGNITY Behavioral Health Series

BACK TO CONTENTS

HOW TO ORDER

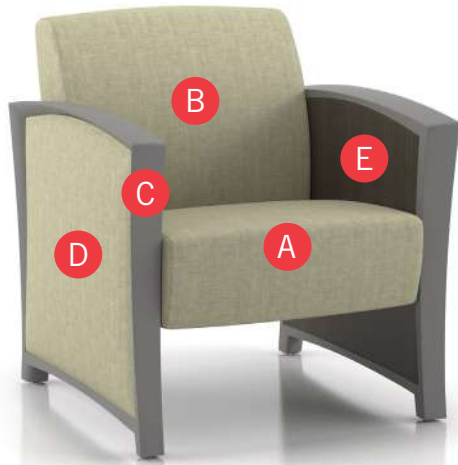

Specify Model

- A** Specify Fabric - Seat¹
Manufacturer, Pattern Name, Color
- B** Specify Fabric - Back¹
Manufacturer, Pattern Name, Color
- C** Specify Frame Finish
- D** Specify Outside/Inside Panel Finish
- E** *For Laminate Panels: Manufacturer, Laminate Name, Laminate Code*
For Fabric Panels: Manufacturer, Pattern Name, Color

Optional: Additional Weight, Floor Mounting Straps, Elimination of Separated Seat and Back, CAL 133, Moisture Barrier, Connecting and Freestanding Tables, Dolly

¹ When multiple fabrics are specified on two and three seat chairs, please provide a drawing and legend for fabric placement.

| Model | Fabric - Seat | Fabric - Back | Frame Finish | Outside Panel | Inside Panel |
|----------|-------------------------------|-------------------------------|---------------|-------------------------------|----------------------------------|
| 4501M-UL | Momentum, Beeline, Eucaliptus | Momentum, Beeline, Eucaliptus | Sterling Grey | Momentum, Beeline, Eucaliptus | Wilsonart, Asian Night, 7949K-18 |





DIGNITY Behavioral Health Series

Standard Features

- Separate seat and back
- Self-skinned polyurethane perimeter arms
- Upholstered side panels can match or contrast seat/back
- Laminate or upholstered side panels on inside and outside of arm
- Select from 15 standard laminates or choose any standard Wilsonart, Nevamar, Formica, Arborite and Pionite matte finish laminates at no upcharge.
- No protruding legs or hardware
- Tamper proof fastenings
- Non-removable steel levelling glides
- Ships assembled
- Ships 1/carton 15 cu ft

Contact Spec Customer Service to railroad fabrics (specify repeat info and yardage requirement will be provided) and for repeats greater than 5" x 5"

Options

- Specify frame finish, Black (B), Sterling Grey (G) or Taupe RAL 7006 (T)
- Add up to 20 lbs of additional weight per seat, add \$162 List per seat
- Non-standard laminates, contact Spec for pricing
- Antibacterial and antimicrobial fabrics available
- Floor mounting straps available, call Customer Service
- Connecting and freestanding tables
- CAL 133
- Elimination of separated seat and back available with either solid or perforated seat pan, call Customer Service

Single Seater with arms

COM 1.75 yds

0.75 yd COM per single seat / 1.0 yd COM per single back

| MODEL | COM | GR 1 | GR 2 | GR 3 | GR 4 | GR 5 | GR 6 |
|-----------------|-------------|-------------|-------------|-------------|-------------|-------------|-------------|
| 4501M-LL | 1474 | 1567 | 1597 | 1658 | 1749 | 1819 | 1909 |

Arm panel – laminated, outside and inside
CAL 133, add \$120 List per chair



4501M
107 lbs

COM 2.75 yds

0.75 yd COM per single seat / 1.0 yd COM per single back / .5 yd COM per panel

| MODEL | COM | GR 1 | GR 2 | GR 3 | GR 4 | GR 5 | GR 6 |
|-----------------|-------------|-------------|-------------|-------------|-------------|-------------|-------------|
| 4501M-LU | 1591 | 1736 | 1783 | 1879 | 2023 | 2129 | 2274 |

Arm panel – laminated, outside, upholstered inside
CAL 133, add \$204 List per chair

COM 2.75 yds

0.75 yd COM per single seat / 1.0 yd COM per single back / .5 yd COM per panel

| MODEL | COM | GR 1 | GR 2 | GR 3 | GR 4 | GR 5 | GR 6 |
|-----------------|-------------|-------------|-------------|-------------|-------------|-------------|-------------|
| 4501M-UL | 1591 | 1736 | 1783 | 1879 | 2023 | 2129 | 2274 |

Arm panel – upholstered outside, laminated inside
CAL 133, add \$204 List per chair

COM 3.75 yds

0.75 yd COM per single seat / 1.0 yd COM per single back / 1.0 yd COM per panel

| MODEL | COM | GR 1 | GR 2 | GR 3 | GR 4 | GR 5 | GR 6 |
|-----------------|-------------|-------------|-------------|-------------|-------------|-------------|-------------|
| 4501M-UU | 1707 | 1904 | 1968 | 2100 | 2293 | 2442 | 2637 |

Arm panel – upholstered, outside and inside
CAL 133, add \$284 List per chair

Dimensions (inches)

| | | | | | |
|---------|-------|---------|------|-------|-------|
| seat H | 18.0 | seat W | 23.0 | arm H | 25.25 |
| total H | 32.75 | total W | 29.0 | depth | 29.75 |

Exceeds BIFMA Seating Durability Test to 500 lbs per chair



DIGNITY Behavioral Health Series

Standard Features

- Separate seat and back
- Self-skinned polyurethane perimeter arms
- Upholstered side panels can match or contrast seat/back
- Laminate or upholstered side panels on inside and outside of arm
- Select from 15 standard laminates or choose any standard Wilsonart, Nevamar, Formica, Arborite and Pionite matte finish laminates at no upcharge.
- No protruding legs or hardware
- Tamper proof fastenings
- Non-removable steel levelling glides
- Ships assembled
- Ships 1/carton 26 cu ft

Contact Spec Customer Service to railroad fabrics (specify repeat info and yardage requirement will be provided) and for repeats greater than 5" x 5"

Options

- Specify frame finish, Black (B), Sterling Grey (G) or Taupe RAL 7006 (T)
- Add up to 20 lbs of additional weight per seat, add \$162 List per seat
- Non-standard laminates, contact Spec for pricing
- Antibacterial and antimicrobial fabrics available
- Floor mounting straps available, call Customer Service
- Connecting and freestanding tables
- CAL 133
- Elimination of separated seat and back available with either solid or perforated seat pan, call Customer Service

Two Seater with outside arms

COM 3.5 yds

0.75 yd COM per single seat / 1.0 yd COM per single back

| MODEL | COM | GR 1 | GR 2 | GR 3 | GR 4 | GR 5 | GR 6 |
|-----------------|-------------|-------------|-------------|-------------|-------------|-------------|-------------|
| 4502M-LL | 2166 | 2349 | 2409 | 2531 | 2714 | 2851 | 3035 |

Arm panel – laminated, outside and inside

CAL 133, add \$240 List per two seater



4502M
152 lbs

COM 4.5 yds

0.75 yd COM per single seat / 1.0 yd COM per single back / .5 yd COM per panel

| MODEL | COM | GR 1 | GR 2 | GR 3 | GR 4 | GR 5 | GR 6 |
|-----------------|-------------|-------------|-------------|-------------|-------------|-------------|-------------|
| 4502M-LU | 2282 | 2518 | 2597 | 2751 | 2988 | 3165 | 3399 |

Arm panel – laminated, outside, upholstered inside

CAL 133, add \$324 List per two seater

COM 4.5 yds

0.75 yd COM per single seat / 1.0 yd COM per single back / .5 yd COM per panel

| MODEL | COM | GR 1 | GR 2 | GR 3 | GR 4 | GR 5 | GR 6 |
|-----------------|-------------|-------------|-------------|-------------|-------------|-------------|-------------|
| 4502M-UL | 2282 | 2518 | 2597 | 2751 | 2988 | 3165 | 3399 |

Arm panel – upholstered outside, laminated inside

CAL 133, add \$324 List per two seater

COM 5.5 yds

0.75 yd COM per single seat / 1.0 yd COM per single back / 1.0 yd COM per panel

| MODEL | COM | GR 1 | GR 2 | GR 3 | GR 4 | GR 5 | GR 6 |
|-----------------|-------------|-------------|-------------|-------------|-------------|-------------|-------------|
| 4502M-UU | 2397 | 2686 | 2781 | 2972 | 3258 | 3475 | 3766 |

Arm panel – upholstered, outside and inside

CAL 133, add \$408 List per two seater

Dimensions (inches)

| | | | | | |
|---------|-------|---------|------|-------|-------|
| seat H | 18.0 | seat W | 46.0 | arm H | 25.25 |
| total H | 32.75 | total W | 52.0 | depth | 29.75 |

Exceeds BIFMA Seating Durability Test to 750 lbs per two seater



DIGNITY Behavioral Health Series

Standard Features

- Separate seat and back
- Self-skinned polyurethane perimeter arms
- Upholstered side panels can match or contrast seat/back
- Laminate or upholstered side panels on inside and outside of arm
- Select from 15 standard laminates or choose any standard Wilsonart, Nevamar, Formica, Arborite and Pionite matte finish laminates at no upcharge.
- No protruding legs or hardware
- Tamper proof fastenings
- Non-removable steel levelling glides
- Ships assembled
- Ships 1/carton 39 cu ft

Contact Spec Customer Service to railroad fabrics (specify repeat info and yardage requirement will be provided) and for repeats greater than 5" x 5"

Options

- Specify frame finish, Black (B), Sterling Grey (G) or Taupe RAL 7006 (T)
- Add up to 20 lbs of additional weight per seat, add \$162 List per seat
- Non-standard laminates, contact Spec for pricing
- Antibacterial and antimicrobial fabrics available
- Floor mounting straps available, call Customer Service
- Connecting and freestanding tables
- CAL 133
- Elimination of separated seat and back available with either solid or perforated seat pan, call Customer Service



Three Seater with outside arms

COM 5.25 yds

0.75 yd COM per single seat / 1.0 yd COM per single back

| MODEL | COM | GR 1 | GR 2 | GR 3 | GR 4 | GR 5 | GR 6 |
|-----------------|-------------|-------------|-------------|-------------|-------------|-------------|-------------|
| 4503M-LL | 2856 | 3132 | 3224 | 3406 | 3680 | 3886 | 4162 |

Arm panel – laminated, outside and inside

CAL 133, add \$360 List per three seater



4503M
197 lbs

COM 6.25 yds

0.75 yd COM per single seat / 1.0 yd COM per single back / .5 yd COM per panel

| MODEL | COM | GR 1 | GR 2 | GR 3 | GR 4 | GR 5 | GR 6 |
|-----------------|-------------|-------------|-------------|-------------|-------------|-------------|-------------|
| 4503M-LU | 2971 | 3300 | 3408 | 3628 | 3953 | 4197 | 4526 |

Arm panel – laminated, outside, upholstered inside

CAL 133, add \$444 List per three seater

COM 6.25 yds

0.75 yd COM per single seat / 1.0 yd COM per single back / .5 yd COM per panel

| MODEL | COM | GR 1 | GR 2 | GR 3 | GR 4 | GR 5 | GR 6 |
|-----------------|-------------|-------------|-------------|-------------|-------------|-------------|-------------|
| 4503M-UL | 2971 | 3300 | 3408 | 3628 | 3953 | 4197 | 4526 |

Arm panel – upholstered outside, laminated inside

CAL 133, add \$444 List per three seater

COM 7.25 yds

0.75 yd COM per single seat / 1.0 yd COM per single back / 1.0 yd COM per panel

| MODEL | COM | GR 1 | GR 2 | GR 3 | GR 4 | GR 5 | GR 6 |
|-----------------|-------------|-------------|-------------|-------------|-------------|-------------|-------------|
| 4503M-UU | 3088 | 3470 | 3595 | 3848 | 4223 | 4509 | 4892 |

Arm panel – upholstered, outside and inside

CAL 133, add \$528 List per three seater

Dimensions (inches)

| | | | | | |
|---------|-------|---------|------|-------|-------|
| seat H | 18.0 | seat W | 69.0 | arm H | 25.25 |
| total H | 32.75 | total W | 75.0 | depth | 29.75 |

Exceeds BIFMA Seating Durability Test to 1000 lbs per three seater



DIGNITY Behavioral Health Series

Standard Features

- Separate seat and back
- Self-skinned polyurethane perimeter arms
- Upholstered side panels can match or contrast seat/back
- Laminate or upholstered side panels on inside and outside of arm
- Select from 15 standard laminates or choose any standard Wilsonart, Nevamar, Formica, Arborite and Pionite matte finish laminates at no upcharge.
- No protruding legs or hardware
- Tamper proof fastenings
- Non-removable steel levelling glides
- Ships assembled
- Ships 1/carton 20 cu ft

Contact Spec Customer Service to railroad fabrics (specify repeat info and yardage requirement will be provided) and for repeats greater than 5" x 5"

Options

- Specify frame finish, Black (B), Sterling Grey (G) or Taupe RAL 7006 (T)
- Add up to 20 lbs of additional weight per seat, add \$162 List per seat
- Non-standard laminates, contact Spec for pricing
- Antibacterial and antimicrobial fabrics available
- Floor mounting straps available, call Customer Service
- Connecting and freestanding tables
- CAL 133
- Elimination of separated seat and back available with either solid or perforated seat pan, call Customer Service



Bariatric Single Seater with arms

COM 3.25 yds

1.5 yd COM per single seat / 1.75 yd COM per single back

| MODEL | COM | GR 1 | GR 2 | GR 3 | GR 4 | GR 5 | GR 6 |
|-----------------|-------------|-------------|-------------|-------------|-------------|-------------|-------------|
| 4501G-LL | 1907 | 2079 | 2134 | 2247 | 2417 | 2546 | 2716 |

Arm panel – laminated, outside and inside

CAL 133, add \$154 List per chair



4501G
116 lbs

COM 4.25 yds

1.5 yd COM per single seat / 1.75 yd COM per single back / .5 yd COM per panel

| MODEL | COM | GR 1 | GR 2 | GR 3 | GR 4 | GR 5 | GR 6 |
|-----------------|-------------|-------------|-------------|-------------|-------------|-------------|-------------|
| 4501G-LU | 2024 | 2247 | 2320 | 2467 | 2688 | 2855 | 3078 |

Arm panel – laminated, outside, upholstered inside

CAL 133, add \$233 List per chair

COM 4.25 yds

1.5 yd COM per single seat / 1.75 yd COM per single back / .5 yd COM per panel

| MODEL | COM | GR 1 | GR 2 | GR 3 | GR 4 | GR 5 | GR 6 |
|-----------------|-------------|-------------|-------------|-------------|-------------|-------------|-------------|
| 4501G-UL | 2024 | 2247 | 2320 | 2467 | 2688 | 2855 | 3078 |

Arm panel – upholstered outside, laminated inside

CAL 133, add \$233 List per chair

COM 5.25 yds

1.5 yd COM per single seat / 1.75 yd COM per single back / 1.0 yd COM per panel

| MODEL | COM | GR 1 | GR 2 | GR 3 | GR 4 | GR 5 | GR 6 |
|-----------------|-------------|-------------|-------------|-------------|-------------|-------------|-------------|
| 4501G-UU | 2140 | 2416 | 2506 | 2688 | 2963 | 3170 | 3447 |

Arm panel – upholstered, outside and inside

CAL 133, add \$312 List per chair

Dimensions (inches)

| | | | | | |
|---------|-------|---------|-------|-------|-------|
| seat H | 18.0 | seat W | 30.25 | arm H | 25.25 |
| total H | 32.75 | total W | 36.25 | depth | 29.75 |

Exceeds BIFMA Seating Durability Test to 750 lbs per chair

DIGNITY Behavioral Health Series

Standard Features

- Tops in laminate or veneer
- Select from 15 standard laminates or choose any standard Wilsonart, Nevamar, Formica, Arborite and Pionite matte finish laminates at no upcharge.
- Laminate tops with PVC Flat (PVF), Self Edge (SE), or hardwood (HB) edge
- 9 standard veneer and hardwood edge stains. Stain-to-match available at no upcharge.
- Tops utilize NU Green earth friendly core
- 18" height
- Non-removable steel levelling glides

Radius Corner Tables are recommended for open areas

Options

- Specify frame finish, Black (B), Sterling Grey (G) or Taupe RAL 7006 (T)
- Additional weight can be added, contact factory
- Non-standard laminates, contact Spec for pricing
- Floor mounting straps available, call Customer Service

Freestanding Lounge Tables

| Model | Laminate PVF/SE Edge | Laminate HB Edge | Veneer HB Edge | Weight | Cu.Ft. |
|-------------------|-------------------------|---------------------|-------------------|--------|--------|
| DIGN - 24 x 24 SQ | 1221 | 1418 | 1455 | 57 | 7.2 |
| DIGN - 30 x 30 SQ | 1376 | 1518 | 1569 | 74 | 13.5 |
| DIGN - 36 x 36 SQ | 1503 | 1725 | 1787 | 94 | 18 |
| DIGN - 42 x 42 SQ | 1826 | 2149 | 2247 | 116 | 24.5 |
| DIGN - 48 x 48 SQ | 2023 | 2306 | 2411 | 141 | 32 |
| DIGN - 24 DIA | 1191 | 1550 | 1588 | 45 | 7.2 |
| DIGN - 30 DIA | 1343 | 1695 | 1744 | 57 | 13.5 |
| DIGN - 36 DIA | 1483 | 1998 | 2085 | 71 | 18 |
| DIGN - 42 DIA | 1815 | 2388 | 2511 | 87 | 24.5 |
| DIGN - 48 DIA | 1877 | 2651 | 2785 | 104 | 32 |



Corner and Spacer Connecting Tables

| Model | Laminate PVF/SE | Laminate HB Edge | Veneer HB Edge | Weight | Cu.Ft. |
|--|--------------------|---------------------|-------------------|-----------|----------|
| DIGNRC - 28 x 28 <i>Radius Corner Table</i> | 704 | 882 | 1091 | 31 | 2 |
| DIGNSC - 28 x 28 <i>Square Corner Table</i> | 704 | 882 | 1091 | 32 | 2 |
| DIGNTC - 45 degree <i>Corner Table</i> | 704 | 882 | 1091 | 26 | 2 |
| DIGNST - 21 x 24 <i>Spacer Table</i> | 542 | 738 | 890 | 27 | 2 |

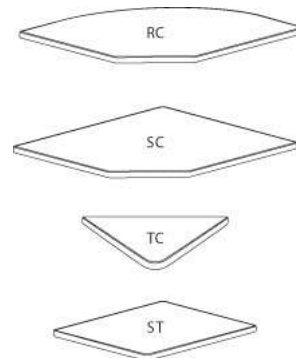

DIGNITY Behavioral Health Series

Standard Features

- Black finish only
- 6" soft wheel casters
- Standard Dolly holds 1 single seat chair
- Ships 1/carton, 17 cu. ft.
- Ships assembled



Dignity - Dolly

| Description | Model | Price | Weight |
|-------------------|----------------|------------|-------------|
| Single Seat Dolly | DIGN-99 | 557 | 12lb |

Dimensions (inches)

| | |
|--------|------|
| height | 39.0 |
| width | 23.0 |
| depth | 30.0 |





DIGNITY2 Behavioral Health Series



PRODUCT CODE





4601M-N-UU

| Series | Center Arm | Number of Seats | Chair Type | Arm Type | Arm Panel Finish |
|---------------|------------------|---|-------------------------------|---------------------------------|--|
| 46 : Dignity2 | 0 : Outside Arms | 1 : Single Seater 2 : Two Seater 3 : Three Seater | M : Mid Back G : Bariatric | N/A : Regular Arm N : No Arm | LL : Laminate Outside and Inside LU : Laminate Outside/Upholstered Inside UL : Upholstered Outside/Laminated Inside UU : Upholstered Outside and Inside |

OPTIONS

| ARM TYPE | WALL SAVING | EXTENDED SIDE PANEL | SEAT PAN |
|---|---|--|---|
|    |  |  |  |
| <p>Polyurethane Wood KYDEX®</p> <p><i>Corian arms available. Call for pricing.</i> <i>End arm caps only.</i></p> | | | |

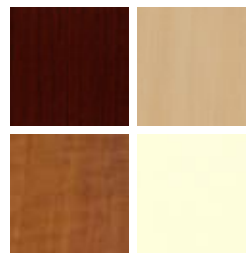
FINISHES

| ARM PANEL LAMINATE | FABRIC | ARMS | ARM PANEL THERMOFOIL | FRAME |
|---|--|---|--|---|
|  <p>Select from 15 standard laminates or choose any standard Wilsonart, Nevamar, Formica, Arborite and Pionite matte finish laminates at no upcharge</p> |  <p>Select fabrics from one of our textile partners</p> |  <p>Black Sterling Grey</p> <p>Taupe</p> <p>Select from one of our 9 standard wood stains or stain-to-match at no upcharge</p> |  <p>Select from one of our 8 standard Thermofoil finishes</p> |  <p>Select from one of our 76 standard Spectone colors</p> |

See Spectone Card or specfurniture.com/materials/finishes for a complete list of finish options and colors.

DIGNITY2 Behavioral Health Series

BACK TO CONTENTS

HOW TO ORDER

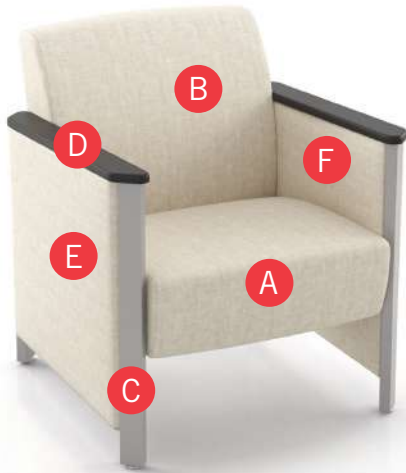

Specify Model

- A** Specify Fabric - Seat¹
Manufacturer, Pattern Name, Color
- B** Specify Fabric - Back¹
Manufacturer, Pattern Name, Color
- C** Specify Frame Finish
- D** Specify Arm Cap Type and Color
Polyurethane / Wood / KYDEX® (\$)
- E** Specify Outside/Inside Panel Finish
F *For Laminate Panels: Manufacturer, Laminate Name, Laminate Code*
For Fabric Panels: Manufacturer, Pattern Name, Color

Optional: KYDEX® Arm Cap, Thermofoil side panels, Additional Weight, Floor Mounting Straps, Wall Saving, Extended Side Panel, Elimination of Separated Seat and Back, CAL 133, Moisture Barrier, Connecting and Freestanding Tables, Dolly

¹ When multiple fabrics are specified on two and three seat chairs, please provide a drawing and legend for fabric placement.

| Model | Fabric - Seat | Fabric - Back | Frame Finish | Arm Cap Type and Color | Outside Panel | Inside Panel |
|----------|---------------------------|---------------------------|--------------|------------------------|---------------------------|---------------------------|
| 4601M-LU | Momentum, Beeline, Canvas | Momentum, Beeline, Canvas | Silver | Polyurethane, Black | Momentum, Beeline, Canvas | Momentum, Beeline, Canvas |



DIGNITY2 Behavioral Health Series

Standard Features

- Separate seat and back
- Arm caps available in wood, or polyurethane
- Laminate or upholstered side panels on inside and outside of arm in various combinations
- Upholstered side panels can match or contrast seat/back
- Select from 15 standard laminates or choose any standard Wilsonart, Nevamar, Formica, Arborite and Pionite matte finish laminates at no upcharge.
- Sculpted steel leg in any Spectone finish
- No protruding legs or hardware
- Tamper proof fastenings
- Non-removable steel levelling glides
- Ships assembled
- Ships 1/carton 15 cu ft

Options

- Polyurethane arm caps available in Black (B) or Taupe RAL 7006 (T) or Sterling Grey (G)
- For wood arm caps, select from 9 standard stains, or stain-to-match at no upcharge
- KYDEX® arm caps available in Black (B) or Taupe RAL 7006 (T) or Sterling Grey (G)
- Thermofoil side panels on inside and outside of arm, call Customer Service for pricing and finishes
- Add up to 20 lbs of additional weight per seat, add \$162 List per seat
- Non-standard laminates, contact Spec for pricing
- Antibacterial and antimicrobial fabrics available
- Floor mounting straps available, call Customer Service
- Connecting and freestanding tables
- CAL 133
- Elimination of separated seat and back available with either solid or perforated seat pan, call Customer Service

Contact Spec Customer Service to railroad fabrics (specify repeat info and yardage requirement will be provided) and for repeats greater than 5" x 5"

Single Seater with arms

COM 1.75 yds
0.75 yd COM per single seat / 1.0 yd COM per single back

| MODEL | COM | GR 1 | GR 2 | GR 3 | GR 4 | GR 5 | GR 6 |
|-----------------|-------------|-------------|-------------|-------------|-------------|-------------|-------------|
| 4601M-LL | 1474 | 1567 | 1597 | 1658 | 1749 | 1819 | 1909 |

Side panel – laminated, outside and inside
CAL 133, add \$120 List per chair

COM 2.75 yds
0.75 yd COM per single seat / 1.0 yd COM per single back / .5 yd COM per panel

| MODEL | COM | GR 1 | GR 2 | GR 3 | GR 4 | GR 5 | GR 6 |
|-----------------|-------------|-------------|-------------|-------------|-------------|-------------|-------------|
| 4601M-LU | 1591 | 1736 | 1783 | 1879 | 2023 | 2129 | 2274 |

Side panel – laminated, outside, upholstered inside
CAL 133, add \$204 List per chair

COM 2.75 yds
0.75 yd COM per single seat / 1.0 yd COM per single back / .5 yd COM per panel

| MODEL | COM | GR 1 | GR 2 | GR 3 | GR 4 | GR 5 | GR 6 |
|-----------------|-------------|-------------|-------------|-------------|-------------|-------------|-------------|
| 4601M-UL | 1591 | 1736 | 1783 | 1879 | 2023 | 2129 | 2274 |

Side panel – upholstered outside, laminated inside
CAL 133, add \$204 List per chair

COM 3.75 yds
0.75 yd COM per single seat / 1.0 yd COM per single back / 1.0 yd COM per panel

| MODEL | COM | GR 1 | GR 2 | GR 3 | GR 4 | GR 5 | GR 6 |
|-----------------|-------------|-------------|-------------|-------------|-------------|-------------|-------------|
| 4601M-UU | 1707 | 1904 | 1968 | 2100 | 2293 | 2442 | 2637 |

Side panel – upholstered, outside and inside
CAL 133, add \$284 List per chair

Dimensions (inches)

| | | | | | |
|---------|-------|---------|------|-------|------|
| seat H | 18.0 | seat W | 23.0 | arm H | 26.0 |
| total H | 31.75 | total W | 28.5 | depth | 30.0 |

For KYDEX® arms add suffix K and \$262
Dynamic load tested to 500 lbs per chair



4601M
94 lbs



DIGNITY2 Behavioral Health Series

Standard Features

- Separate seat and back
- Arm caps available in wood, or polyurethane
- Laminate or upholstered side panels on inside and outside of arm in various combinations
- Upholstered side panels can match or contrast seat/back
- Select from 15 standard laminates or choose any standard Wilsonart, Nevamar, Formica, Arborite and Pionite matte finish laminates at no upcharge.
- Sculpted steel leg in any Spectone finish
- No protruding legs or hardware
- Tamper proof fastenings
- Non-removable steel levelling glides
- Ships assembled
- Ships 1/carton 15 cu ft

Options

- Polyurethane arm caps available in Black (B) or Taupe RAL 7006 (T) or Sterling Grey (G)
- For wood arm caps, select from 9 standard stains, or stain-to-match at no upcharge
- KYDEX® arm caps available in Black (B) or Taupe RAL 7006 (T) or Sterling Grey (G)
- Thermofoil side panels on inside and outside of arm, call Customer Service for pricing and finishes
- Add up to 20 lbs of additional weight per seat, add \$162 List per seat
- Non-standard laminates, contact Spec for pricing
- Antibacterial and antimicrobial fabrics available
- Floor mounting straps available, call Customer Service
- Connecting and freestanding tables
- CAL 133
- Elimination of separated seat and back available with either solid or perforated seat pan, call Customer Service

Contact Spec Customer Service to railroad fabrics (specify repeat info and yardage requirement will be provided) and for repeats greater than 5" x 5"

Two Seater with outside arms

COM 3.5 yds
0.75 yd COM per single seat / 1.0 yd COM per single back

| MODEL | COM | GR 1 | GR 2 | GR 3 | GR 4 | GR 5 | GR 6 |
|-----------------|-------------|-------------|-------------|-------------|-------------|-------------|-------------|
| 4602M-LL | 2166 | 2349 | 2409 | 2531 | 2714 | 2851 | 3035 |

Side panel – laminated, outside and inside
CAL 133, add \$240 List per two seater



4602M
148 lbs

COM 4.5 yds
0.75 yd COM per single seat / 1.0 yd COM per single back / .5 yd COM per panel

| MODEL | COM | GR 1 | GR 2 | GR 3 | GR 4 | GR 5 | GR 6 |
|-----------------|-------------|-------------|-------------|-------------|-------------|-------------|-------------|
| 4602M-UL | 2282 | 2518 | 2597 | 2751 | 2988 | 3165 | 3399 |

Side panel – laminated, outside, upholstered inside
CAL 133, add \$324 List per two seater

COM 4.5 yds
0.75 yd COM per single seat / 1.0 yd COM per single back / .5 yd COM per panel

| MODEL | COM | GR 1 | GR 2 | GR 3 | GR 4 | GR 5 | GR 6 |
|-----------------|-------------|-------------|-------------|-------------|-------------|-------------|-------------|
| 4602M-UL | 2282 | 2518 | 2597 | 2751 | 2988 | 3165 | 3399 |

Side panel – upholstered outside, laminated inside
CAL 133, add \$324 List per two seater

COM 5.5 yds
0.75 yd COM per single seat / 1.0 yd COM per single back / 1.0 yd COM per panel

| MODEL | COM | GR 1 | GR 2 | GR 3 | GR 4 | GR 5 | GR 6 |
|-----------------|-------------|-------------|-------------|-------------|-------------|-------------|-------------|
| 4602M-UU | 2397 | 2686 | 2781 | 2972 | 3258 | 3475 | 3766 |

Side panel – upholstered, outside and inside
CAL 133, add \$408 List per two seater

Dimensions (inches)

| | | | | | |
|---------|-------|---------|------|-------|------|
| seat H | 18.0 | seat W | 45.5 | arm H | 26.0 |
| total H | 31.75 | total W | 51.0 | depth | 30.0 |

For KYDEX® arms add suffix K and \$262
Dynamic load tested to 750 lbs per two seater



DIGNITY2 Behavioral Health Series

Standard Features

- Separate seat and back
- Arm caps available in wood, or polyurethane
- Laminate or upholstered side panels on inside and outside of arm in various combinations
- Upholstered side panels can match or contrast seat/back
- Select from 15 standard laminates or choose any standard Wilsonart, Nevamar, Formica, Arborite and Pionite matte finish laminates at no upcharge.
- Sculpted steel leg in any Spectone finish
- No protruding legs or hardware
- Tamper proof fastenings
- Non-removable steel levelling glides
- Ships assembled
- Ships 1/carton 15 cu ft

Options

- Polyurethane arm caps available in Black (B) or Taupe RAL 7006 (T) or Sterling Grey (G)
- For wood arm caps, select from 9 standard stains, or stain-to-match at no upcharge
- KYDEX® arm caps available in Black (B) or Taupe RAL 7006 (T) or Sterling Grey (G)
- Thermofoil side panels on inside and outside of arm, call Customer Service for pricing and finishes
- Add up to 20 lbs of additional weight per seat, add \$162 List per seat
- Non-standard laminates, contact Spec for pricing
- Antibacterial and antimicrobial fabrics available
- Floor mounting straps available, call Customer Service
- Connecting and freestanding tables
- CAL 133
- Elimination of separated seat and back available with either solid or perforated seat pan, call Customer Service

Contact Spec Customer Service to railroad fabrics (specify repeat info and yardage requirement will be provided) and for repeats greater than 5" x 5"

Three Seater with outside arms

COM 5.25 yds
0.75 yd COM per single seat / 1.0 yd COM per single back

| MODEL | COM | GR 1 | GR 2 | GR 3 | GR 4 | GR 5 | GR 6 |
|-----------------|-------------|-------------|-------------|-------------|-------------|-------------|-------------|
| 4603M-LL | 2856 | 3132 | 3224 | 3406 | 3680 | 3886 | 4162 |

Side panel – laminated, outside and inside
CAL 133, add \$360 List per three seater

COM 6.25 yds
0.75 yd COM per single seat / 1.0 yd COM per single back / .5 yd COM per panel

| MODEL | COM | GR 1 | GR 2 | GR 3 | GR 4 | GR 5 | GR 6 |
|-----------------|-------------|-------------|-------------|-------------|-------------|-------------|-------------|
| 4603M-LU | 2971 | 3300 | 3408 | 3628 | 3953 | 4197 | 4526 |

Side panel – laminated, outside, upholstered inside
CAL 133, add \$444 List per three seater

COM 6.25 yds
0.75 yd COM per single seat / 1.0 yd COM per single back / .5 yd COM per panel

| MODEL | COM | GR 1 | GR 2 | GR 3 | GR 4 | GR 5 | GR 6 |
|-----------------|-------------|-------------|-------------|-------------|-------------|-------------|-------------|
| 4603M-UL | 2971 | 3300 | 3408 | 3628 | 3953 | 4197 | 4526 |

Side panel – upholstered outside, laminated inside
CAL 133, add \$444 List per three seater

COM 7.25 yds
0.75 yd COM per single seat / 1.0 yd COM per single back / 1.0 yd COM per panel

| MODEL | COM | GR 1 | GR 2 | GR 3 | GR 4 | GR 5 | GR 6 |
|-----------------|-------------|-------------|-------------|-------------|-------------|-------------|-------------|
| 4603M-UU | 3088 | 3470 | 3595 | 3848 | 4223 | 4509 | 4892 |

Side panel – upholstered, outside and inside
CAL 133, add \$528 List per three seater

Dimensions (inches)

| | | | | | |
|---------|-------|---------|------|-------|------|
| seat H | 18.0 | seat W | 68.0 | arm H | 26.0 |
| total H | 31.75 | total W | 74.0 | depth | 30.0 |

For KYDEX® arms add suffix K and \$262
Dynamic load tested to 1000 lbs per three seater



4603M
203 lbs



DIGNITY2 Behavioral Health Series

Standard Features

- Separate seat and back
- Arm caps available in wood, or polyurethane
- Laminate or upholstered side panels on inside and outside of arm in various combinations
- Upholstered side panels can match or contrast seat/back
- Select from 15 standard laminates or choose any standard Wilsonart, Nevamar, Formica, Arborite and Pionite matte finish laminates at no upcharge.
- Sculpted steel leg in any Spectone finish
- No protruding legs or hardware
- Tamper proof fastenings
- Non-removable steel levelling glides
- Ships assembled
- Ships 1/carton 15 cu ft

Options

- Polyurethane arm caps available in Black (B) or Taupe RAL 7006 (T) or Sterling Grey (G)
- For wood arm caps, select from 9 standard stains, or stain-to-match at no upcharge
- KYDEX® arm caps available in Black (B) or Taupe RAL 7006 (T) or Sterling Grey (G)
- Thermofoil side panels on inside and outside of arm, call Customer Service for pricing and finishes
- Add up to 20 lbs of additional weight per seat, add \$162 List per seat
- Non-standard laminates, contact Spec for pricing
- Antibacterial and antimicrobial fabrics available
- Floor mounting straps available, call Customer Service
- Connecting and freestanding tables
- CAL 133
- Elimination of separated seat and back available with either solid or perforated seat pan, call Customer Service

Contact Spec Customer Service to railroad fabrics (specify repeat info and yardage requirement will be provided) and for repeats greater than 5" x 5"

Bariatric Single Seater with arms

COM 3.25 yds

1.5 yd COM per single seat / 1.75 yd COM per single back

| MODEL | COM | GR 1 | GR 2 | GR 3 | GR 4 | GR 5 | GR 6 |
|-----------------|-------------|-------------|-------------|-------------|-------------|-------------|-------------|
| 4601G-LL | 1907 | 2079 | 2134 | 2247 | 2417 | 2546 | 2716 |

Side panel – laminated, outside and inside

CAL 133, add \$154 List per chair

COM 4.25 yds

1.5 yd COM per single seat / 1.75 yd COM per single back / .5 yd COM per panel

| MODEL | COM | GR 1 | GR 2 | GR 3 | GR 4 | GR 5 | GR 6 |
|-----------------|-------------|-------------|-------------|-------------|-------------|-------------|-------------|
| 4601G-LU | 2024 | 2247 | 2320 | 2467 | 2688 | 2855 | 3078 |

Side panel – laminated, outside, upholstered inside

CAL 133, add \$233 List per chair

COM 4.25 yds

1.5 yd COM per single seat / 1.75 yd COM per single back / .5 yd COM per panel

| MODEL | COM | GR 1 | GR 2 | GR 3 | GR 4 | GR 5 | GR 6 |
|-----------------|-------------|-------------|-------------|-------------|-------------|-------------|-------------|
| 4601G-UL | 2024 | 2247 | 2320 | 2467 | 2688 | 2855 | 3078 |

Side panel – upholstered outside, laminated inside

CAL 133, add \$233 List per chair

COM 5.25 yds

1.5 yd COM per single seat / 1.75 yd COM per single back / 1.0 yd COM per panel

| MODEL | COM | GR 1 | GR 2 | GR 3 | GR 4 | GR 5 | GR 6 |
|-----------------|-------------|-------------|-------------|-------------|-------------|-------------|-------------|
| 4601G-UU | 2140 | 2416 | 2506 | 2688 | 2963 | 3170 | 3447 |

Side panel – upholstered, outside and inside

CAL 133, add \$312 List per chair

Dimensions (inches)

| | | | | | |
|---------|-------|---------|------|-------|------|
| seat H | 18.0 | seat W | 31.0 | arm H | 26.0 |
| total H | 31.75 | total W | 36.5 | depth | 30.0 |

For KYDEX® arms add suffix K and \$262
Dynamic load tested to 750 lbs per chair



4601G
112 lbs



DIGNITY2 Behavioral Health Series

Standard Features

- Separate seat and back
- Arm caps available in wood, or polyurethane
- Laminate or upholstered side panels on inside and outside of arm in various combinations
- Upholstered side panels can match or contrast seat/back
- Select from 15 standard laminates or choose any standard Wilsonart, Nevamar, Formica, Arborite and Pionite matte finish laminates at no upcharge.
- Sculpted steel leg in any Spectone finish
- No protruding legs or hardware
- Tamper proof fastenings
- Non-removable steel levelling glides
- Ships assembled
- Ships 1/carton 15 cu ft

Options

- Polyurethane arm caps available in Black (B) or Taupe RAL 7006 (T) or Sterling Grey (G)
- For wood arm caps, select from 9 standard stains, or stain-to-match at no upcharge
- KYDEX® arm caps available in Black (B) or Taupe RAL 7006 (T) or Sterling Grey (G)
- Thermofoil side panels on inside and outside of arm, call Customer Service for pricing and finishes
- Add up to 20 lbs of additional weight per seat, add \$162 List per seat
- Non-standard laminates, contact Spec for pricing
- Antibacterial and antimicrobial fabrics available
- Floor mounting straps available, call Customer Service
- Connecting and freestanding tables
- CAL 133
- Elimination of separated seat and back available with either solid or perforated seat pan, call Customer Service

Contact Spec Customer Service to railroad fabrics (specify repeat info and yardage requirement will be provided) and for repeats greater than 5" x 5"

Single Seater with no arms

COM 1.75 yds
0.75 yd COM per single seat / 1.0 yd COM per single back

| MODEL | COM | GR 1 | GR 2 | GR 3 | GR 4 | GR 5 | GR 6 |
|-------------------|-------------|-------------|-------------|-------------|-------------|-------------|-------------|
| 4601M-LL-N | 1453 | 1544 | 1575 | 1636 | 1727 | 1796 | 1889 |

Side panel – laminated, outside and inside
CAL 133, add \$120 List per chair



4601M-N
90 lbs

COM 2.75 yds
0.75 yd COM per single seat / 1.0 yd COM per single back / .5 yd COM per panel

| MODEL | COM | GR 1 | GR 2 | GR 3 | GR 4 | GR 5 | GR 6 |
|-------------------|-------------|-------------|-------------|-------------|-------------|-------------|-------------|
| 4601M-LU-N | 1568 | 1713 | 1760 | 1856 | 2001 | 2107 | 2251 |

Side panel – laminated, outside, upholstered inside
CAL 133, add \$204 List per chair

COM 2.75 yds
0.75 yd COM per single seat / 1.0 yd COM per single back / .5 yd COM per panel

| MODEL | COM | GR 1 | GR 2 | GR 3 | GR 4 | GR 5 | GR 6 |
|-------------------|-------------|-------------|-------------|-------------|-------------|-------------|-------------|
| 4601M-UL-N | 1568 | 1713 | 1760 | 1856 | 2001 | 2107 | 2251 |

Side panel – upholstered outside, laminated inside
CAL 133, add \$204 List per chair

COM 3.75 yds
0.75 yd COM per single seat / 1.0 yd COM per single back / 1.0 yd COM per panel

| MODEL | COM | GR 1 | GR 2 | GR 3 | GR 4 | GR 5 | GR 6 |
|-------------------|-------------|-------------|-------------|-------------|-------------|-------------|-------------|
| 4601M-UU-N | 1684 | 1882 | 1947 | 2077 | 2272 | 2419 | 2616 |

Side panel – upholstered, outside and inside
CAL 133, add \$284 List per chair

Dimensions (inches)

| | | | | | |
|---------|-------|---------|------|-------|------|
| seat H | 18.0 | seat W | 23.0 | arm H | 17.5 |
| total H | 31.75 | total W | 28.5 | depth | 30.0 |

For KYDEX® arms add suffix K and \$262
Dynamic load tested to 500 lbs per chair



DIGNITY2 Behavioral Health Series

Standard Features

- Separate seat and back
- Arm caps available in wood, or polyurethane
- Laminate or upholstered side panels on inside and outside of arm in various combinations
- Upholstered side panels can match or contrast seat/back
- Select from 15 standard laminates or choose any standard Wilsonart, Nevamar, Formica, Arborite and Pionite matte finish laminates at no upcharge.
- Sculpted steel leg in any Spectone finish
- No protruding legs or hardware
- Tamper proof fastenings
- Non-removable steel levelling glides
- Ships assembled
- Ships 1/carton 15 cu ft

Options

- Polyurethane arm caps available in Black (B) or Taupe RAL 7006 (T) or Sterling Grey (G)
- For wood arm caps, select from 9 standard stains, or stain-to-match at no upcharge
- KYDEX® arm caps available in Black (B) or Taupe RAL 7006 (T) or Sterling Grey (G)
- Thermofoil side panels on inside and outside of arm, call Customer Service for pricing and finishes
- Add up to 20 lbs of additional weight per seat, add \$162 List per seat
- Non-standard laminates, contact Spec for pricing
- Antibacterial and antimicrobial fabrics available
- Floor mounting straps available, call Customer Service
- Connecting and freestanding tables
- CAL 133
- Elimination of separated seat and back available with either solid or perforated seat pan, call Customer Service

Contact Spec Customer Service to railroad fabrics (specify repeat info and yardage requirement will be provided) and for repeats greater than 5" x 5"

Two Seater with no arms

COM 3.5 yds
0.75 yd COM per single seat / 1.0 yd COM per single back

| MODEL | COM | GR 1 | GR 2 | GR 3 | GR 4 | GR 5 | GR 6 |
|-------------------|-------------|-------------|-------------|-------------|-------------|-------------|-------------|
| 4602M-LL-N | 2142 | 2328 | 2388 | 2510 | 2690 | 2829 | 3012 |

Side panel – laminated, outside and inside
CAL 133, add \$240 List per two seater



4602M-N
144 lbs

COM 4.5 yds
0.75 yd COM per single seat / 1.0 yd COM per single back / .5 yd COM per panel

| MODEL | COM | GR 1 | GR 2 | GR 3 | GR 4 | GR 5 | GR 6 |
|-------------------|-------------|-------------|-------------|-------------|-------------|-------------|-------------|
| 4602M-LU-N | 2259 | 2496 | 2573 | 2729 | 2964 | 3142 | 3378 |

Side panel – laminated, outside, upholstered inside
CAL 133, add \$324 List per two seater

COM 4.5 yds
0.75 yd COM per single seat / 1.0 yd COM per single back / .5 yd COM per panel

| MODEL | COM | GR 1 | GR 2 | GR 3 | GR 4 | GR 5 | GR 6 |
|-------------------|-------------|-------------|-------------|-------------|-------------|-------------|-------------|
| 4602M-UL-N | 2259 | 2496 | 2573 | 2729 | 2964 | 3142 | 3378 |

Side panel – upholstered outside, laminated inside
CAL 133, add \$324 List per two seater

COM 5.5 yds
0.75 yd COM per single seat / 1.0 yd COM per single back / 1.0 yd COM per panel

| MODEL | COM | GR 1 | GR 2 | GR 3 | GR 4 | GR 5 | GR 6 |
|-------------------|-------------|-------------|-------------|-------------|-------------|-------------|-------------|
| 4602M-UU-N | 2375 | 2666 | 2759 | 2952 | 3236 | 3453 | 3744 |

Side panel – upholstered, outside and inside
CAL 133, add \$408 List per two seater

Dimensions (inches)

| | | | | | |
|---------|-------|---------|------|-------|------|
| seat H | 18.0 | seat W | 45.0 | arm H | 17.5 |
| total H | 31.75 | total W | 51.0 | depth | 30.0 |

For KYDEX® arms add suffix K and \$262
Dynamic load tested to 750 lbs per two seater



DIGNITY2 Behavioral Health Series

Standard Features

- Separate seat and back
- Arm caps available in wood, or polyurethane
- Laminate or upholstered side panels on inside and outside of arm in various combinations
- Upholstered side panels can match or contrast seat/back
- Select from 15 standard laminates or choose any standard Wilsonart, Nevamar, Formica, Arborite and Pionite matte finish laminates at no upcharge.
- Sculpted steel leg in any Spectone finish
- No protruding legs or hardware
- Tamper proof fastenings
- Non-removable steel levelling glides
- Ships assembled
- Ships 1/carton 15 cu ft

Options

- Polyurethane arm caps available in Black (B) or Taupe RAL 7006 (T) or Sterling Grey (G)
- For wood arm caps, select from 9 standard stains, or stain-to-match at no upcharge
- KYDEX® arm caps available in Black (B) or Taupe RAL 7006 (T) or Sterling Grey (G)
- Thermofoil side panels on inside and outside of arm, call Customer Service for pricing and finishes
- Add up to 20 lbs of additional weight per seat, add \$162 List per seat
- Non-standard laminates, contact Spec for pricing
- Antibacterial and antimicrobial fabrics available
- Floor mounting straps available, call Customer Service
- Connecting and freestanding tables
- CAL 133
- Elimination of separated seat and back available with either solid or perforated seat pan, call Customer Service

Contact Spec Customer Service to railroad fabrics (specify repeat info and yardage requirement will be provided) and for repeats greater than 5" x 5"

Three Seater with no arms

COM 5.25 yds
0.75 yd COM per single seat / 1.0 yd COM per single back

| MODEL | COM | GR 1 | GR 2 | GR 3 | GR 4 | GR 5 | GR 6 |
|-------------------|-------------|-------------|-------------|-------------|-------------|-------------|-------------|
| 4603M-LL-N | 2834 | 3111 | 3202 | 3385 | 3658 | 3864 | 4139 |

Side panel – laminated, outside and inside
CAL 133, add \$360 List per three seater

COM 6.25 yds
0.75 yd COM per single seat / 1.0 yd COM per single back / .5 yd COM per panel

| MODEL | COM | GR 1 | GR 2 | GR 3 | GR 4 | GR 5 | GR 6 |
|-------------------|-------------|-------------|-------------|-------------|-------------|-------------|-------------|
| 4603M-LU-N | 2950 | 3279 | 3387 | 3606 | 3931 | 4175 | 4503 |

Side panel – laminated, outside, upholstered inside
CAL 133, add \$444 List per three seater

COM 6.25 yds
0.75 yd COM per single seat / 1.0 yd COM per single back / .5 yd COM per panel

| MODEL | COM | GR 1 | GR 2 | GR 3 | GR 4 | GR 5 | GR 6 |
|-------------------|-------------|-------------|-------------|-------------|-------------|-------------|-------------|
| 4603M-UL-N | 2950 | 3279 | 3387 | 3606 | 3931 | 4175 | 4503 |

Side panel – upholstered outside, laminated inside
CAL 133, add \$444 List per three seater

COM 7.25 yds
0.75 yd COM per single seat / 1.0 yd COM per single back / 1.0 yd COM per panel

| MODEL | COM | GR 1 | GR 2 | GR 3 | GR 4 | GR 5 | GR 6 |
|-------------------|-------------|-------------|-------------|-------------|-------------|-------------|-------------|
| 4603M-UU-N | 3066 | 3449 | 3571 | 3826 | 4202 | 4488 | 4868 |

Side panel – upholstered, outside and inside
CAL 133, add \$528 List per three seater

Dimensions (inches)

| | | | | | |
|---------|-------|---------|------|-------|------|
| seat H | 18.0 | seat W | 68.0 | arm H | 17.5 |
| total H | 31.75 | total W | 74.0 | depth | 30.0 |

For KYDEX® arms add suffix K and \$262
Dynamic load tested to 1000 lbs per three seater



4603M-N
199 lbs



DIGNITY2 Behavioral Health Series

Standard Features

- Separate seat and back
- Arm caps available in wood, or polyurethane
- Laminate or upholstered side panels on inside and outside of arm in various combinations
- Upholstered side panels can match or contrast seat/back
- Select from 15 standard laminates or choose any standard Wilsonart, Nevamar, Formica, Arborite and Pionite matte finish laminates at no upcharge.
- Sculpted steel leg in any Spectone finish
- No protruding legs or hardware
- Tamper proof fastenings
- Non-removable steel levelling glides
- Ships assembled
- Ships 1/carton 15 cu ft

Options

- Polyurethane arm caps available in Black (B) or Taupe RAL 7006 (T) or Sterling Grey (G)
- For wood arm caps, select from 9 standard stains, or stain-to-match at no upcharge
- KYDEX® arm caps available in Black (B) or Taupe RAL 7006 (T) or Sterling Grey (G)
- Thermofoil side panels on inside and outside of arm, call Customer Service for pricing and finishes
- Add up to 20 lbs of additional weight per seat, add \$162 List per seat
- Non-standard laminates, contact Spec for pricing
- Antibacterial and antimicrobial fabrics available
- Floor mounting straps available, call Customer Service
- Connecting and freestanding tables
- CAL 133
- Elimination of separated seat and back available with either solid or perforated seat pan, call Customer Service

Contact Spec Customer Service to railroad fabrics (specify repeat info and yardage requirement will be provided) and for repeats greater than 5" x 5"

Bariatric Single Seater with no arms

COM 3.25 yds

1.5 yd COM per single seat / 1.75 yd COM per single back

| MODEL | COM | GR 1 | GR 2 | GR 3 | GR 4 | GR 5 | GR 6 |
|-------------------|-------------|-------------|-------------|-------------|-------------|-------------|-------------|
| 4601G-LL-N | 1887 | 2058 | 2112 | 2226 | 2395 | 2523 | 2693 |

Side panel – laminated, outside and inside

CAL 133, add \$154 List per chair



4601G-N
108 lbs

COM 4.25 yds

1.5 yd COM per single seat / 1.75 yd COM per single back / .5 yd COM per panel

| MODEL | COM | GR 1 | GR 2 | GR 3 | GR 4 | GR 5 | GR 6 |
|-------------------|-------------|-------------|-------------|-------------|-------------|-------------|-------------|
| 4601G-LU-N | 2002 | 2226 | 2297 | 2445 | 2668 | 2833 | 3058 |

Side panel – laminated, outside, upholstered inside

CAL 133, add \$233 List per chair

COM 4.25 yds

1.5 yd COM per single seat / 1.75 yd COM per single back / .5 yd COM per panel

| MODEL | COM | GR 1 | GR 2 | GR 3 | GR 4 | GR 5 | GR 6 |
|-------------------|-------------|-------------|-------------|-------------|-------------|-------------|-------------|
| 4601G-UL-N | 2002 | 2226 | 2297 | 2445 | 2668 | 2833 | 3058 |

Side panel – upholstered outside, laminated inside

CAL 133, add \$233 List per chair

COM 5.25 yds

1.5 yd COM per single seat / 1.75 yd COM per single back / 1.0 yd COM per panel

| MODEL | COM | GR 1 | GR 2 | GR 3 | GR 4 | GR 5 | GR 6 |
|-------------------|-------------|-------------|-------------|-------------|-------------|-------------|-------------|
| 4601G-UU-N | 2118 | 2394 | 2485 | 2668 | 2941 | 3147 | 3424 |

Side panel – upholstered, outside and inside

CAL 133, add \$312 List per chair

Dimensions (inches)

| | | | | | |
|---------|-------|---------|------|-------|------|
| seat H | 18.0 | seat W | 31.0 | arm H | 17.5 |
| total H | 31.75 | total W | 36.5 | depth | 30.0 |

For KYDEX® arms add suffix K and \$262
Dynamic load tested to 750 lbs per chair



DIGNITY2 Behavioral Health Series

Standard Features

- Separate seat and back
- Arm caps available in wood, or polyurethane
- Laminate or upholstered side panels on inside and outside of arm in various combinations
- Upholstered side panels can match or contrast seat/back
- Select from 15 standard laminates or choose any standard Wilsonart, Nevamar, Formica, Arborite and Pionite matte finish laminates at no upcharge.
- Sculpted steel leg in any Spectone finish
- No protruding legs or hardware
- Tamper proof fastenings
- Non-removable steel levelling glides
- Ships assembled
- Ships 1/carton 15 cu ft

Options

- Polyurethane arm caps available in Black (B) or Taupe RAL 7006 (T) or Sterling Grey (G)
- For wood arm caps, select from 9 standard stains, or stain-to-match at no upcharge
- KYDEX® end and polyurethane middle arm caps available in Black (B), Taupe RAL 7006 (T), or Sterling Grey (G).
- Thermofoil side panels on inside and outside of arm, call Customer Service for pricing and finishes
- Add up to 20 lbs of additional weight per seat, add \$162 List per seat
- Non-standard laminates, contact Spec for pricing
- Antibacterial and antimicrobial fabrics available
- Floor mounting straps available, call Customer Service
- Connecting and freestanding tables
- CAL 133
- Elimination of separated seat and back available with either solid or perforated seat pan, call Customer Service

Contact Spec Customer Service to railroad fabrics (specify repeat info and yardage requirement will be provided) and for repeats greater than 5" x 5"

Two Seater with half arms

COM 3.5 yds
0.75 yd COM per single seat / 1.0 yd COM per single back

| MODEL | COM | GR 1 | GR 2 | GR 3 | GR 4 | GR 5 | GR 6 |
|-----------------|-------------|-------------|-------------|-------------|-------------|-------------|-------------|
| 4612M-LL | 2582 | 2768 | 2830 | 2950 | 3134 | 3271 | 3454 |

Side panel – laminated, outside and inside
CAL 133, add \$240 List per two seater



4612M
153 lbs

COM 5.0 yds
0.75 yd COM per single seat / 1.0 yd COM per single back / .5 yd COM per panel

| MODEL | COM | GR 1 | GR 2 | GR 3 | GR 4 | GR 5 | GR 6 |
|-----------------|-------------|-------------|-------------|-------------|-------------|-------------|-------------|
| 4612M-LU | 2699 | 2961 | 3050 | 3223 | 3486 | 3680 | 3942 |

Side panel – laminated outside, upholstered inside, half arms will be upholstered
CAL 133, add \$576 List per two seater

COM 4.5 yds
0.75 yd COM per single seat / 1.0 yd COM per single back / .5 yd COM per panel

| MODEL | COM | GR 1 | GR 2 | GR 3 | GR 4 | GR 5 | GR 6 |
|-----------------|-------------|-------------|-------------|-------------|-------------|-------------|-------------|
| 4612M-UL | 2699 | 2961 | 3050 | 3223 | 3486 | 3680 | 3942 |

Side panel – upholstered outside, laminated inside, half arms will be laminated
CAL 133, add \$576 List per two seater

COM 6.0 yds
0.75 yd COM per single seat / 1.0 yd COM per single back / 1.0 yd COM per panel

| MODEL | COM | GR 1 | GR 2 | GR 3 | GR 4 | GR 5 | GR 6 |
|-----------------|-------------|-------------|-------------|-------------|-------------|-------------|-------------|
| 4612M-UU | 2816 | 3129 | 3236 | 3443 | 3758 | 3993 | 4307 |

Side panel – upholstered, outside and inside
CAL 133, add \$828 List per two seater

Dimensions (inches)

| | | | | | |
|---------|-------|---------|------|-------|------|
| seat H | 18.0 | seat W | 48.0 | arm H | 26.0 |
| total H | 31.75 | total W | 54.0 | depth | 30.0 |

For KYDEX® arms add suffix K and \$393
Dynamic load tested to 750 lbs per two seater



DIGNITY2 Behavioral Health Series

Standard Features

- Separate seat and back
- Arm caps available in wood, or polyurethane
- Laminate or upholstered side panels on inside and outside of arm in various combinations
- Upholstered side panels can match or contrast seat/back
- Select from 15 standard laminates or choose any standard Wilsonart, Nevamar, Formica, Arborite and Pionite matte finish laminates at no upcharge.
- Sculpted steel leg in any Spectone finish
- No protruding legs or hardware
- Tamper proof fastenings
- Non-removable steel levelling glides
- Ships assembled
- Ships 1/carton 15 cu ft

Options

- Polyurethane arm caps available in Black (B) or Taupe RAL 7006 (T) or Sterling Grey (G)
- For wood arm caps, select from 9 standard stains, or stain-to-match at no upcharge
- KYDEX® end and polyurethane middle arm caps available in Black (B), Taupe RAL 7006 (T), or Sterling Grey (G).
- Thermofoil side panels on inside and outside of arm, call Customer Service for pricing and finishes
- Add up to 20 lbs of additional weight per seat, add \$162 List per seat
- Non-standard laminates, contact Spec for pricing
- Antibacterial and antimicrobial fabrics available
- Floor mounting straps available, call Customer Service
- Connecting and freestanding tables
- CAL 133
- Elimination of separated seat and back available with either solid or perforated seat pan, call Customer Service

Contact Spec Customer Service to railroad fabrics (specify repeat info and yardage requirement will be provided) and for repeats greater than 5" x 5"

Three Seater with half arms

COM 5.25 yds
0.75 yd COM per single seat / 1.0 yd COM per single back

| MODEL | COM | GR 1 | GR 2 | GR 3 | GR 4 | GR 5 | GR 6 |
|-----------------|-------------|-------------|-------------|-------------|-------------|-------------|-------------|
| 4613M-LL | 3692 | 3968 | 4061 | 4243 | 4518 | 4722 | 4997 |

Side panel – laminated, outside and inside
CAL 133, add \$360 List per three seater

COM 7.25 yds
0.75 yd COM per single seat / 1.0 yd COM per single back / .5 yd COM per panel

| MODEL | COM | GR 1 | GR 2 | GR 3 | GR 4 | GR 5 | GR 6 |
|-----------------|-------------|-------------|-------------|-------------|-------------|-------------|-------------|
| 4613M-LU | 3808 | 4188 | 4317 | 4569 | 4948 | 5230 | 5611 |

Side panel – laminated outside, upholstered inside, half arms will be upholstered
CAL 133, add \$780 List per three seater



4613M
209 lbs

COM 6.25 yds
0.75 yd COM per single seat / 1.0 yd COM per single back / .5 yd COM per panel

| MODEL | COM | GR 1 | GR 2 | GR 3 | GR 4 | GR 5 | GR 6 |
|-----------------|-------------|-------------|-------------|-------------|-------------|-------------|-------------|
| 4613M-UL | 3808 | 4188 | 4317 | 4569 | 4948 | 5230 | 5611 |

Side panel – upholstered outside, laminated inside, half arms will be laminated
CAL 133, add \$780 List per three seater

COM 8.25 yds
0.75 yd COM per single seat / 1.0 yd COM per single back / 1.0 yd COM per panel

| MODEL | COM | GR 1 | GR 2 | GR 3 | GR 4 | GR 5 | GR 6 |
|-----------------|-------------|-------------|-------------|-------------|-------------|-------------|-------------|
| 4613M-UU | 3924 | 4357 | 4503 | 4789 | 5221 | 5541 | 5974 |

Side panel – upholstered, outside and inside
CAL 133, add \$1032 List per three seater

Dimensions (inches)

| | | | | | |
|---------|-------|---------|------|-------|------|
| seat H | 18.0 | seat W | 75.0 | arm H | 26.0 |
| total H | 31.75 | total W | 80.5 | depth | 30.0 |

For KYDEX® arms add suffix K and \$524
Dynamic load tested to 1000 lbs per three seater



DIGNITY2 Behavioral Health Series

Standard Features

- Tamper proof fastenings

To order full panel side panels, add ZC-LL, or ZC-U to model number, e.g. 4601M-ZC-LL

To order wall-saving side panels, add WS-LL or WS-U to the model number, e.g. 4601M-WS-U

Pricing is for entire chair (2 end side panels).

Contact Spec Customer Service to railroad fabrics (specify repeat info and yardage requirement will be provided) and for repeats greater than 5" x 5"

Options

- Thermofoil side panels on inside and outside of arm, call Customer Service for pricing and finishes
- Floor mounting straps available, call Customer Service

Extended Side Panels

Laminate Panels Inside & Outside

| MODEL | LIST |
|-------|------|
| ZC-LL | 85 |

Laminate & Upholstered Combination Panels

COM 0.5 yd per panel

| MODEL | COM | GR 1 | GR 2 | GR 3 | GR 4 | GR 5 | GR 6 |
|-------|-----|------|------|------|------|------|------|
| ZC-LU | 85 | 96 | 99 | 105 | 114 | 122 | 132 |
| ZC-UL | 85 | 96 | 99 | 105 | 114 | 122 | 132 |

Fully Upholstered Panels

COM 1.5 yd per panel

| MODEL | COM | GR 1 | GR 2 | GR 3 | GR 4 | GR 5 | GR 6 |
|-------|-----|------|------|------|------|------|------|
| ZC-U | 85 | 96 | 99 | 105 | 114 | 122 | 132 |



Side panel extended to floor

Wall-Saving Side Panels

Laminate Panels Inside & Outside

| MODEL | LIST |
|-------|------|
| WS-LL | 138 |

Laminate & Upholstered Combination Panels

COM 1.0 yd per panel

| MODEL | COM | GR 1 | GR 2 | GR 3 | GR 4 | GR 5 | GR 6 |
|-------|-----|------|------|------|------|------|------|
| WS-LU | 138 | 269 | 305 | 367 | 476 | 555 | 634 |
| WS-UL | 138 | 269 | 305 | 367 | 476 | 555 | 634 |

Fully Upholstered Panels

COM 2.0 yd per panel

| MODEL | COM | GR 1 | GR 2 | GR 3 | GR 4 | GR 5 | GR 6 |
|-------|-----|------|------|------|------|------|------|
| WS-U | 138 | 269 | 305 | 367 | 476 | 555 | 634 |



Wall-saving side panels

DIGNITY2 Behavioral Health Series

Standard Features

- Tops in laminate or veneer
- Select from 15 standard laminates or choose any standard Wilsonart, Nevamar, Formica, Arborite and Pionite matte finish laminates at no upcharge.
- Laminate tops with PVC Flat (PVF), Self Edge (SE), or hardwood (HB) edge
- 9 standard veneer and hardwood edge stains. Stain-to-match available at no upcharge.
- Tops utilize NU Green earth friendly core
- 18" height
- Non-removable steel levelling glides

Options

- Additional weight can be added, contact factory
- Non-standard laminates, contact Spec for pricing
- Floor mounting straps available, call Customer Service

Radius Corner Tables are recommended for open areas

Freestanding Lounge Tables

| Model | Laminate PVF/SE Edge | Laminate HB Edge | Veneer HB Edge | Weight | Cu.Ft. |
|--------------------|----------------------|------------------|----------------|--------|--------|
| DIGN2 - 24 x 24 SQ | 1221 | 1418 | 1455 | 62 | 7.2 |
| DIGN2 - 30 x 30 SQ | 1376 | 1518 | 1569 | 80 | 13.5 |
| DIGN2 - 36 x 36 SQ | 1503 | 1725 | 1787 | 101 | 18 |
| DIGN2 - 42 x 42 SQ | 1826 | 2149 | 2247 | 124 | 24.5 |
| DIGN2 - 48 x 48 SQ | 2023 | 2306 | 2411 | 151 | 32 |
| DIGN2 - 24 DIA | 1191 | 1550 | 1588 | 49 | 7.2 |
| DIGN2 - 30 DIA | 1343 | 1695 | 1744 | 61 | 13.5 |
| DIGN2 - 36 DIA | 1483 | 1998 | 2085 | 76 | 18 |
| DIGN2 - 42 DIA | 1815 | 2388 | 2511 | 93 | 24.5 |
| DIGN2 - 48 DIA | 1877 | 2651 | 2785 | 111 | 32 |



Corner and Spacer Connecting Tables

| Model | Laminate PVF/SE | Laminate HB Edge | Veneer HB Edge | Weight | Cu.Ft. |
|---|-----------------|------------------|----------------|--------|--------|
| DIGN2RC - 28 x 28 <i>Radius Corner Table</i> | 704 | 882 | 1091 | 31 | 2 |
| DIGN2SC - 28 x 28 <i>Square Corner Table</i> | 704 | 882 | 1091 | 32 | 2 |
| DIGN2TC - 45 degree <i>Corner Table</i> | 704 | 882 | 1091 | 26 | 2 |
| DIGN2ST - 21 x 24 <i>Spacer Table</i> | 542 | 738 | 890 | 27 | 2 |

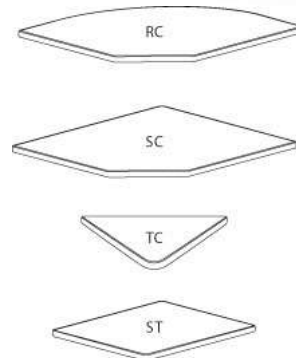

Dignity2 seating is available connected as 1, 2 and 3 seaters, with or without arms between, with corner or spacer tables. Above pricing includes connector bars.



DIGNITY2 Behavioral Health Series

Standard Features

- Black finish only
- 6" soft wheel casters
- Standard Dolly holds 1 single seat chair
- Ships 1/carton, 17 cu. ft.
- Ships assembled



Dignity2 - Dolly

| Description | Model | Price | Weight |
|-------------------|----------------|------------|--------|
| Single Seat Dolly | DIGN-99 | 557 | 12lb |

Dimensions (inches)

| | |
|--------|------|
| height | 39.0 |
| width | 23.0 |
| depth | 30.0 |





EIGHTEEN5 Nesting Series



PRODUCT CODE

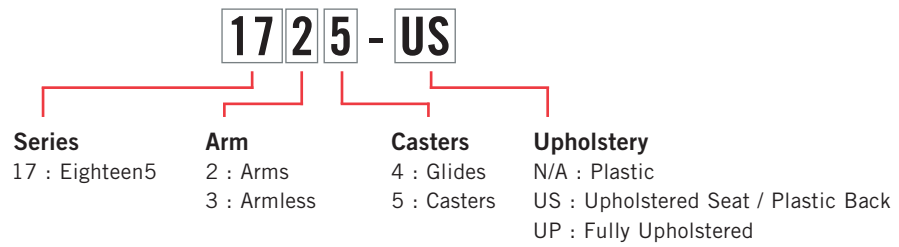

OPTIONS

UPHOLSTERY



Plastic



Upholstered Seat



Fully Upholstered

FOOT



Glide



Casters

FINISHES

FRAME



Select from one of our 76 standard Spectone colors

FABRIC



Select fabrics from one of our textile partners

PLASTIC

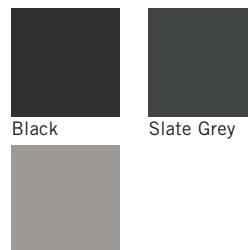

Black

Slate Grey

Light Grey

See Spectone Card or specfurniture.com/materials/finishes for a complete list of finish options and colors.



EIGHTEEN5 Nesting Series

BACK TO CONTENTS

HOW TO ORDER



Specify Model

- A** Specify Seat Type and Finish
For Upholstered Seat: Manufacturer, Pattern Name, Color
For Plastic Seat: Color
Plastic Underside: Color
- B** Specify Back Type and Finish
For Upholstered Back: Manufacturer, Pattern Name, Color
For Plastic Back: Color
- C** Specify Frame Finish

Optional: CAL 133, 1/2" Extra Foam, Soft Wheel Casters



| Model | Seat Type and Finish | Back Type and Finish | Frame Finish |
|-------|---------------------------------|----------------------|--------------|
| 1725 | Plastic, Slate Grey, Slate Grey | Plastic, Slate Grey | Silver |



EIGHTEEN5 Nesting Series

Plastic Seat and Back

Standard Features

- Plastic seat and back
- 0.875" diameter, 11 gauge frame
- Black nylon arms
- Frame in any Spectone color
- Black arms with inner steel support
- Ships 4/carton

Options

- For Soft Wheel casters, specify suffix SC and add \$20 List to the chair with casters
- Specify shell finish. Choose from Black RAL 9005, Light Grey RAL 7037 or Slate Grey RAL 7043
- CAL 133



EIGHTEEN5 – With Glides

| MODEL | PRICE |
|-------------|------------|
| 1724 | 535 |
| 1734 | 490 |

Dimensions (inches)

| | | | | | | | |
|---------|----|---------|------|-------------------|----|---------|------|
| seat H | 18 | seat W | 18.5 | seat D | 18 | arm H | 25.5 |
| total H | 32 | total W | 23.5 | total W (no arms) | 22 | total D | 21.5 |

Exceeds BIFMA Seating Durability Test to 500 lbs
CAL 133, add \$103 List



1724
With arms
18 lbs



1734
Without arms
16 lbs

EIGHTEEN5 – With Casters

| MODEL | PRICE |
|-------------|------------|
| 1725 | 535 |
| 1735 | 490 |

Dimensions (inches)

| | | | | | | | |
|---------|----|---------|------|-------------------|----|---------|------|
| seat H | 18 | seat W | 18.5 | seat D | 18 | arm H | 25.5 |
| total H | 32 | total W | 23.5 | total W (no arms) | 22 | total D | 21.5 |

Exceeds BIFMA Seating Durability Test to 500 lbs
CAL 133, add \$103 List



1725
With arms
18 lbs



1735
Without arms
16 lbs



EIGHTEEN5 Nesting Series

Upholstered Seat and Plastic Back

Standard Features

- Upholstered seat and plastic back
- 0.875" diameter, 11 gauge frame
- Black nylon arms
- Frame in any Spectone color
- Black arms with inner steel support
- Ships 4/carton

Options

- For Soft Wheel casters, specify suffix SC and add \$20 List to the chair with casters
- Specify back finish. Choose from Black RAL 9005, Light Grey RAL 7037 or Slate Grey RAL 7043
- Antibacterial and antimicrobial fabrics available
- CAL 133



Eighteen5 – With Glides

COM 0.35 yd
0.35 yd COM per single seat

| MODEL | COM | GR1 | GR2 | GR3 | GR4 | GR5 | GR6 |
|---------|-----|-----|-----|-----|-----|-----|-----|
| 1724-US | 613 | 631 | 636 | 649 | 667 | 680 | 700 |
| 1734-US | 568 | 587 | 593 | 604 | 621 | 636 | 654 |

Dimensions (inches)

| | | | | | | | |
|---------|----|---------|------|-------------------|----|---------|------|
| seat H | 18 | seat W | 18.5 | seat D | 18 | arm H | 25.5 |
| total H | 32 | total W | 23.5 | total W (no arms) | 22 | total D | 21.5 |

Exceeds BIFMA Seating Durability Test to 500 lbs
CAL 133, add \$113 List
1/2" extra seat foam, specify and add \$15 List



1724-US
With arms
22 lbs



1734-US
Without arms
19 lbs

Eighteen5 – With Casters

COM 0.35 yd
0.35 yd COM per single seat

| MODEL | COM | GR1 | GR2 | GR3 | GR4 | GR5 | GR6 |
|---------|-----|-----|-----|-----|-----|-----|-----|
| 1725-US | 613 | 631 | 636 | 649 | 667 | 680 | 700 |
| 1735-US | 568 | 587 | 593 | 604 | 621 | 636 | 654 |

Dimensions (inches)

| | | | | | | | |
|---------|----|---------|------|-------------------|----|---------|------|
| seat H | 18 | seat W | 18.5 | seat D | 18 | arm H | 25.5 |
| total H | 32 | total W | 23.5 | total W (no arms) | 22 | total D | 21.5 |

Exceeds BIFMA Seating Durability Test to 500 lbs
CAL 133, add \$113 List
1/2" extra seat foam, specify and add \$15 List



1725-US
With arms
22 lbs



1735-US
Without arms
19 lbs



EIGHTEEN5 Nesting Series

Upholstered Seat and Back

Standard Features

- Upholstered seat and back
- 0.875" diameter, 11 gauge frame
- Black nylon arms
- Frame in any Spectone color
- Black arms with inner steel support
- Ships 4/carton

Options

- For Soft Wheel casters, specify suffix SC and add \$20 List to the chair with casters
- Antibacterial and antimicrobial fabrics available
- Different fabric on seat and back at no upcharge
- CAL 133



Eighteen5 – With Glides

COM 0.7 yd
 0.35 yd COM per single seat
 0.35 yd COM per single back

| MODEL | COM | GR1 | GR2 | GR3 | GR4 | GR5 | GR6 |
|---------|-----|-----|-----|-----|-----|-----|-----|
| 1724-UP | 623 | 662 | 675 | 703 | 742 | 771 | 811 |
| 1734-UP | 579 | 617 | 631 | 657 | 698 | 725 | 765 |

Dimensions (inches)

| | | | | | | | |
|---------|----|---------|------|-------------------|----|---------|------|
| seat H | 18 | seat W | 18.5 | seat D | 18 | arm H | 25.5 |
| total H | 32 | total W | 23.5 | total W (no arms) | 22 | total D | 21.5 |

Exceeds BIFMA Seating Durability Test to 500 lbs
 CAL 133, add \$124 List
 1/2" extra seat foam, specify and add \$15 List



1724-UP
 With arms
 22 lbs



1734-UP
 Without arms
 19 lbs

Eighteen5 – With Casters

COM 0.7 yd
 0.35 yd COM per single seat
 0.35 yd COM per single back

| MODEL | COM | GR1 | GR2 | GR3 | GR4 | GR5 | GR6 |
|---------|-----|-----|-----|-----|-----|-----|-----|
| 1725-UP | 623 | 662 | 675 | 703 | 742 | 771 | 811 |
| 1735-UP | 579 | 617 | 631 | 657 | 698 | 725 | 765 |

Dimensions (inches)

| | | | | | | | |
|---------|----|---------|------|-------------------|----|---------|------|
| seat H | 18 | seat W | 18.5 | seat D | 18 | arm H | 25.5 |
| total H | 32 | total W | 23.5 | total W (no arms) | 22 | total D | 21.5 |

Exceeds BIFMA Seating Durability Test to 500 lbs
 CAL 133, add \$124 List
 1/2" extra seat foam, specify and add \$15 List



1725-UP
 With arms
 22 lbs



1735-UP
 Without arms
 19 lbs

TWENTY2 Nesting Series



PRODUCT CODE

1705 - US

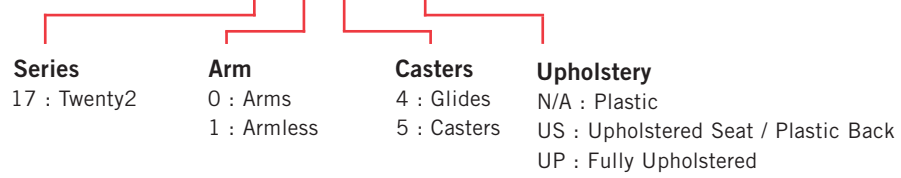

OPTIONS

UPHOLSTERY



FOOT



FINISHES

FRAME



Select from one of our 76 standard Spectone colors

FABRIC



Select fabrics from one of our textile partners

PLASTIC

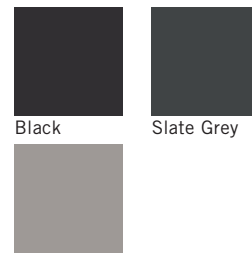

See Spectone Card or specfurniture.com/materials/finishes for a complete list of finish options and colors.



TWENTY2 Nesting Series

BACK TO CONTENTS

HOW TO ORDER



Specify Model

- A** Specify Seat Type and Finish
For Upholstered Seat: Manufacturer, Pattern Name, Color
For Plastic Seat: Color
Plastic Underside: Color
- B** Specify Back Type and Finish
For Upholstered Back: Manufacturer, Pattern Name, Color
For Plastic Back: Color
- C** Specify Frame Finish

Optional: CAL 133, 1/2" Extra Foam, Soft Wheel Casters



| Model | Seat Type and Finish | Back Type and Finish | Frame Finish |
|---------|--|----------------------|--------------|
| 1705-US | Upholstery, Momentum, Millennium, Thrill | Plastic, Black | Silver |



TWENTY2 Nesting Series

Plastic Seat and Back

Standard Features

- Plastic seat and back
- 0.875" diameter, 11 gauge frame
- Black nylon arms
- Frame in any Spectone color
- Black arms with inner steel support
- Ships 4/carton

Options

- For Soft Wheel casters, specify suffix SC and add \$20 List to the chair with casters
- Specify shell finish. Choose from Black RAL 9005, Light Grey RAL 7037 or Slate Grey RAL 7043
- CAL 133



Twenty2 – With Glides

| MODEL | PRICE |
|-------------|------------|
| 1704 | 571 |
| 1714 | 524 |

Dimensions (inches)

| | | | | | | | |
|---------|----|---------|------|-------------------|----|---------|------|
| seat H | 18 | seat W | 22 | seat D | 18 | arm H | 25.5 |
| total H | 32 | total W | 25.5 | total W (no arms) | 24 | total D | 21.5 |

Exceeds BIFMA Seating Durability Test to 500 lbs
CAL 133, add \$103 List



1704
With arms
21 lbs



1714
Without arms
19 lbs

Twenty2 – With Casters

| MODEL | PRICE |
|-------------|------------|
| 1705 | 571 |
| 1715 | 524 |

Dimensions (inches)

| | | | | | | | |
|---------|----|---------|------|-------------------|----|---------|------|
| seat H | 18 | seat W | 22 | seat D | 18 | arm H | 25.5 |
| total H | 32 | total W | 25.5 | total W (no arms) | 24 | total D | 21.5 |

Exceeds BIFMA Seating Durability Test to 500 lbs
CAL 133, add \$103 List



1705
With arms
21 lbs



1715
Without arms
19 lbs



TWENTY2 Nesting Series

Upholstered Seat and Plastic Back

Standard Features

- Upholstered seat and plastic back
- 0.875" diameter, 11 gauge frame
- Black nylon arms
- Frame in any Spectone color
- Black arms with inner steel support
- Ships 4/carton

Options

- For Soft Wheel casters, specify suffix SC and add \$20 List to the chair with casters
- Specify back finish. Choose from Black RAL 9005, Light Grey RAL 7037 or Slate Grey RAL 7043
- Antibacterial and antimicrobial fabrics available
- CAL 133



Twenty2 – With Glides

COM 0.35 yd
0.35 yd COM per single seat

| MODEL | COM | GR1 | GR2 | GR3 | GR4 | GR5 | GR6 |
|---------|-----|-----|-----|-----|-----|-----|-----|
| 1704-US | 656 | 677 | 684 | 699 | 719 | 735 | 757 |
| 1714-US | 608 | 630 | 636 | 650 | 671 | 687 | 709 |

Dimensions (inches)

| | | | | | | | |
|---------|----|---------|------|-------------------|----|---------|------|
| seat H | 18 | seat W | 22 | seat D | 18 | arm H | 25.5 |
| total H | 32 | total W | 25.5 | total W (no arms) | 24 | total D | 21.5 |

Exceeds BIFMA Seating Durability Test to 500 lbs
CAL 133, add \$113 List
1/2" extra foam, specify and add \$22 List



1704-US
With arms
23 lbs



1714-US
Without arms
21 lbs

Twenty2 – With Casters

COM 0.35 yd
0.35 yd COM per single seat

| MODEL | COM | GR1 | GR2 | GR3 | GR4 | GR5 | GR6 |
|---------|-----|-----|-----|-----|-----|-----|-----|
| 1705-US | 656 | 677 | 684 | 699 | 719 | 735 | 757 |
| 1715-US | 608 | 630 | 636 | 650 | 671 | 687 | 709 |

Dimensions (inches)

| | | | | | | | |
|---------|----|---------|------|-------------------|----|---------|------|
| seat H | 18 | seat W | 22 | seat D | 18 | arm H | 25.5 |
| total H | 32 | total W | 25.5 | total W (no arms) | 24 | total D | 21.5 |

Exceeds BIFMA Seating Durability Test to 500 lbs
CAL 133, add \$113 List
1/2" extra foam, specify and add \$22 List



1705-US
With arms
23 lbs



1715-US
Without arms
21 lbs



TWENTY2 Nesting Series

Upholstered Seat and Back

Standard Features

- Upholstered seat and back
- 0.875" diameter, 11 gauge frame
- Black nylon arms
- Frame in any Spectone color
- Black arms with inner steel support
- Ships 4/carton

Options

- For Soft Wheel casters, specify suffix SC and add \$20 List to the chair with casters
- Antibacterial and antimicrobial fabrics available
- Different fabric on seat and back at no upcharge
- CAL 133

Twenty2 – With Glides

COM 0.7 yd
 0.35 yd COM per single seat
 0.35 yd COM per single back

| MODEL | COM | GR1 | GR2 | GR3 | GR4 | GR5 | GR6 |
|---------|-----|-----|-----|-----|-----|-----|-----|
| 1704-UP | 669 | 710 | 724 | 753 | 795 | 826 | 869 |
| 1714-UP | 620 | 662 | 676 | 705 | 747 | 778 | 822 |

Dimensions (inches)

| | | | | | | | |
|---------|----|---------|------|-------------------|----|---------|------|
| seat H | 18 | seat W | 22 | seat D | 18 | arm H | 25.5 |
| total H | 32 | total W | 25.5 | total W (no arms) | 24 | total D | 21.5 |

Exceeds BIFMA Seating Durability Test to 500 lbs
 CAL 133, add \$124 List
 1/2" extra foam, specify and add \$22 List



1704-UP
 With arms
 23 lbs



1714-UP
 Without arms
 21 lbs

Twenty2 – With Casters

COM 0.7 yd
 0.35 yd COM per single seat
 0.35 yd COM per single back

| MODEL | COM | GR1 | GR2 | GR3 | GR4 | GR5 | GR6 |
|---------|-----|-----|-----|-----|-----|-----|-----|
| 1705-UP | 669 | 710 | 724 | 753 | 795 | 826 | 869 |
| 1715-UP | 620 | 662 | 676 | 705 | 747 | 778 | 822 |

Dimensions (inches)

| | | | | | | | |
|---------|----|---------|------|-------------------|----|---------|------|
| seat H | 18 | seat W | 22 | seat D | 18 | arm H | 25.5 |
| total H | 32 | total W | 25.5 | total W (no arms) | 24 | total D | 21.5 |

Exceeds BIFMA Seating Durability Test to 500 lbs
 CAL 133, add \$124 List
 1/2" extra foam, specify and add \$22 List



1705-UP
 With arms
 23 lbs



1715-UP
 Without arms
 21 lbs

ENDZONE BENCHES



PRODUCT CODE

END B3 - CCT - 20

| Series | Base | Seat-Table Specification | Depth |
|-----------------|--|--|--------------------|
| EndZone Benches | B2: Two Seats B3: Three Seats B4: Four Seats | <p><i>Two Seat Bench:</i> N/A: No Cushion Seats CC: Two Cushion Seats</p> <p><i>Three Seat Bench:</i> N/A: No Cushion Seats CCC: 3 Cushion Seats TCCT: 2 Cushion Seats Centered CCT: 2 Cushion Seats Left Aligned TCC: 2 Cushion Seats Right Aligned CTC: 1 Cushion Seat On Each End</p> <p><i>Four Seat Bench:</i> N/A: No Cushion Seats CCCC: 4 Cushion Seats TCCCT: 3 Cushion Seats Centered CCCT: 3 Cushion Seats Left Aligned TCCC: 3 Cushion Seats Right Aligned CTCC: 1 Cushion Seat Left Aligned, 2 Cushion Seats Right Aligned CCTC: 2 Cushion Seats Left Aligned, 1 Cushion Seat Right Aligned</p> | 16: 16" 20: 20" |



OPTIONS

RECTANGULAR VERTICAL WIRE MANAGER



POWER OPTION



FINISHES

LAMINATE



Select from 15 standard laminates or choose any standard Wilsonart, Nevamar, Formica, Arborite and Pionite matte finish laminates at no upcharge

FABRIC



Select fabrics from one of our textile partners

VERTICAL WIRE MANAGER

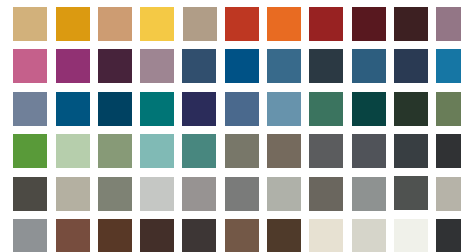

Select from one of our 76 standard Spectone colors

EDGE



2MM

See Spectone Card or specfurniture.com/materials/finishes for a complete list of finish options and colors.

ENDZONE BENCHES

HOW TO ORDER

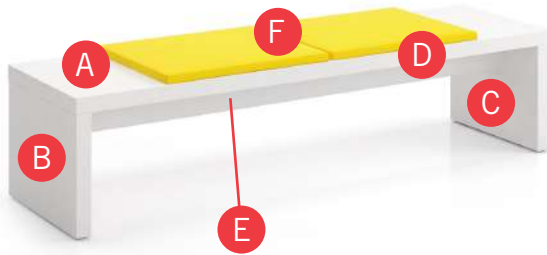

Specify Model

- A** Specify Top Surface
Manufacturer, Laminate Name, Laminate Code
- B** Specify End Panel Outside Surface
Manufacturer, Laminate Name, Laminate Code
- C** Specify End Panel Inside Surface
Manufacturer, Laminate Name, Laminate Code
- D** Specify Edge Type and Color
2mm Bio / 2mm PVC Woodgrain
- E** Specify Support Beam Finish
Manufacturer, Laminate Name, Laminate Code
- F** Specify Cushion Fabric¹
Manufacturer, Pattern Name, Color

Optional: 16" Depth, CAL 133, Moisture Barrier, Cove Mini Power Module with Vertical Wire Manager

¹ When multiple fabrics are specified please provide a drawing and legend for fabric placement. For custom cushion location, please provide drawing.



| Model | Top Surface | End Panel Outside Surface | End Panel Inside Surface | Edge Type and Color | Support Beam Finish | Cushion Fabric |
|------------|------------------------------------|------------------------------------|------------------------------------|---------------------|------------------------------------|-------------------------------------|
| ENDB3-TCCT | Wilsonart, Designer White, D354-60 | Wilsonart, Designer White, D354-60 | Wilsonart, Designer White, D354-60 | 2mm Bio, RAL 9016 | Wilsonart, Designer White, D354-60 | CF Stinson, Avant AV101, Sun Yellow |

ENDZONE BENCHES DIMENSION OVERVIEW

WHEN TABLE IS AT THE END OF THE BENCH

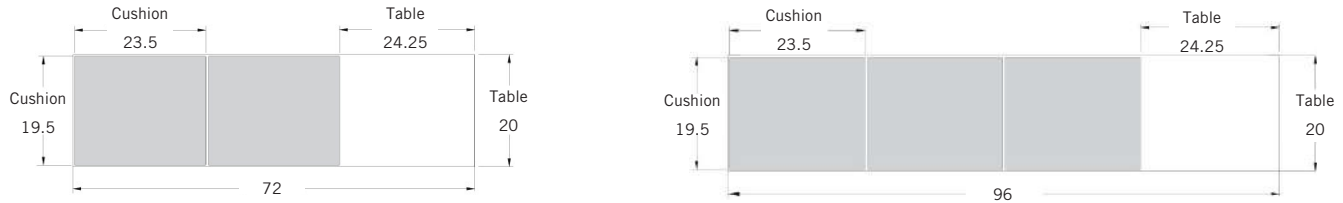

Cushion is recessed 0.25" from the outer edges of the bench. A gap between two adjacent cushions is 0.5". Same table dimensions apply on all benches.

WHEN TABLE IS IN THE MIDDLE OF THE BENCH

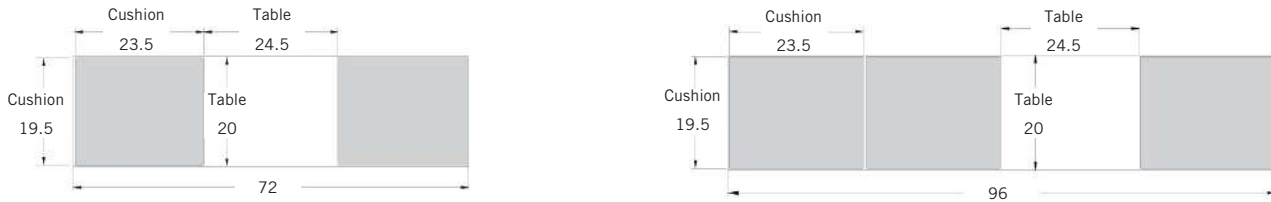

Cushion is recessed 0.25" from the outer edges of the bench. A gap between two adjacent cushions is 0.5". Same table dimensions apply on all benches.

WHEN TABLE IS ON EACH END OF THE BENCH

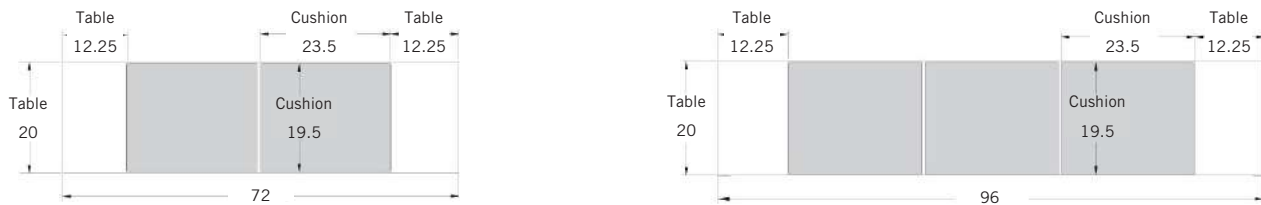

Cushion is recessed 0.25" from the outer edges of the bench. A gap between two adjacent cushions is 0.5". Same table dimensions apply on all benches.



ENDZONE BENCHES

Standard Features

- 2" built up edge
- 2mm Edge (2MM)
- Laminate Top, End Panels, and Support Beam
- Select from 15 standard laminates or choose any standard Wilsonart, Nevamar, Formica, Arborite and Pionite matte finish laminates at no upcharge. For other laminate please contact the factory for pricing.
- Adjustable Glides
- Weight load tested to 250 lbs per seat
- 20" deep

Options

- 2mm Bio edge available in 38 solid colors
- 2mm PVC edge available in wood grain to match 9 standard stains
- For 16" depth add suffix "-16" to product code
- Cove Power Modules can only be specified on the outside of the end panels - see accessories at the end of this section
- Vertical Wire Manager can only be specified on the inside of the end panels - see accessories at the end of this section
- For two different laminate colors, call factory for pricing
- Antibacterial and antimicrobial fabrics available
- If different grades of fabric specified on different cushions, use higher graded fabric price
- COM 0.75 yd per cushion
- CAL 133, add \$67 List per cushion

Contact Spec Customer Service to railroad fabrics and for repeats greater than 5" x 5"



| MODEL | DESCRIPTION | TOP SPECIFICATIONS | | | | | | DIMENSIONS | | | LBS | |
|-------------------|--------------------------|--------------------|------|------|------|------|------|------------|--------|--------|-----|--------|
| | | COM | GR1 | GR2 | GR3 | GR4 | GR5 | GR6 | H (in) | W (in) | | D (in) |
| <i>Two Seat</i> | | | | | | | | | | | | |
| ENDB2 | No Cushions | 2419 | | | | | | 17 | 48 | 20 | 74 | |
| ENDB2-CC | 2 Cushions | 2763 | 2824 | 2844 | 2886 | 2947 | 2993 | 3057 | 18 | 48 | 20 | 80 |
| <i>Three Seat</i> | | | | | | | | | | | | |
| ENDB3 | No Cushions | 2842 | | | | | | | 17 | 72 | 20 | 96 |
| ENDB3-CCC | 3 Cushions | 3360 | 3451 | 3480 | 3542 | 3634 | 3704 | 3797 | 18 | 72 | 20 | 105 |
| ENDB3-TCCT | 2 Cushions Centered | 3187 | 3248 | 3268 | 3309 | 3370 | 3417 | 3479 | 18 | 72 | 20 | 102 |
| ENDB3-CCT | 2 Cushions Left Aligned | 3187 | 3248 | 3268 | 3309 | 3370 | 3417 | 3479 | 18 | 72 | 20 | 102 |
| ENDB3-TCC | 2 Cushions Right Aligned | 3187 | 3248 | 3268 | 3309 | 3370 | 3417 | 3479 | 18 | 72 | 20 | 102 |
| ENDB3-CTC | Cushion Seat on Each End | 3187 | 3248 | 3268 | 3309 | 3370 | 3417 | 3479 | 18 | 72 | 20 | 102 |



ENDZONE BENCHES

Standard Features

- 2" built up edge
- 2mm Edge (2MM)
- Laminate Top, End Panels, and Support Beam
- Select from 15 standard laminates or choose any standard Wilsonart, Nevamar, Formica, Arborite and Pionite matte finish laminates at no upcharge. For other laminate please contact the factory for pricing.
- Adjustable Glides
- Weight load tested to 250 lbs per seat
- 20" deep

Options

- 2mm Bio edge available in 38 solid colors
- 2mm PVC edge available in wood grain to match 9 standard stains
- For 16" depth add suffix "-16" to product code
- Cove Power Modules can only be specified on the outside of the end panels - see accessories at the end of this section
- Vertical Wire Manager can only be specified on the inside of the end panels - see accessories at the end of this section
- For two different laminate colors, call factory for pricing
- Antibacterial and antimicrobial fabrics available
- If different grades of fabric specified on different cushions, use higher graded fabric price
- COM 0.75 yd per cushion
- CAL 133, add \$67 List per cushion

Contact Spec Customer Service to railroad fabrics and for repeats greater than 5" x 5"





| MODEL | DESCRIPTION | TOP SPECIFICATIONS | | | | | | DIMENSIONS | | | LBS | |
|------------------|---|--------------------|------|------|------|------|------|------------|--------|--------|-----|--------|
| | | COM | GR1 | GR2 | GR3 | GR4 | GR5 | GR6 | H (in) | W (in) | | D (in) |
| <i>Four Seat</i> | | | | | | | | | | | | |
| ENDB4 | No Cushions | 3333 | | | | | | | 17 | 96 | 20 | 118 |
| ENDB4-CCCC | 4 Cushions | 4024 | 4144 | 4184 | 4266 | 4390 | 4483 | 4607 | 18 | 96 | 20 | 130 |
| ENDB4-TCCCT | 3 Cushions Centered | 3851 | 3942 | 3972 | 4034 | 4126 | 4196 | 4289 | 18 | 96 | 20 | 127 |
| ENDB4-CCCT | 3 Cushions Left Aligned | 3851 | 3942 | 3972 | 4034 | 4126 | 4196 | 4289 | 18 | 96 | 20 | 127 |
| ENDB4-TCCC | 3 Cushions Right Aligned | 3851 | 3942 | 3972 | 4034 | 4126 | 4196 | 4289 | 18 | 96 | 20 | 127 |
| ENDB4-CTCC | 1 Cushion Left Aligned, 2 Cushions Right Aligned | 3851 | 3942 | 3972 | 4034 | 4126 | 4196 | 4289 | 18 | 96 | 20 | 127 |
| ENDB4-CCTC | 2 Cushions Left Aligned, 1 Cushion Right Aligned | 3851 | 3942 | 3972 | 4034 | 4126 | 4196 | 4289 | 18 | 96 | 20 | 127 |

ENDZONE BENCHES

POWER & COMMUNICATION

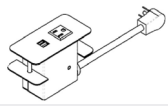
Cove Power Modules

| | MODEL | DESCRIPTION | LIST | |
|---|-----------------|--|------|---|
|  | COV-1U-B | Cove, Clamp Mounted Cove, 1 power, 2USB, Black | 390 |  |
| | COV-1U-S | Cove, 1 power, 2USB, Silver Pearl | 390 | |
| | COV-1U-W | Cove, 1 power, 2USB, Gloss White | 390 | |
| | | <i>Cord is 108". USB is for charging only.</i> | | |
|  | RVWM-L | Rectangular Vertical Wire Manager for EndZone Benches | 165 | |
| | RVWM-R | Fixed sheet metal cover. Specify placement on the inside of the left (RVWM-L) and/or right (RVWM-R) end panel as viewed from the front. | 165 | |



GRAVITY Public Seating

LAYOUTS



Description

- Spec's Gravity Public Seating offers specifiers outstanding value in an eco-friendly design.
- Your layout possibilities are unlimited with spacer, radius and corner tables – for both standard and bariatric seating in virtually any combination.
- Bariatric seating is a 30" wide seat and is load tested to 750 lbs. Cannot be connected to other bariatric seats.
- 21" seat width is standard.
- Standard with steel arms.
- Choice of wood or black polyurethane arms at an upcharge.
- Wood and polyurethane arms are replaceable in the field.
- All models offer a choice of no center arms, half arms or full arms to the floor.
- Glides and separate seat and Flex Back are standard.
- Please send a drawing of the configuration you require with your order.
- For fabrics you wish railroaded or repeats larger than 5" x 5", please contact the factory with repeat information and yardage requirement will be provided.



LAYOUTS AND DIMENSIONS

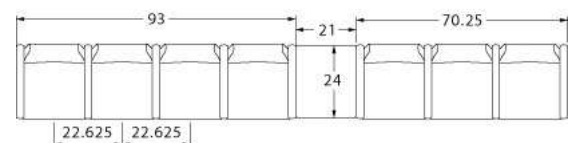
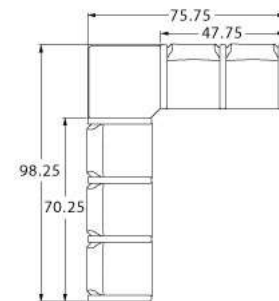
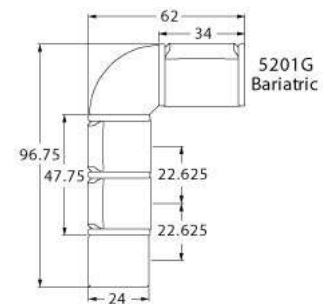



GRAVITY Public Seating



PRODUCT CODE

52 2 1 M

| Series | Center Arm | # Seats | Chair Type |
|--------------|--|---|---|
| 52 : Gravity | 0 : Outside Arms 1 : Half Arms 2 : Full Arms | 1 : Single Seat 2 : Two-Seat 3 : Three-Seat | M : Mid Back H : Highback G : Bariatric |

OPTIONS

ARM TYPE



Polyurethane



Wood



Steel

FINISHES

FRAME



Select from one of our 76 standard Spectone colors

FABRIC



Select fabrics from one of our textile partners

ARMS



Black

Sterling Grey

Taupe

Select from one of our 9 standard wood stains or stain-to-match at no upcharge

See Spectone Card or specfurniture.com/materials/finishes for a complete list of finish options and colors.

GRAVITY Public Seating

HOW TO ORDER



Specify Model

- A** Specify Fabric - Seat¹
Manufacturer, Pattern Name, Color
- B** Specify Fabric - Back¹
Manufacturer, Pattern Name, Color
- C** Specify Frame Finish

Optional: Wood or Polyurethane Arms, CAL 133, Moisture Barrier, Connecting and Freestanding Tables

¹ When multiple fabrics are specified on two and three seat chairs, please provide a drawing and legend for fabric placement.

Shown with optional Polyurethane arm.

| Model | Fabric - Seat | Fabric - Back | Frame Finish | Arm Type and Color |
|-------|---------------------------|---------------------------|--------------|---------------------|
| 5201M | Momentum, Beeline, Canvas | Momentum, Beeline, Canvas | Silver | Polyurethane, Black |





GRAVITY Public Seating

Single Seater with arms

Standard Features

- Separate seat and Flex Back
- Steel arms
- Fully welded wall-saving frame
- Frame in any Spectone color
- Velcro removable back covers
- Replaceable seats
- Use in connected layouts at no upcharge
- Glides
- Ships assembled
- Ships 1/carton 15 cu ft

Options

- Field-replaceable polyurethane arms (P) available in Black, Sterling Grey and Taupe (RAL 7006), add \$110 List
- Field-replaceable wood arms (W) in Natural Maple, add \$158 List. Available in any of 9 standard stains or stain-to-match at no upcharge
- Connected and freestanding tables
- Antibacterial and antimicrobial fabrics available
- Different fabric on seat and back at no upcharge
- CAL 133

Contact Spec Customer Service to railroad fabrics (specify repeat info and yardage requirement will be provided) and for repeats greater than 5" x 5"



Single Seater with arms

COM 1.75 yds
 0.75 yd COM per single seat
 1.0 yd COM per single back

| MODEL | COM | GR 1 | GR 2 | GR 3 | GR 4 | GR 5 | GR 6 |
|--------------|------------|------------|------------|-------------|-------------|-------------|-------------|
| 5201M | 831 | 922 | 951 | 1013 | 1101 | 1171 | 1263 |

Dimensions (inches)

| | | | | | |
|---------|-------|---------|------|-------|------|
| seat H | 18.0 | seat W | 21.0 | arm H | 26.5 |
| total H | 35.75 | total W | 25.0 | depth | 27.5 |

Exceeds BIFMA Seating Durability Test to 500 lbs per chair
 CAL 133, add \$120 List per chair



5201M*
39 lbs

*Shown with optional polyurethane arms



GRAVITY Public Seating

Two and Three Seaters with outside arms

Standard Features

- Separate seat and Flex Back
- Steel arms
- Fully welded wall-saving frame
- Frame in any Spectone color
- Velcro removable back covers
- Replaceable seats
- Use in connected layouts at no upcharge
- Glides
- Ships assembled
- Ships 1/carton 26 cu ft (2 seater),
1/carton 39 cu ft (3 seater)

Options

- Field-replaceable polyurethane arms (P) available in Black, Sterling Grey and Taupe (RAL 7006), add \$110 List
- Field-replaceable wood arms (W) in Natural Maple, add \$158 List. Available in any of 9 standard stains or stain-to-match at no upcharge
- Connected and freestanding tables
- Antibacterial and antimicrobial fabrics available
- Different fabric on seat and back at no upcharge
- CAL 133

Contact Spec Customer Service to railroad fabrics (specify repeat info and yardage requirement will be provided) and for repeats greater than 5" x 5"



Two Seater with outside arms

COM 3.5 yds
0.75 yd COM per single seat
1.0 yd COM per single back

| MODEL | COM | GR 1 | GR 2 | GR 3 | GR 4 | GR 5 | GR 6 |
|--------------|-------------|-------------|-------------|-------------|-------------|-------------|-------------|
| 5202M | 1507 | 1687 | 1746 | 1870 | 2046 | 2185 | 2368 |

Dimensions (inches)

| | | | | | |
|---------|-------|---------|------|-------|------|
| seat H | 18.0 | seat W | 21.0 | arm H | 26.5 |
| total H | 35.75 | total W | 46.0 | depth | 27.5 |

Exceeds BIFMA Seating Durability Test to 500 lbs per two seater
CAL 133, add \$240 List per two seater



5202M*
65 lbs

Three Seater with outside arms

COM 5.25 yds
0.75 yd COM per single seat
1.0 yd COM per single back

| MODEL | COM | GR 1 | GR 2 | GR 3 | GR 4 | GR 5 | GR 6 |
|--------------|-------------|-------------|-------------|-------------|-------------|-------------|-------------|
| 5203M | 2193 | 2465 | 2554 | 2738 | 3006 | 3215 | 3488 |

Dimensions (inches)

| | | | | | |
|---------|-------|---------|------|-------|------|
| seat H | 18.0 | seat W | 21.0 | arm H | 26.5 |
| total H | 35.75 | total W | 67.0 | depth | 27.5 |

Exceeds BIFMA Seating Durability Test to 500 lbs per three seater
CAL 133, add \$360 List per three seater



5203M*
91 lbs

*Shown with optional polyurethane arms



GRAVITY Public Seating

Two and Three Seaters with half arms

Standard Features

- Separate seat and Flex Back
- Steel arms
- Fully welded wall-saving frame
- Frame in any Spectone color
- Velcro removable back covers
- Replaceable seats
- Use in connected layouts at no upcharge
- Glides
- Ships assembled
- Ships 1/carton 26 cu ft (2 seater),
1/carton 39 cu ft (3 seater)

Options

- Field-replaceable polyurethane arms (P) available in Black, Sterling Grey and Taupe (RAL 7006), add \$165 List for 5212M or \$220 List for 5213M
- Field-replaceable wood arms (W) in Natural Maple, add \$237 List for 5212M or \$316 List for 5213M. Available in any of 9 standard stains or stain-to-match at no upcharge
- Connected and freestanding tables
- Antibacterial and antimicrobial fabrics available
- Different fabric on seat and back at no upcharge
- CAL 133

Contact Spec Customer Service to railroad fabrics (specify repeat info and yardage requirement will be provided) and for repeats greater than 5" x 5"

Two Seater with half arms

COM 3.5 yds
0.75 yd COM per single seat
1.0 yd COM per single back

| MODEL | COM | GR 1 | GR 2 | GR 3 | GR 4 | GR 5 | GR 6 |
|-------|------|------|------|------|------|------|------|
| 5212M | 1617 | 1798 | 1856 | 1982 | 2156 | 2295 | 2477 |

Dimensions (inches)

| | | | | | |
|---------|-------|---------|-------|-------|------|
| seat H | 18.0 | seat W | 21.0 | arm H | 26.5 |
| total H | 35.75 | total W | 47.75 | depth | 27.5 |

Exceeds BIFMA Seating Durability Test to 500 lbs per two seater
CAL 133, add \$240 List per two seater



5212M*
67 lbs

Three Seater with half arms

COM 5.25 yds
0.75 yd COM per single seat
1.0 yd COM per single back

| MODEL | COM | GR 1 | GR 2 | GR 3 | GR 4 | GR 5 | GR 6 |
|-------|------|------|------|------|------|------|------|
| 5213M | 2427 | 2697 | 2786 | 2970 | 3238 | 3448 | 3719 |

Dimensions (inches)

| | | | | | |
|---------|-------|---------|-------|-------|------|
| seat H | 18.0 | seat W | 21.0 | arm H | 26.5 |
| total H | 35.75 | total W | 70.25 | depth | 27.5 |

Exceeds BIFMA Seating Durability Test to 500 lbs per two seater
CAL 133, add \$360 List per three seater



5213M*
93 lbs

*Shown with optional polyurethane arms



GRAVITY Public Seating

Two and Three Seaters with full arms

Standard Features

- Separate seat and Flex Back
- Steel arms
- Fully welded wall-saving frame
- Frame in any Spectone color
- Velcro removable back covers
- Replaceable seats
- Use in connected layouts at no upcharge
- Glides
- Ships assembled
- Ships 1/carton 26 cu ft (2 seater),
1/carton 39 cu ft (3 seater)

Options

- Field-replaceable polyurethane arms (P) available in Black, Sterling Grey and Taupe (RAL 7006), add \$165 List for 5222M or \$220 List for 5223M
- Field-replaceable wood arms (W) in Natural Maple, add \$237 List for 5222M or \$316 List for 5223M. Available in any of 9 standard stains or stain-to-match at no upcharge
- Connected and freestanding tables
- Antibacterial and antimicrobial fabrics available
- Different fabric on seat and back at no upcharge
- CAL 133

Contact Spec Customer Service to railroad fabrics (specify repeat info and yardage requirement will be provided) and for repeats greater than 5" x 5"



Two Seater with full arms

COM 3.5 yds
0.75 yd COM per single seat
1.0 yd COM per single back

| MODEL | COM | GR 1 | GR 2 | GR 3 | GR 4 | GR 5 | GR 6 |
|-------|------|------|------|------|------|------|------|
| 5222M | 1617 | 1798 | 1856 | 1982 | 2156 | 2295 | 2477 |

Dimensions (inches)

| | seat H | 18.0 | seat W | 21.0 | arm H | 26.5 |
|---------|--------|---------|--------|-------|-------|------|
| total H | 35.75 | total W | 47.75 | depth | 27.5 | |

Exceeds BIFMA Seating Durability Test to 500 lbs per two seater
CAL 133, add \$240 List per two seater



5222M*
68 lbs

Three Seater with full arms

COM 5.25 yds
0.75 yd COM per single seat
1.0 yd COM per single back

| MODEL | COM | GR 1 | GR 2 | GR 3 | GR 4 | GR 5 | GR 6 |
|-------|------|------|------|------|------|------|------|
| 5223M | 2427 | 2697 | 2786 | 2970 | 3238 | 3448 | 3719 |

Dimensions (inches)

| | seat H | 18.0 | seat W | 21.0 | arm H | 26.5 |
|---------|--------|---------|--------|-------|-------|------|
| total H | 35.75 | total W | 70.25 | depth | 27.5 | |

Exceeds BIFMA Seating Durability Test to 500 lbs per three seater
CAL 133, add \$360 List per three seater



5223M*
94 lbs

*Shown with optional polyurethane arms



GRAVITY Public Seating

Bariatric Single Seater with arms

Standard Features

- Separate seat and Flex Back
- Steel arms
- Fully welded wall-saving frame
- Frame in any Spectone color
- Velcro removable back covers
- Replaceable seats
- Use in connected layouts at no upcharge
- Glides
- Cannot connect bariatric seating to bariatric seating
- Ships assembled
- Ships 1/carton 20 cu ft

Options

- Field-replaceable polyurethane arms (P) available in Black, Sterling Grey and Taupe (RAL 7006), add \$110 List
- Field-replaceable wood arms (W) in Natural Maple, add \$158 List. Available in any of 9 standard stains or stain-to-match at no upcharge
- Connected and freestanding tables
- Antibacterial and antimicrobial fabrics available
- Different fabric on seat and back at no upcharge
- CAL 133

Contact Spec Customer Service to railroad fabrics (specify repeat info and yardage requirement will be provided) and for repeats greater than 5" x 5"



Bariatric Single Seater with arms

COM 3.0 yds
 1.5 yd COM per single seat
 1.5 yd COM per single back

| MODEL | COM | GR 1 | GR 2 | GR 3 | GR 4 | GR 5 | GR 6 |
|--------------|-------------|-------------|-------------|-------------|-------------|-------------|-------------|
| 5201G | 1034 | 1214 | 1273 | 1399 | 1574 | 1713 | 1895 |

Dimensions (inches)

| | | | | | |
|---------|-------|---------|------|-------|------|
| seat H | 18.0 | seat W | 30.0 | arm H | 26.5 |
| total H | 35.75 | total W | 34.0 | depth | 27.5 |

Exceeds BIFMA Seating Durability Test to 750 lbs per chair
 CAL 133, add \$163 List per chair



5201G*
53 lbs

*Shown with optional polyurethane arms



GRAVITY Public Seating

Highback Single Seater with arms – Ottoman and Headrest

Standard Features

- Separate seat and Flex Back
- Steel arms
- Fully welded wall-saving frame
- Frame in any Spectone color
- Velcro removable back covers
- Replaceable seats
- Use in connected layouts at no upcharge
- Glides
- Ships assembled
- Ships 1/carton 18 cu ft

Options

- Field-replaceable polyurethane arms (P) available in Black, Sterling Grey and Taupe (RAL 7006), add \$110 List
- Field-replaceable wood arms (W) in Natural Maple, add \$158 List. Available in any of 9 standard stains or stain-to-match at no upcharge
- Connected and freestanding tables
- Antibacterial and antimicrobial fabrics available
- Different fabric on seat and back at no upcharge
- CAL 133

Contact Spec Customer Service to railroad fabrics (specify repeat info and yardage requirement will be provided) and for repeats greater than 5" x 5"



Highback Single Seater with arms

COM 1.85 yds
 0.75 yd COM per single seat
 1.1 yds COM per single back

| MODEL | COM | GR 1 | GR 2 | GR 3 | GR 4 | GR 5 | GR 6 |
|--------------|------------|-------------|-------------|-------------|-------------|-------------|-------------|
| 5201H | 891 | 1000 | 1036 | 1110 | 1217 | 1300 | 1409 |

Dimensions (inches)

| | | | | | |
|---------|------|---------|------|-------|------|
| seat H | 18.0 | seat W | 21.0 | arm H | 26.5 |
| total H | 44.5 | total W | 25.0 | depth | 27.5 |

Exceeds BIFMA Seating Durability Test to 500 lbs per chair
 CAL 133, add \$127 List per chair



5201H*
42 lbs

*Shown with optional polyurethane arms

GRAVITY Public Seating

Freestanding Lounge Tables – Corner and Spacer Connecting Tables

Standard Features

- Tops in laminate or veneer
- Select laminate tops from 15 standard laminates or choose any standard Wilsonart, Nevamar, Formica, Arborite and Pionite matte finish laminates at no upcharge.
- Freestanding lounge tables available with PVC Flat (PVF), 2mm (2MM), exposed Baltic Birch plywood (PF, PKNR) or hardwood (HB) edge
- Connecting table tops available with PVC Flat (PVF) edge, Self edge (SE) or hardwood (HB) edge
- 9 standard veneer and hardwood edge stains. Stain-to-match available at no upcharge.
- 1.75" post legs in any Spectone color
- Tops utilize NU Green earth friendly core
- Glides
- 18" height

Options

- Non-standard laminates, contact Spec for pricing
- Custom size spacer tables for restricted spaces
- Other sizes may be available

Radius Corner Tables are recommended for open areas

Freestanding Lounge Tables

| Model | Laminate PVF/SE/2MM | Laminate PF/PKNR/HB | Veneer HB | Weight | Cu.Ft. |
|-----------------|------------------------|------------------------|--------------|--------|--------|
| 52 - 24 x 24 SQ | 654 | 850 | 1004 | 28 | 7.2 |
| 52 - 24 x 48 RE | 816 | 1031 | 1248 | 48 | 18 |
| 52 - 30 x 30 SQ | 761 | 903 | 1069 | 43 | 13.5 |
| 52 - 24 DIA | 623 | 984 | 1188 | 26 | 7.2 |
| 52 - 30 DIA | 727 | 1082 | 1292 | 40 | 7.2 |



Corner and Spacer Connecting Tables

| Model | Laminate PVF/SE | Laminate HB Edge | Veneer HB Edge | Weight | Cu.Ft. |
|--|--------------------|---------------------|-------------------|--------|--------|
| 52RC - 28 x 28 <i>Radius Corner Table</i> | 704 | 882 | 1091 | 26 | 2 |
| 52SC - 28 x 28 <i>Square Corner Table</i> | 704 | 882 | 1091 | 26 | 2 |
| 52TC - 45 degree <i>Corner Table</i> | 704 | 882 | 1091 | 19 | 2 |
| 52ST - 21 x 24 <i>Spacer Table</i> | 542 | 738 | 890 | 19 | 2 |
| 52ET - 21 x 24 <i>End Table</i> | 590 | 785 | 939 | 19 | 2 |

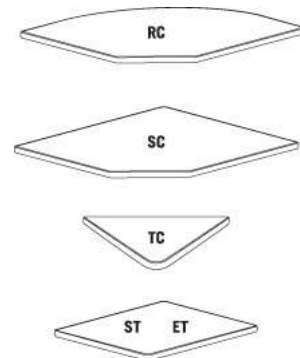



HARDI Behavioral Health Series



PRODUCT CODE

8701

Series

- 8701 : Hardi Dining, Armless
- 8702 : Hardi Children's, Dining, Armless
- 8708 : Hardi Dining, with Arms
- 8801 : Hardi Lounge, Armless
- 8808 : Hardi Lounge, with Arms
- 8840 : Hardi Rocker
- 8901 : Hardi Stool



OPTIONS

GLIDES



ADDITIONAL WEIGHT



FLOOR MOUNT



GANGING



FINISHES

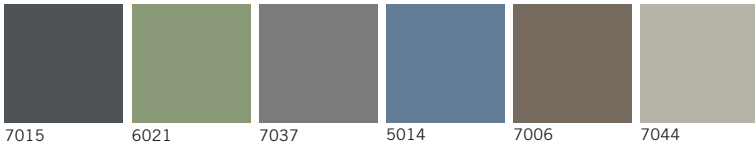

Select from 6 standard colors. Custom colors may be available based on quantity. Contact Customer Service.

HOW TO ORDER



Specify Model

A Specify Shell Color

Optional: Non-removable Glides, Ganging, Floor Mounting Straps

| Model | Shell Color |
|-------|-------------|
| 8701 | RAL 5014 |

HARDI Behavioral Health Series

For warmth, strength and sustainability

Standard Features

- Single roto-molded design
- CAL 133 compliant
- Select from 6 standard colors, which have been selected from our palette of standard Spectone finishes
- No protruding legs or hardware
- Standard without glides
- Dining ships 1/carton 14 cu ft, Lounge ships 1/carton 16 cu ft
- Removable threaded cap is fastened with tamperproof fasteners. Sand (not included) can be added on site for additional weight and ballast utilizing the plastic bag from packaging. Contact Customer Service for more information



Options

- Four nickel-plated non-removable nylon glides secured with LOCTITE®, add \$20 List
- Ganging is available. Please specify a set of nickel-plated non-removable nylon glides secured with LOCTITE for each chair that you want to gang together (\$20 List per chair), and add Q-1 ganging kits (\$36 List). In other words, to gang 9 chairs together, please order 9 sets of glides and 8 ganging kits.
- Floor mounting is available. Please specify a set of nickel-plated non-removable nylon glides secured with LOCTITE for each chair that you want to mount to the floor (\$20 List per chair), and add the same amount of floor mounting kits (\$36 List). In other words, to floor mount 9 chairs, please order 9 sets of glides and 9 floor mounting kits.

Dining

| MODEL | Price |
|-------------|------------|
| 8701 | 584 |
| 8708 | 659 |

Dimensions (inches)

| | | | | | | | |
|--------|------|-------------------|------|----------------|------|---------|------|
| seat H | 18.0 | seat W | 20.0 | arm H | 26.0 | total H | 33.0 |
| depth | 24.0 | total W (no arms) | 22.0 | total W (arms) | 24.0 | | |

Exceeds BIFMA Seating Durability Test to 500 lbs



8701
Without arms
23 lbs



8708
With arms
28 lbs

Lounge

| MODEL | Price |
|-------------|------------|
| 8801 | 631 |
| 8808 | 738 |

Dimensions (inches)

| | | | | | | | |
|--------|-------|-------------------|------|----------------|------|---------|-------|
| seat H | 17.25 | seat W | 23.0 | arm H | 25.0 | total H | 29.50 |
| depth | 27.0 | total W (no arms) | 26.0 | total W (arms) | 27.0 | | |

Exceeds BIFMA Seating Durability Test to 500 lbs



8801
Without arms
25 lbs



8808
With arms
31 lbs



HARDI Behavioral Health Series

For warmth, strength and sustainability

Standard Features

- Single roto-molded design
- CAL 133 compliant
- Select from 6 standard colors, which have been selected from our palette of standard Spectone finishes
- No protruding legs or hardware
- Rocker ships 1/carton 26 cu ft
- Removable threaded cap is fastened with tamperproof fasteners. Sand (not included) can be added on site for additional weight and ballast utilizing the plastic bag from packaging. Contact Customer Service for more information



Rocker

| MODEL | Price |
|-------------|-------------|
| 8840 | 1258 |

Dimensions (inches)

| | | | | | | | |
|--------|-------|---------|------|-------|------|---------|------|
| seat H | 18.25 | seat W | 20.0 | arm H | 25.0 | total H | 37.5 |
| depth | 33.75 | total W | 28.0 | | | | |

Exceeds BIFMA Seating Durability Test to 500 lbs



8840
36 lbs



HARDI Behavioral Health Series

For warmth, strength and sustainability

Standard Features

- Single roto-molded design
- CAL 133 compliant
- Select from 6 standard colors, which have been selected from our palette of standard Spectone finishes
- No protruding legs or hardware
- Standard without glides
- Stool ships 1/carton 4 cu ft
- Removable threaded cap is fastened with tamperproof fasteners. Sand (not included) can be added on site for additional weight and ballast utilizing the plastic bag from packaging. Contact Customer Service for more information

Options

- Nickel-plated non-removable nylon glides secured with LOCTITE®, add \$20 List
- Floor mounting is available. Please specify a set of nickel-plated non-removable nylon glides secured with LOCTITE for each stool that you want to mount to the floor (\$20 List per stool), and add the same amount of floor mounting kits (\$36 List). In other words, to floor mount 9 stools, please order 9 sets of glides and 9 floor mounting kits.



Stool

| MODEL | Price |
|-------------|------------|
| 8901 | 417 |

Dimensions (inches)

| | | | |
|---------|------|---------|------|
| seat H | 18.0 | seat W | 16.0 |
| total H | 18.0 | total W | 17.5 |

Exceeds BIFMA Seating Durability Test to 500 lbs



8901
10 lbs



HARDI CHILDREN'S Behavioral Health Series

For warmth, strength and sustainability

Standard Features

- Single roto-molded design
- Select from 6 standard colors, which have been selected from our palette of standard Spectone finishes
- No protruding legs or hardware
- Standard without glides
- Ships 1/carton 6 cu ft
- Removable threaded cap is fastened with tamperproof fasteners. Sand (not included) can be added on site for additional weight and ballast utilizing the plastic bag from packaging. Contact Customer Service for more information

Options

- Nickel-plated non-removable nylon glides secured with LOCTITE®, add \$20 List
- Floor mounting is available. Please specify a set of nickel-plated non-removable nylon glides secured with LOCTITE for each chair that you want to mount to the floor (\$20 List per chair), and add the same amount of floor mounting kits (\$36 List). In other words, to floor mount 9 chairs, please order 9 sets of glides and 9 floor mounting kits.



Children's Dining

| | |
|-------------|------------|
| MODEL | Price |
| 8702 | 550 |

Dimensions (inches)

| | | | | | |
|--------|------|-------------------|------|---------|------|
| seat H | 15.0 | seat W | 18.0 | total H | 27.0 |
| depth | 20.5 | total W (no arms) | 18.0 | | |

Exceeds BIFMA Seating Durability Test to 500 lbs



8702
Without arms
15.5 lbs



BEHAVIORAL HEALTH & HEAVY DUTY Specialty Seating



PRODUCT CODE

4201M HD

Product Code

Specification

HD: Heavy Duty*

*The code for our heavy duty seating options featured in the pages below is the same as a regular model of the chair you are specifying. By adding the letters "HD" at the end of the product code, it lets us know the product is intended for a behavioral health environment and the features below will automatically be specified.

FEATURES

Tamper-Proof



Weighted



LOCTITE®-secured Glides



Secured Zippers



Springless Seat Cushion



FINISHES

FRAME



Select from one of our 76 standard Spectone colors

FABRIC

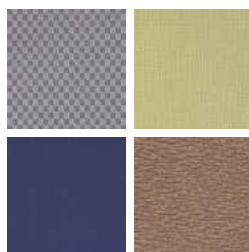

Select fabrics from one of our textile partners

ARMS

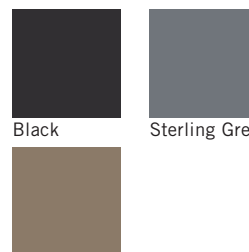

Black

Sterling Grey

Taupe



BEHAVIORAL HEALTH & HEAVY DUTY Specialty Seating

CALVIN HD

Standard Features

- Separate seat and back
- Polyurethane arms
- Fully welded
- Added weight, Sled base
- Frame in any Spectone color
- Injection molded plastic glides secured with LOCTITE®
- Tamperproof hardware
- Ships assembled
- Ships 1/carton 15 cu ft, bariatric ships 1/carton 20 cu ft

Options

- Polyurethane arms are available in Black, Sterling Grey and Taupe (RAL 7006)
- CAL 133

Contact Spec Customer Service to railroad fabrics (specify repeat info and yardage requirement will be provided) and for repeats greater than 5" x 5"



Calvin HD Single Seater with arms

COM 1.75 yds
 0.75 yd COM per single seat
 1.0 yd COM per single back

| MODEL | COM | GR 1 | GR 2 | GR 3 | GR 4 | GR 5 | GR 6 |
|----------------|-------------|-------------|-------------|-------------|-------------|-------------|-------------|
| 8101MHD | 1433 | 1537 | 1569 | 1641 | 1746 | 1826 | 1933 |

Dimensions (inches)

| | | | | | |
|---------|-------|---------|------|-------|------|
| seat H | 18.0 | seat W | 21.0 | arm H | 25.0 |
| total H | 33.75 | total W | 25.0 | depth | 26.0 |

Exceeds BIFMA Seating Durability Test to 500 lbs per chair
 CAL 133, add \$120 List per chair



8101MHD
64 lbs

Calvin HD Bariatric with arms

COM 3.0 yds
 1.5 yd COM per single seat
 1.5 yd COM per single back

| MODEL | COM | GR 1 | GR 2 | GR 3 | GR 4 | GR 5 | GR 6 |
|----------------|-------------|-------------|-------------|-------------|-------------|-------------|-------------|
| 8101GHD | 1757 | 1934 | 1991 | 2112 | 2293 | 2430 | 2615 |

Dimensions (inches)

| | | | | | |
|---------|-------|---------|------|-------|------|
| seat H | 18.0 | seat W | 30.0 | arm H | 25.0 |
| total H | 33.75 | total W | 34.0 | depth | 26.0 |

Exceeds BIFMA Seating Durability Test to 750 lbs per seat
 CAL 133, add \$150 List per chair



8101GHD
74 lbs

BEHAVIORAL HEALTH & HEAVY DUTY Specialty Seating

COMPANION HD

Standard Features

- Separate seat and back
- Polyurethane arms
- Fully welded 1.75" frame
- Added weight, Sled base
- Frame in any Spectone color
- Steel glides secured with LOCTITE®
- Tamperproof hardware
- Zippered covers glued shut, pulls removed
- Ships assembled
- Medium Back ships 1/carton 15 cu ft
- Highback ships 1/carton 19 cu ft

Options

- Polyurethane arms are available in Black, Sterling Grey and Taupe (RAL 7006)
- Floor mounting glides, add \$48 List/chair
- CAL 133

Contact Spec™ Customer Service to railroad fabrics (specify repeat info and yardage requirement will be provided) and for repeats greater than 5" x 5"

Companion HD Medium Back armless – Sled Base

COM 2.0 yds
 1.0 yd COM per single seat
 1.0 yd COM per single back

| MODEL | COM | GR 1 | GR 2 | GR 3 | GR 4 | GR 5 | GR 6 |
|----------------|-------------|-------------|-------------|-------------|-------------|-------------|-------------|
| 4101MHD | 1284 | 1399 | 1435 | 1514 | 1627 | 1714 | 1830 |

Dimensions (inches)

| | | | | | | | |
|---------|------|---------|------|-------|------|--|--|
| seat H | 18.0 | seat W | 21.0 | | | | |
| total H | 32.5 | total W | 25.0 | depth | 27.0 | | |

Exceeds BIFMA Seating Durability Test to 500 lbs per chair
 CAL 133, add \$108 List per chair



4101MHD
65 lbs

Companion HD Medium Back with arms – Sled Base

COM 2.0 yds
 1.0 yd COM per single seat
 1.0 yd COM per single back

| MODEL | COM | GR 1 | GR 2 | GR 3 | GR 4 | GR 5 | GR 6 |
|----------------|-------------|-------------|-------------|-------------|-------------|-------------|-------------|
| 4201MHD | 1507 | 1621 | 1658 | 1737 | 1849 | 1935 | 2052 |

For steel arms add suffix S and \$70

Dimensions (inches)

| | | | | | | | |
|---------|------|---------|------|-------|------|--|--|
| seat H | 18.0 | seat W | 21.0 | arm H | 27.0 | | |
| total H | 32.5 | total W | 26.0 | depth | 27.0 | | |

Exceeds BIFMA Seating Durability Test to 500 lbs per seat
 CAL 133, add \$108 List per chair



4201MHD
65 lbs

BEHAVIORAL HEALTH & HEAVY DUTY Specialty Seating

COMPANION HD

Standard Features

- Separate seat and back
- Polyurethane arms
- Fully welded 1.75" frame
- Added weight, Sled base
- Frame in any Spectone color
- Steel glides secured with LOCTITE®
- Tamperproof hardware
- Zippered covers glued shut, pulls removed
- Ships assembled
- Medium Back ships 1/carton 15 cu ft
- Highback ships 1/carton 19 cu ft

Options

- Polyurethane arms are available in Black, Sterling Grey and Taupe (RAL 7006)
- Floor mounting glides, add \$48 List/chair
- CAL 133

Contact Spec Customer Service to railroad fabrics (specify repeat info and yardage requirement will be provided) and for repeats greater than 5" x 5"



Companion HD Highback with arms – Sled Base

COM 2.25 yds
 1.0 yd COM per single seat
 1.25 yd COM per single back

| MODEL | COM | GR 1 | GR 2 | GR 3 | GR 4 | GR 5 | GR 6 |
|----------------|-------------|-------------|-------------|-------------|-------------|-------------|-------------|
| 4201HHD | 1567 | 1692 | 1737 | 1820 | 1948 | 2043 | 2169 |

For steel arms add suffix S and \$70

Dimensions (inches)

| | | | | | |
|---------|------|---------|------|-------|------|
| seat H | 18.0 | seat W | 21.0 | arm H | 27.0 |
| total H | 45.0 | total W | 26.0 | depth | 27.0 |

Exceeds BIFMA Seating Durability Test to 500 lbs per seat
 CAL 133, add \$134 List per chair



4201HHD
71 lbs

Companion HD Bariatric with arms – Sled Base

COM 3.25 yds
 1.5 yd COM per single seat
 1.75 yd COM per single back

| MODEL | COM | GR 1 | GR 2 | GR 3 | GR 4 | GR 5 | GR 6 |
|----------------|-------------|-------------|-------------|-------------|-------------|-------------|-------------|
| 4201GHD | 1842 | 2013 | 2069 | 2187 | 2355 | 2488 | 2661 |

For steel arms add suffix S and \$70

Dimensions (inches)

| | | | | | |
|---------|------|---------|------|-------|------|
| seat H | 18.0 | seat W | 30.0 | arm H | 27.0 |
| total H | 32.5 | total W | 35.0 | depth | 27.0 |

Exceeds BIFMA Seating Durability Test to 750 lbs per seat
 CAL 133, add \$163 List per chair



4201GHD
78 lbs



BEHAVIORAL HEALTH & HEAVY DUTY Specialty Seating

COOPER DWIGHT HD

Standard Features

- Separate seat and back
- Laminate or upholstered side panels on inside and outside of arm in various combinations
- Upholstered side panels can match or contrast seat/back
- Select from 15 standard laminates or choose any standard Wilsonart, Nevamar, Formica, Arborite and Pionite matte finish laminates at no upcharge.
- Fully welded frame with 1.625" steel legs and 1.25" steel tubular sleds
- Frame in any Spectone color
- Steel glides secured with LOCTITE®
- Replaceable seats
- No protruding legs or hardware
- Tamper proof fastenings
- Ships assembled, 1/carton 15 cu ft

Options

- Wood or polyurethane arm caps, in flat (WF or PF) or rounded (WR or PR) profile
- Wood arm caps in Beech, in any of 9 standard stains or stain-to-match at no upcharge
- Round polyurethane arm caps available in Black, Sterling Grey and Taupe (RAL 7006)
- Flat polyurethane arm caps available in Black only
- KYDEX® flat arms available in Black (B) or Taupe RAL 7006 (T) or Sterling Grey (G)
- Floor mounting straps available, call Customer Service
- Additional weight may be available, call Customer Service
- Antibacterial and antimicrobial fabrics available
- Different fabric on seat and back at no upcharge
- CAL 133

Contact Spec™ Customer Service to railroad fabrics (specify repeat info and yardage requirement will be provided) and for repeats greater than 5" x 5"



Cooper Dwight HD Single Seater with arms

COM 1.75 yds

0.75 yd COM per single seat / 1.0 yd COM per single back

| MODEL | COM | GR 1 | GR 2 | GR 3 | GR 4 | GR 5 | GR 6 |
|-------------------|-------------|-------------|-------------|-------------|-------------|-------------|-------------|
| 6101MHD-LL | 1376 | 1478 | 1512 | 1583 | 1688 | 1770 | 1876 |

Side panel – laminated, outside and inside

CAL 133, add \$120 List per chair



6101MHD-LL
75 lbs

COM 2.5 yds

0.75 yd COM per single seat / 1.0 yd COM per single back / 0.375 yd COM per panel

| MODEL | COM | GR 1 | GR 2 | GR 3 | GR 4 | GR 5 | GR 6 |
|-------------------|-------------|-------------|-------------|-------------|-------------|-------------|-------------|
| 6101MHD-LU | 1448 | 1592 | 1639 | 1739 | 1886 | 1999 | 2148 |

Side panel – laminated, outside, upholstered inside

CAL 133, add \$204 List per chair

COM 2.5 yds

0.75 yd COM per single seat / 1.0 yd COM per single back / 0.375 yd COM per panel

| MODEL | COM | GR 1 | GR 2 | GR 3 | GR 4 | GR 5 | GR 6 |
|-------------------|-------------|-------------|-------------|-------------|-------------|-------------|-------------|
| 6101MHD-UL | 1448 | 1592 | 1639 | 1739 | 1886 | 1999 | 2148 |

Side panel – upholstered outside, laminated inside

CAL 133, add \$204 List per chair

COM 3.25 yds

0.75 yd COM per single seat / 1.0 yd COM per single back / 0.75 yd COM per panel

| MODEL | COM | GR 1 | GR 2 | GR 3 | GR 4 | GR 5 | GR 6 |
|-------------------|-------------|-------------|-------------|-------------|-------------|-------------|-------------|
| 6101MHD-UU | 1486 | 1671 | 1733 | 1861 | 2049 | 2194 | 2387 |

Side panel – upholstered, outside and inside

CAL 133, add \$284 List per chair

Dimensions (inches)

| | | | | | |
|---------|-------|---------|-------|-------|------|
| seat H | 18.0 | seat W | 21.0 | arm H | 25.0 |
| total H | 33.75 | total W | 25.25 | depth | 25.0 |

For KYDEX® flat arms add suffix K and \$274

Dynamic load tested to 500 lbs per chair



BEHAVIORAL HEALTH & HEAVY DUTY Specialty Seating

COOPER DWIGHT HD

Standard Features

- Separate seat and back
- Laminate or upholstered side panels on inside and outside of arm in various combinations
- Upholstered side panels can match or contrast seat/back
- Select from 15 standard laminates or choose any standard Wilsonart, Nevamar, Formica, Arborite and Pionite matte finish laminates at no upcharge.
- Fully welded frame with 1.625" steel legs and 1.25" steel tubular sleds
- Frame in any Spectone color
- Steel glides secured with LOCTITE®
- Replaceable seats
- No protruding legs or hardware
- Tamper proof fastenings
- Ships assembled, 1/carton 15 cu ft

Options

- Wood or polyurethane arm caps, in flat (WF or PF) or rounded (WR or PR) profile
- Wood arm caps in Beech, in any of 9 standard stains or stain-to-match at no upcharge
- Round polyurethane arm caps available in Black, Sterling Grey and Taupe (RAL 7006)
- Flat polyurethane arm caps available in Black only
- KYDEX® flat arms available in Black (B) or Taupe RAL 7006 (T) or Sterling Grey (G)
- Floor mounting straps available, call Customer Service
- Additional weight may be available, call Customer Service
- Antibacterial and antimicrobial fabrics available
- Different fabric on seat and back at no upcharge
- CAL 133

Contact Spec Customer Service to railroad fabrics (specify repeat info and yardage requirement will be provided) and for repeats greater than 5" x 5"



Cooper Dwight HD Single Seater with no arms

COM 1.75 yds

0.75 yd COM per single seat / 1.0 yd COM per single back

| MODEL | COM | GR 1 | GR 2 | GR 3 | GR 4 | GR 5 | GR 6 |
|---------------------|-------------|-------------|-------------|-------------|-------------|-------------|-------------|
| 6101MHD-LL-N | 1332 | 1435 | 1470 | 1540 | 1645 | 1726 | 1832 |

Side panel – laminated, outside and inside

CAL 133, add \$120 List per chair

COM 2.5 yds

0.75 yd COM per single seat / 1.0 yd COM per single back / 0.375 yd COM per panel

| MODEL | COM | GR 1 | GR 2 | GR 3 | GR 4 | GR 5 | GR 6 |
|---------------------|-------------|-------------|-------------|-------------|-------------|-------------|-------------|
| 6101MHD-LU-N | 1394 | 1527 | 1569 | 1662 | 1796 | 1900 | 2037 |

Side panel – laminated, outside, upholstered inside

CAL 133, add \$204 List per chair

COM 2.5 yds

0.75 yd COM per single seat / 1.0 yd COM per single back / 0.375 yd COM per panel

| MODEL | COM | GR 1 | GR 2 | GR 3 | GR 4 | GR 5 | GR 6 |
|---------------------|-------------|-------------|-------------|-------------|-------------|-------------|-------------|
| 6101MHD-UL-N | 1394 | 1527 | 1569 | 1662 | 1796 | 1900 | 2037 |

Side panel – upholstered outside, laminated inside

CAL 133, add \$204 List per chair

COM 3.25 yds

0.75 yd COM per single seat / 1.0 yd COM per single back / 0.75 yd COM per panel

| MODEL | COM | GR 1 | GR 2 | GR 3 | GR 4 | GR 5 | GR 6 |
|---------------------|-------------|-------------|-------------|-------------|-------------|-------------|-------------|
| 6101MHD-UU-N | 1432 | 1594 | 1647 | 1759 | 1924 | 2051 | 2218 |

Side panel – upholstered, outside and inside

CAL 133, add \$284 List per chair

Dimensions (inches)

| | | | | | |
|---------|-------|---------|-------|-------|------|
| seat H | 18.0 | seat W | 21.0 | arm H | 20.0 |
| total H | 33.75 | total W | 25.25 | depth | 25.0 |

For KYDEX® flat arms add suffix K and \$274

Dynamic load tested to 500 lbs per chair



6101MHD-LL-N
70 lbs



BEHAVIORAL HEALTH & HEAVY DUTY Specialty Seating

DIGNITY

Standard Features

- Separate seat and back
- Self-skinned polyurethane perimeter arms
- Upholstered side panels can match or contrast seat/back
- Laminate or upholstered side panels on inside and outside of arm
- Select from 15 standard laminates or choose any standard Wilsonart, Nevamar, Formica, Arborite and Pionite matte finish laminates at no upcharge.
- No protruding legs or hardware
- Tamper proof fastenings
- Non-removable steel levelling glides
- Ships assembled
- Ships 1/carton 15 cu ft

Contact Spec Customer Service to railroad fabrics (specify repeat info and yardage requirement will be provided) and for repeats greater than 5" x 5"

Options

- Specify frame finish, Black (B), Sterling Grey (G) or Taupe RAL 7006 (T)
- Add up to 20 lbs of additional weight per seat, add \$162 List per seat
- Non-standard laminates, contact Spec for pricing
- Antibacterial and antimicrobial fabrics available
- Floor mounting straps available, call Customer Service
- Connecting and freestanding tables
- CAL 133
- Elimination of separated seat and back available with either solid or perforated seat pan, call Customer Service

Single Seater with arms

COM 1.75 yds

0.75 yd COM per single seat / 1.0 yd COM per single back

| MODEL | COM | GR 1 | GR 2 | GR 3 | GR 4 | GR 5 | GR 6 |
|-----------------|-------------|-------------|-------------|-------------|-------------|-------------|-------------|
| 4501M-LL | 1474 | 1567 | 1597 | 1658 | 1749 | 1819 | 1909 |

Arm panel – laminated, outside and inside
CAL 133, add \$120 List per chair



4501M
107 lbs

COM 2.75 yds

0.75 yd COM per single seat / 1.0 yd COM per single back / .5 yd COM per panel

| MODEL | COM | GR 1 | GR 2 | GR 3 | GR 4 | GR 5 | GR 6 |
|-----------------|-------------|-------------|-------------|-------------|-------------|-------------|-------------|
| 4501M-LU | 1591 | 1736 | 1783 | 1879 | 2023 | 2129 | 2274 |

Arm panel – laminated, outside, upholstered inside
CAL 133, add \$204 List per chair

COM 2.75 yds

0.75 yd COM per single seat / 1.0 yd COM per single back / .5 yd COM per panel

| MODEL | COM | GR 1 | GR 2 | GR 3 | GR 4 | GR 5 | GR 6 |
|-----------------|-------------|-------------|-------------|-------------|-------------|-------------|-------------|
| 4501M-UL | 1591 | 1736 | 1783 | 1879 | 2023 | 2129 | 2274 |

Arm panel – upholstered outside, laminated inside
CAL 133, add \$204 List per chair

COM 3.75 yds

0.75 yd COM per single seat / 1.0 yd COM per single back / 1.0 yd COM per panel

| MODEL | COM | GR 1 | GR 2 | GR 3 | GR 4 | GR 5 | GR 6 |
|-----------------|-------------|-------------|-------------|-------------|-------------|-------------|-------------|
| 4501M-UU | 1707 | 1904 | 1968 | 2100 | 2293 | 2442 | 2637 |

Arm panel – upholstered, outside and inside
CAL 133, add \$284 List per chair

Dimensions (inches)

| | | | | | |
|---------|-------|---------|------|-------|-------|
| seat H | 18.0 | seat W | 23.0 | arm H | 25.25 |
| total H | 32.75 | total W | 29.0 | depth | 29.75 |

Exceeds BIFMA Seating Durability Test to 500 lbs per chair



BEHAVIORAL HEALTH & HEAVY DUTY Specialty Seating

DIGNITY

Standard Features

- Separate seat and back
- Self-skinned polyurethane perimeter arms
- Upholstered side panels can match or contrast seat/back
- Laminate or upholstered side panels on inside and outside of arm
- Select from 15 standard laminates or choose any standard Wilsonart, Nevamar, Formica, Arborite and Pionite matte finish laminates at no upcharge.
- No protruding legs or hardware
- Tamper proof fastenings
- Non-removable steel levelling glides
- Ships assembled
- Ships 1/carton 26 cu ft

Contact Spec Customer Service to railroad fabrics (specify repeat info and yardage requirement will be provided) and for repeats greater than 5" x 5"

Options

- Specify frame finish, Black (B), Sterling Grey (G) or Taupe RAL 7006 (T)
- Add up to 20 lbs of additional weight per seat, add \$162 List per seat
- Non-standard laminates, contact Spec for pricing
- Antibacterial and antimicrobial fabrics available
- Floor mounting straps available, call Customer Service
- Connecting and freestanding tables
- CAL 133
- Elimination of separated seat and back available with either solid or perforated seat pan, call Customer Service

Two Seater with outside arms

COM 3.5 yds

0.75 yd COM per single seat / 1.0 yd COM per single back

| MODEL | COM | GR 1 | GR 2 | GR 3 | GR 4 | GR 5 | GR 6 |
|-----------------|-------------|-------------|-------------|-------------|-------------|-------------|-------------|
| 4502M-LL | 2166 | 2349 | 2409 | 2531 | 2714 | 2851 | 3035 |

Arm panel – laminated, outside and inside

CAL 133, add \$240 List per two seater

COM 4.5 yds

0.75 yd COM per single seat / 1.0 yd COM per single back / .5 yd COM per panel

| MODEL | COM | GR 1 | GR 2 | GR 3 | GR 4 | GR 5 | GR 6 |
|-----------------|-------------|-------------|-------------|-------------|-------------|-------------|-------------|
| 4502M-LU | 2282 | 2518 | 2597 | 2751 | 2988 | 3165 | 3399 |

Arm panel – laminated, outside, upholstered inside

CAL 133, add \$324 List per two seater

COM 4.5 yds

0.75 yd COM per single seat / 1.0 yd COM per single back / .5 yd COM per panel

| MODEL | COM | GR 1 | GR 2 | GR 3 | GR 4 | GR 5 | GR 6 |
|-----------------|-------------|-------------|-------------|-------------|-------------|-------------|-------------|
| 4502M-UL | 2282 | 2518 | 2597 | 2751 | 2988 | 3165 | 3399 |

Arm panel – upholstered outside, laminated inside

CAL 133, add \$324 List per two seater

COM 5.5 yds

0.75 yd COM per single seat / 1.0 yd COM per single back / 1.0 yd COM per panel

| MODEL | COM | GR 1 | GR 2 | GR 3 | GR 4 | GR 5 | GR 6 |
|-----------------|-------------|-------------|-------------|-------------|-------------|-------------|-------------|
| 4502M-UU | 2397 | 2686 | 2781 | 2972 | 3258 | 3475 | 3766 |

Arm panel – upholstered, outside and inside

CAL 133, add \$408 List per two seater



4502M
152 lbs

Dimensions (inches)

| | | | | | |
|---------|-------|---------|------|-------|-------|
| seat H | 18.0 | seat W | 46.0 | arm H | 25.25 |
| total H | 32.75 | total W | 52.0 | depth | 29.75 |

Exceeds BIFMA Seating Durability Test to 750 lbs per two seater



BEHAVIORAL HEALTH & HEAVY DUTY Specialty Seating

DIGNITY

Standard Features

- Separate seat and back
- Self-skinned polyurethane perimeter arms
- Upholstered side panels can match or contrast seat/back
- Laminate or upholstered side panels on inside and outside of arm
- Select from 15 standard laminates or choose any standard Wilsonart, Nevamar, Formica, Arborite and Pionite matte finish laminates at no upcharge.
- No protruding legs or hardware
- Tamper proof fastenings
- Non-removable steel levelling glides
- Ships assembled
- Ships 1/carton 39 cu ft

Contact Spec Customer Service to railroad fabrics (specify repeat info and yardage requirement will be provided) and for repeats greater than 5" x 5"

Options

- Specify frame finish, Black (B), Sterling Grey (G) or Taupe RAL 7006 (T)
- Add up to 20 lbs of additional weight per seat, add \$162 List per seat
- Non-standard laminates, contact Spec for pricing
- Antibacterial and antimicrobial fabrics available
- Floor mounting straps available, call Customer Service
- Connecting and freestanding tables
- CAL 133
- Elimination of separated seat and back available with either solid or perforated seat pan, call Customer Service



Three Seater with outside arms

COM 5.25 yds

0.75 yd COM per single seat / 1.0 yd COM per single back

| MODEL | COM | GR 1 | GR 2 | GR 3 | GR 4 | GR 5 | GR 6 |
|-----------------|-------------|-------------|-------------|-------------|-------------|-------------|-------------|
| 4503M-LL | 2856 | 3132 | 3224 | 3406 | 3680 | 3886 | 4162 |

Arm panel – laminated, outside and inside

CAL 133, add \$360 List per three seater



4503M
197 lbs

COM 6.25 yds

0.75 yd COM per single seat / 1.0 yd COM per single back / .5 yd COM per panel

| MODEL | COM | GR 1 | GR 2 | GR 3 | GR 4 | GR 5 | GR 6 |
|-----------------|-------------|-------------|-------------|-------------|-------------|-------------|-------------|
| 4503M-LU | 2971 | 3300 | 3408 | 3628 | 3953 | 4197 | 4526 |

Arm panel – laminated, outside, upholstered inside

CAL 133, add \$444 List per three seater

COM 6.25 yds

0.75 yd COM per single seat / 1.0 yd COM per single back / .5 yd COM per panel

| MODEL | COM | GR 1 | GR 2 | GR 3 | GR 4 | GR 5 | GR 6 |
|-----------------|-------------|-------------|-------------|-------------|-------------|-------------|-------------|
| 4503M-UL | 2971 | 3300 | 3408 | 3628 | 3953 | 4197 | 4526 |

Arm panel – upholstered outside, laminated inside

CAL 133, add \$444 List per three seater

COM 7.25 yds

0.75 yd COM per single seat / 1.0 yd COM per single back / 1.0 yd COM per panel

| MODEL | COM | GR 1 | GR 2 | GR 3 | GR 4 | GR 5 | GR 6 |
|-----------------|-------------|-------------|-------------|-------------|-------------|-------------|-------------|
| 4503M-UU | 3088 | 3470 | 3595 | 3848 | 4223 | 4509 | 4892 |

Arm panel – upholstered, outside and inside

CAL 133, add \$528 List per three seater

Dimensions (inches)

| | | | | | |
|---------|-------|---------|------|-------|-------|
| seat H | 18.0 | seat W | 69.0 | arm H | 25.25 |
| total H | 32.75 | total W | 75.0 | depth | 29.75 |

Exceeds BIFMA Seating Durability Test to 1000 lbs per three seater



BEHAVIORAL HEALTH & HEAVY DUTY Specialty Seating

DIGNITY

Standard Features

- Separate seat and back
- Self-skinned polyurethane perimeter arms
- Upholstered side panels can match or contrast seat/back
- Laminate or upholstered side panels on inside and outside of arm
- Select from 15 standard laminates or choose any standard Wilsonart, Nevamar, Formica, Arborite and Pionite matte finish laminates at no upcharge.
- No protruding legs or hardware
- Tamper proof fastenings
- Non-removable steel levelling glides
- Ships assembled
- Ships 1/carton 20 cu ft

Contact Spec Customer Service to railroad fabrics (specify repeat info and yardage requirement will be provided) and for repeats greater than 5" x 5"

Options

- Specify frame finish, Black (B), Sterling Grey (G) or Taupe RAL 7006 (T)
- Add up to 20 lbs of additional weight per seat, add \$162 List per seat
- Non-standard laminates, contact Spec for pricing
- Antibacterial and antimicrobial fabrics available
- Floor mounting straps available, call Customer Service
- Connecting and freestanding tables
- CAL 133
- Elimination of separated seat and back available with either solid or perforated seat pan, call Customer Service



Bariatric Single Seater with arms

COM 3.25 yds

1.5 yd COM per single seat / 1.75 yd COM per single back

| MODEL | COM | GR 1 | GR 2 | GR 3 | GR 4 | GR 5 | GR 6 |
|-----------------|-------------|-------------|-------------|-------------|-------------|-------------|-------------|
| 4501G-LL | 1907 | 2079 | 2134 | 2247 | 2417 | 2546 | 2716 |

Arm panel – laminated, outside and inside

CAL 133, add \$154 List per chair



4501G
116 lbs

COM 4.25 yds

1.5 yd COM per single seat / 1.75 yd COM per single back / .5 yd COM per panel

| MODEL | COM | GR 1 | GR 2 | GR 3 | GR 4 | GR 5 | GR 6 |
|-----------------|-------------|-------------|-------------|-------------|-------------|-------------|-------------|
| 4501G-LU | 2024 | 2247 | 2320 | 2467 | 2688 | 2855 | 3078 |

Arm panel – laminated, outside, upholstered inside

CAL 133, add \$233 List per chair

COM 4.25 yds

1.5 yd COM per single seat / 1.75 yd COM per single back / .5 yd COM per panel

| MODEL | COM | GR 1 | GR 2 | GR 3 | GR 4 | GR 5 | GR 6 |
|-----------------|-------------|-------------|-------------|-------------|-------------|-------------|-------------|
| 4501G-UL | 2024 | 2247 | 2320 | 2467 | 2688 | 2855 | 3078 |

Arm panel – upholstered outside, laminated inside

CAL 133, add \$233 List per chair

COM 5.25 yds

1.5 yd COM per single seat / 1.75 yd COM per single back / 1.0 yd COM per panel

| MODEL | COM | GR 1 | GR 2 | GR 3 | GR 4 | GR 5 | GR 6 |
|-----------------|-------------|-------------|-------------|-------------|-------------|-------------|-------------|
| 4501G-UU | 2140 | 2416 | 2506 | 2688 | 2963 | 3170 | 3447 |

Arm panel – upholstered, outside and inside

CAL 133, add \$312 List per chair

Dimensions (inches)

| | | | | | |
|---------|-------|---------|-------|-------|-------|
| seat H | 18.0 | seat W | 30.25 | arm H | 25.25 |
| total H | 32.75 | total W | 36.25 | depth | 29.75 |

Exceeds BIFMA Seating Durability Test to 750 lbs per chair

BEHAVIORAL HEALTH & HEAVY DUTY Specialty Seating DIGNITY

Standard Features

- Black finish only
- 6" soft wheel casters
- Standard Dolly holds 1 single seat chair
- Ships 1/carton, 17 cu. ft.
- Ships assembled



Dignity - Dolly

| Description | Model | Price | Weight |
|-------------------|----------------|------------|-------------|
| Single Seat Dolly | DIGN-99 | 557 | 12lb |

Dimensions (inches)

| | |
|--------|------|
| height | 39.0 |
| width | 23.0 |
| depth | 30.0 |





BEHAVIORAL HEALTH & HEAVY DUTY Specialty Seating

DIGNITY2

Standard Features

- Separate seat and back
- Arm caps available in wood, or polyurethane
- Laminate or upholstered side panels on inside and outside of arm in various combinations
- Upholstered side panels can match or contrast seat/back
- Select from 15 standard laminates or choose any standard Wilsonart, Nevamar, Formica, Arborite and Pionite matte finish laminates at no upcharge.
- Sculpted steel leg in any Spectone finish
- No protruding legs or hardware
- Tamper proof fastenings
- Non-removable steel levelling glides
- Ships assembled
- Ships 1/carton 15 cu ft

Options

- Polyurethane arm caps available in Black (B) or Taupe RAL 7006 (T) or Sterling Grey (G)
- For wood arm caps, select from 9 standard stains, or stain-to-match at no upcharge
- KYDEX® arm caps available in Black (B) or Taupe RAL 7006 (T) or Sterling Grey (G)
- Thermofoil side panels on inside and outside of arm, call Customer Service for pricing and finishes
- Add up to 20 lbs of additional weight per seat, add \$162 List per seat
- Non-standard laminates, contact Spec for pricing
- Antibacterial and antimicrobial fabrics available
- Floor mounting straps available, call Customer Service
- Connecting and freestanding tables
- CAL 133
- Elimination of separated seat and back available with either solid or perforated seat pan, call Customer Service

Contact Spec Customer Service to railroad fabrics (specify repeat info and yardage requirement will be provided) and for repeats greater than 5" x 5"

Single Seater with arms

COM 1.75 yds

0.75 yd COM per single seat / 1.0 yd COM per single back

| MODEL | COM | GR 1 | GR 2 | GR 3 | GR 4 | GR 5 | GR 6 |
|-----------------|-------------|-------------|-------------|-------------|-------------|-------------|-------------|
| 4601M-LL | 1474 | 1567 | 1597 | 1658 | 1749 | 1819 | 1909 |

Side panel – laminated, outside and inside

CAL 133, add \$120 List per chair

COM 2.75 yds

0.75 yd COM per single seat / 1.0 yd COM per single back / .5 yd COM per panel

| MODEL | COM | GR 1 | GR 2 | GR 3 | GR 4 | GR 5 | GR 6 |
|-----------------|-------------|-------------|-------------|-------------|-------------|-------------|-------------|
| 4601M-LU | 1591 | 1736 | 1783 | 1879 | 2023 | 2129 | 2274 |

Side panel – laminated, outside, upholstered inside

CAL 133, add \$204 List per chair

COM 2.75 yds

0.75 yd COM per single seat / 1.0 yd COM per single back / .5 yd COM per panel

| MODEL | COM | GR 1 | GR 2 | GR 3 | GR 4 | GR 5 | GR 6 |
|-----------------|-------------|-------------|-------------|-------------|-------------|-------------|-------------|
| 4601M-UL | 1591 | 1736 | 1783 | 1879 | 2023 | 2129 | 2274 |

Side panel – upholstered outside, laminated inside

CAL 133, add \$204 List per chair

COM 3.75 yds

0.75 yd COM per single seat / 1.0 yd COM per single back / 1.0 yd COM per panel

| MODEL | COM | GR 1 | GR 2 | GR 3 | GR 4 | GR 5 | GR 6 |
|-----------------|-------------|-------------|-------------|-------------|-------------|-------------|-------------|
| 4601M-UU | 1707 | 1904 | 1968 | 2100 | 2293 | 2442 | 2637 |

Side panel – upholstered, outside and inside

CAL 133, add \$284 List per chair

Dimensions (inches)

| | | | | | |
|---------|-------|---------|------|-------|------|
| seat H | 18.0 | seat W | 23.0 | arm H | 26.0 |
| total H | 31.75 | total W | 28.5 | depth | 30.0 |

For KYDEX® arms add suffix K and \$262
Dynamic load tested to 500 lbs per chair



4601M
94 lbs



BEHAVIORAL HEALTH & HEAVY DUTY Specialty Seating

DIGNITY2

Standard Features

- Separate seat and back
- Arm caps available in wood, or polyurethane
- Laminate or upholstered side panels on inside and outside of arm in various combinations
- Upholstered side panels can match or contrast seat/back
- Select from 15 standard laminates or choose any standard Wilsonart, Nevamar, Formica, Arborite and Pionite matte finish laminates at no upcharge.
- Sculpted steel leg in any Spectone finish
- No protruding legs or hardware
- Tamper proof fastenings
- Non-removable steel levelling glides
- Ships assembled
- Ships 1/carton 15 cu ft

Options

- Polyurethane arm caps available in Black (B) or Taupe RAL 7006 (T) or Sterling Grey (G)
- For wood arm caps, select from 9 standard stains, or stain-to-match at no upcharge
- KYDEX® arm caps available in Black (B) or Taupe RAL 7006 (T) or Sterling Grey (G)
- Thermofoil side panels on inside and outside of arm, call Customer Service for pricing and finishes
- Add up to 20 lbs of additional weight per seat, add \$162 List per seat
- Non-standard laminates, contact Spec for pricing
- Antibacterial and antimicrobial fabrics available
- Floor mounting straps available, call Customer Service
- Connecting and freestanding tables
- CAL 133
- Elimination of separated seat and back available with either solid or perforated seat pan, call Customer Service

Contact Spec Customer Service to railroad fabrics (specify repeat info and yardage requirement will be provided) and for repeats greater than 5" x 5"

Two Seater with outside arms

COM 3.5 yds
0.75 yd COM per single seat / 1.0 yd COM per single back

| MODEL | COM | GR 1 | GR 2 | GR 3 | GR 4 | GR 5 | GR 6 |
|-----------------|-------------|-------------|-------------|-------------|-------------|-------------|-------------|
| 4602M-LL | 2166 | 2349 | 2409 | 2531 | 2714 | 2851 | 3035 |

Side panel – laminated, outside and inside
CAL 133, add \$240 List per two seater



4602M
148 lbs

COM 4.5 yds
0.75 yd COM per single seat / 1.0 yd COM per single back / .5 yd COM per panel

| MODEL | COM | GR 1 | GR 2 | GR 3 | GR 4 | GR 5 | GR 6 |
|-----------------|-------------|-------------|-------------|-------------|-------------|-------------|-------------|
| 4602M-UL | 2282 | 2518 | 2597 | 2751 | 2988 | 3165 | 3399 |

Side panel – laminated, outside, upholstered inside
CAL 133, add \$324 List per two seater

COM 4.5 yds
0.75 yd COM per single seat / 1.0 yd COM per single back / .5 yd COM per panel

| MODEL | COM | GR 1 | GR 2 | GR 3 | GR 4 | GR 5 | GR 6 |
|-----------------|-------------|-------------|-------------|-------------|-------------|-------------|-------------|
| 4602M-UL | 2282 | 2518 | 2597 | 2751 | 2988 | 3165 | 3399 |

Side panel – upholstered outside, laminated inside
CAL 133, add \$324 List per two seater

COM 5.5 yds
0.75 yd COM per single seat / 1.0 yd COM per single back / 1.0 yd COM per panel

| MODEL | COM | GR 1 | GR 2 | GR 3 | GR 4 | GR 5 | GR 6 |
|-----------------|-------------|-------------|-------------|-------------|-------------|-------------|-------------|
| 4602M-UU | 2397 | 2686 | 2781 | 2972 | 3258 | 3475 | 3766 |

Side panel – upholstered, outside and inside
CAL 133, add \$408 List per two seater

Dimensions (inches)

| | | | | | |
|---------|-------|---------|------|-------|------|
| seat H | 18.0 | seat W | 45.5 | arm H | 26.0 |
| total H | 31.75 | total W | 51.0 | depth | 30.0 |

For KYDEX® arms add suffix K and \$262
Dynamic load tested to 750 lbs per two seater

BEHAVIORAL HEALTH & HEAVY DUTY Specialty Seating

DIGNITY2

Standard Features

- Separate seat and back
- Arm caps available in wood, or polyurethane
- Laminate or upholstered side panels on inside and outside of arm in various combinations
- Upholstered side panels can match or contrast seat/back
- Select from 15 standard laminates or choose any standard Wilsonart, Nevamar, Formica, Arborite and Pionite matte finish laminates at no upcharge.
- Sculpted steel leg in any Spectone finish
- No protruding legs or hardware
- Tamper proof fastenings
- Non-removable steel levelling glides
- Ships assembled
- Ships 1/carton 15 cu ft

Options

- Polyurethane arm caps available in Black (B) or Taupe RAL 7006 (T) or Sterling Grey (G)
- For wood arm caps, select from 9 standard stains, or stain-to-match at no upcharge
- KYDEX® arm caps available in Black (B) or Taupe RAL 7006 (T) or Sterling Grey (G)
- Thermofoil side panels on inside and outside of arm, call Customer Service for pricing and finishes
- Add up to 20 lbs of additional weight per seat, add \$162 List per seat
- Non-standard laminates, contact Spec for pricing
- Antibacterial and antimicrobial fabrics available
- Floor mounting straps available, call Customer Service
- Connecting and freestanding tables
- CAL 133
- Elimination of separated seat and back available with either solid or perforated seat pan, call Customer Service

Contact Spec Customer Service to railroad fabrics (specify repeat info and yardage requirement will be provided) and for repeats greater than 5" x 5"

Three Seater with outside arms

COM 5.25 yds

0.75 yd COM per single seat / 1.0 yd COM per single back

| MODEL | COM | GR 1 | GR 2 | GR 3 | GR 4 | GR 5 | GR 6 |
|-----------------|-------------|-------------|-------------|-------------|-------------|-------------|-------------|
| 4603M-LL | 2856 | 3132 | 3224 | 3406 | 3680 | 3886 | 4162 |

Side panel – laminated, outside and inside

CAL 133, add \$360 List per three seater

COM 6.25 yds

0.75 yd COM per single seat / 1.0 yd COM per single back / .5 yd COM per panel

| MODEL | COM | GR 1 | GR 2 | GR 3 | GR 4 | GR 5 | GR 6 |
|-----------------|-------------|-------------|-------------|-------------|-------------|-------------|-------------|
| 4603M-LU | 2971 | 3300 | 3408 | 3628 | 3953 | 4197 | 4526 |

Side panel – laminated, outside, upholstered inside

CAL 133, add \$444 List per three seater

COM 6.25 yds

0.75 yd COM per single seat / 1.0 yd COM per single back / .5 yd COM per panel

| MODEL | COM | GR 1 | GR 2 | GR 3 | GR 4 | GR 5 | GR 6 |
|-----------------|-------------|-------------|-------------|-------------|-------------|-------------|-------------|
| 4603M-UL | 2971 | 3300 | 3408 | 3628 | 3953 | 4197 | 4526 |

Side panel – upholstered outside, laminated inside

CAL 133, add \$444 List per three seater

COM 7.25 yds

0.75 yd COM per single seat / 1.0 yd COM per single back / 1.0 yd COM per panel

| MODEL | COM | GR 1 | GR 2 | GR 3 | GR 4 | GR 5 | GR 6 |
|-----------------|-------------|-------------|-------------|-------------|-------------|-------------|-------------|
| 4603M-UU | 3088 | 3470 | 3595 | 3848 | 4223 | 4509 | 4892 |

Side panel – upholstered, outside and inside

CAL 133, add \$528 List per three seater

Dimensions (inches)

| | | | | | |
|---------|-------|---------|------|-------|------|
| seat H | 18.0 | seat W | 68.0 | arm H | 26.0 |
| total H | 31.75 | total W | 74.0 | depth | 30.0 |

For KYDEX® arms add suffix K and \$262

Dynamic load tested to 1000 lbs per three seater



4603M
203 lbs



BEHAVIORAL HEALTH & HEAVY DUTY Specialty Seating

DIGNITY2

Standard Features

- Separate seat and back
- Arm caps available in wood, or polyurethane
- Laminate or upholstered side panels on inside and outside of arm in various combinations
- Upholstered side panels can match or contrast seat/back
- Select from 15 standard laminates or choose any standard Wilsonart, Nevamar, Formica, Arborite and Pionite matte finish laminates at no upcharge.
- Sculpted steel leg in any Spectone finish
- No protruding legs or hardware
- Tamper proof fastenings
- Non-removable steel levelling glides
- Ships assembled
- Ships 1/carton 15 cu ft

Options

- Polyurethane arm caps available in Black (B) or Taupe RAL 7006 (T) or Sterling Grey (G)
- For wood arm caps, select from 9 standard stains, or stain-to-match at no upcharge
- KYDEX® arm caps available in Black (B) or Taupe RAL 7006 (T) or Sterling Grey (G)
- Thermofoil side panels on inside and outside of arm, call Customer Service for pricing and finishes
- Add up to 20 lbs of additional weight per seat, add \$162 List per seat
- Non-standard laminates, contact Spec for pricing
- Antibacterial and antimicrobial fabrics available
- Floor mounting straps available, call Customer Service
- Connecting and freestanding tables
- CAL 133
- Elimination of separated seat and back available with either solid or perforated seat pan, call Customer Service

Contact Spec Customer Service to railroad fabrics (specify repeat info and yardage requirement will be provided) and for repeats greater than 5" x 5"

Bariatric Single Seater with arms

COM 3.25 yds

1.5 yd COM per single seat / 1.75 yd COM per single back

| MODEL | COM | GR 1 | GR 2 | GR 3 | GR 4 | GR 5 | GR 6 |
|-----------------|-------------|-------------|-------------|-------------|-------------|-------------|-------------|
| 4601G-LL | 1907 | 2079 | 2134 | 2247 | 2417 | 2546 | 2716 |

Side panel – laminated, outside and inside

CAL 133, add \$154 List per chair

COM 4.25 yds

1.5 yd COM per single seat / 1.75 yd COM per single back / .5 yd COM per panel

| MODEL | COM | GR 1 | GR 2 | GR 3 | GR 4 | GR 5 | GR 6 |
|-----------------|-------------|-------------|-------------|-------------|-------------|-------------|-------------|
| 4601G-LU | 2024 | 2247 | 2320 | 2467 | 2688 | 2855 | 3078 |

Side panel – laminated, outside, upholstered inside

CAL 133, add \$233 List per chair

COM 4.25 yds

1.5 yd COM per single seat / 1.75 yd COM per single back / .5 yd COM per panel

| MODEL | COM | GR 1 | GR 2 | GR 3 | GR 4 | GR 5 | GR 6 |
|-----------------|-------------|-------------|-------------|-------------|-------------|-------------|-------------|
| 4601G-UL | 2024 | 2247 | 2320 | 2467 | 2688 | 2855 | 3078 |

Side panel – upholstered outside, laminated inside

CAL 133, add \$233 List per chair

COM 5.25 yds

1.5 yd COM per single seat / 1.75 yd COM per single back / 1.0 yd COM per panel

| MODEL | COM | GR 1 | GR 2 | GR 3 | GR 4 | GR 5 | GR 6 |
|-----------------|-------------|-------------|-------------|-------------|-------------|-------------|-------------|
| 4601G-UU | 2140 | 2416 | 2506 | 2688 | 2963 | 3170 | 3447 |

Side panel – upholstered, outside and inside

CAL 133, add \$312 List per chair

Dimensions (inches)

| | | | | | |
|---------|-------|---------|------|-------|------|
| seat H | 18.0 | seat W | 31.0 | arm H | 26.0 |
| total H | 31.75 | total W | 36.5 | depth | 30.0 |

For KYDEX® arms add suffix K and \$262
Dynamic load tested to 750 lbs per chair



4601G
112 lbs



BEHAVIORAL HEALTH & HEAVY DUTY Specialty Seating

DIGNITY2

Standard Features

- Separate seat and back
- Arm caps available in wood, or polyurethane
- Laminate or upholstered side panels on inside and outside of arm in various combinations
- Upholstered side panels can match or contrast seat/back
- Select from 15 standard laminates or choose any standard Wilsonart, Nevamar, Formica, Arborite and Pionite matte finish laminates at no upcharge.
- Sculpted steel leg in any Spectone finish
- No protruding legs or hardware
- Tamper proof fastenings
- Non-removable steel levelling glides
- Ships assembled
- Ships 1/carton 15 cu ft

Options

- Polyurethane arm caps available in Black (B) or Taupe RAL 7006 (T) or Sterling Grey (G)
- For wood arm caps, select from 9 standard stains, or stain-to-match at no upcharge
- KYDEX® arm caps available in Black (B) or Taupe RAL 7006 (T) or Sterling Grey (G)
- Thermofoil side panels on inside and outside of arm, call Customer Service for pricing and finishes
- Add up to 20 lbs of additional weight per seat, add \$162 List per seat
- Non-standard laminates, contact Spec for pricing
- Antibacterial and antimicrobial fabrics available
- Floor mounting straps available, call Customer Service
- Connecting and freestanding tables
- CAL 133
- Elimination of separated seat and back available with either solid or perforated seat pan, call Customer Service

Contact Spec Customer Service to railroad fabrics (specify repeat info and yardage requirement will be provided) and for repeats greater than 5" x 5"

Single Seater with no arms

COM 1.75 yds
0.75 yd COM per single seat / 1.0 yd COM per single back

| MODEL | COM | GR 1 | GR 2 | GR 3 | GR 4 | GR 5 | GR 6 |
|-------------------|-------------|-------------|-------------|-------------|-------------|-------------|-------------|
| 4601M-LL-N | 1453 | 1544 | 1575 | 1636 | 1727 | 1796 | 1889 |

Side panel – laminated, outside and inside
CAL 133, add \$120 List per chair

COM 2.75 yds
0.75 yd COM per single seat / 1.0 yd COM per single back / .5 yd COM per panel

| MODEL | COM | GR 1 | GR 2 | GR 3 | GR 4 | GR 5 | GR 6 |
|-------------------|-------------|-------------|-------------|-------------|-------------|-------------|-------------|
| 4601M-LU-N | 1568 | 1713 | 1760 | 1856 | 2001 | 2107 | 2251 |

Side panel – laminated, outside, upholstered inside
CAL 133, add \$204 List per chair

COM 2.75 yds
0.75 yd COM per single seat / 1.0 yd COM per single back / .5 yd COM per panel

| MODEL | COM | GR 1 | GR 2 | GR 3 | GR 4 | GR 5 | GR 6 |
|-------------------|-------------|-------------|-------------|-------------|-------------|-------------|-------------|
| 4601M-UL-N | 1568 | 1713 | 1760 | 1856 | 2001 | 2107 | 2251 |

Side panel – upholstered outside, laminated inside
CAL 133, add \$204 List per chair

COM 3.75 yds
0.75 yd COM per single seat / 1.0 yd COM per single back / 1.0 yd COM per panel

| MODEL | COM | GR 1 | GR 2 | GR 3 | GR 4 | GR 5 | GR 6 |
|-------------------|-------------|-------------|-------------|-------------|-------------|-------------|-------------|
| 4601M-UU-N | 1684 | 1882 | 1947 | 2077 | 2272 | 2419 | 2616 |

Side panel – upholstered, outside and inside
CAL 133, add \$284 List per chair

Dimensions (inches)

| | | | | | |
|---------|-------|---------|------|-------|------|
| seat H | 18.0 | seat W | 23.0 | arm H | 17.5 |
| total H | 31.75 | total W | 28.5 | depth | 30.0 |

For KYDEX® arms add suffix K and \$262
Dynamic load tested to 500 lbs per chair



4601M-N
90 lbs



BEHAVIORAL HEALTH & HEAVY DUTY Specialty Seating

DIGNITY2

Standard Features

- Separate seat and back
- Arm caps available in wood, or polyurethane
- Laminate or upholstered side panels on inside and outside of arm in various combinations
- Upholstered side panels can match or contrast seat/back
- Select from 15 standard laminates or choose any standard Wilsonart, Nevamar, Formica, Arborite and Pionite matte finish laminates at no upcharge.
- Sculpted steel leg in any Spectone finish
- No protruding legs or hardware
- Tamper proof fastenings
- Non-removable steel levelling glides
- Ships assembled
- Ships 1/carton 15 cu ft

Options

- Polyurethane arm caps available in Black (B) or Taupe RAL 7006 (T) or Sterling Grey (G)
- For wood arm caps, select from 9 standard stains, or stain-to-match at no upcharge
- KYDEX® arm caps available in Black (B) or Taupe RAL 7006 (T) or Sterling Grey (G)
- Thermofoil side panels on inside and outside of arm, call Customer Service for pricing and finishes
- Add up to 20 lbs of additional weight per seat, add \$162 List per seat
- Non-standard laminates, contact Spec for pricing
- Antibacterial and antimicrobial fabrics available
- Floor mounting straps available, call Customer Service
- Connecting and freestanding tables
- CAL 133
- Elimination of separated seat and back available with either solid or perforated seat pan, call Customer Service

Contact Spec Customer Service to railroad fabrics (specify repeat info and yardage requirement will be provided) and for repeats greater than 5" x 5"

Two Seater with no arms

COM 3.5 yds
0.75 yd COM per single seat / 1.0 yd COM per single back

| MODEL | COM | GR 1 | GR 2 | GR 3 | GR 4 | GR 5 | GR 6 |
|-------------------|-------------|-------------|-------------|-------------|-------------|-------------|-------------|
| 4602M-LL-N | 2142 | 2328 | 2388 | 2510 | 2690 | 2829 | 3012 |

Side panel – laminated, outside and inside
CAL 133, add \$240 List per two seater



4602M-N
144 lbs

COM 4.5 yds
0.75 yd COM per single seat / 1.0 yd COM per single back / .5 yd COM per panel

| MODEL | COM | GR 1 | GR 2 | GR 3 | GR 4 | GR 5 | GR 6 |
|-------------------|-------------|-------------|-------------|-------------|-------------|-------------|-------------|
| 4602M-LU-N | 2259 | 2496 | 2573 | 2729 | 2964 | 3142 | 3378 |

Side panel – laminated, outside, upholstered inside
CAL 133, add \$324 List per two seater

COM 4.5 yds
0.75 yd COM per single seat / 1.0 yd COM per single back / .5 yd COM per panel

| MODEL | COM | GR 1 | GR 2 | GR 3 | GR 4 | GR 5 | GR 6 |
|-------------------|-------------|-------------|-------------|-------------|-------------|-------------|-------------|
| 4602M-UL-N | 2259 | 2496 | 2573 | 2729 | 2964 | 3142 | 3378 |

Side panel – upholstered outside, laminated inside
CAL 133, add \$324 List per two seater

COM 5.5 yds
0.75 yd COM per single seat / 1.0 yd COM per single back / 1.0 yd COM per panel

| MODEL | COM | GR 1 | GR 2 | GR 3 | GR 4 | GR 5 | GR 6 |
|-------------------|-------------|-------------|-------------|-------------|-------------|-------------|-------------|
| 4602M-UU-N | 2375 | 2666 | 2759 | 2952 | 3236 | 3453 | 3744 |

Side panel – upholstered, outside and inside
CAL 133, add \$408 List per two seater

Dimensions (inches)

| | | | | | |
|---------|-------|---------|------|-------|------|
| seat H | 18.0 | seat W | 45.0 | arm H | 17.5 |
| total H | 31.75 | total W | 51.0 | depth | 30.0 |

For KYDEX® arms add suffix K and \$262
Dynamic load tested to 750 lbs per two seater



BEHAVIORAL HEALTH & HEAVY DUTY Specialty Seating

DIGNITY2

Standard Features

- Separate seat and back
- Arm caps available in wood, or polyurethane
- Laminate or upholstered side panels on inside and outside of arm in various combinations
- Upholstered side panels can match or contrast seat/back
- Select from 15 standard laminates or choose any standard Wilsonart, Nevamar, Formica, Arborite and Pionite matte finish laminates at no upcharge.
- Sculpted steel leg in any Spectone finish
- No protruding legs or hardware
- Tamper proof fastenings
- Non-removable steel levelling glides
- Ships assembled
- Ships 1/carton 15 cu ft

Options

- Polyurethane arm caps available in Black (B) or Taupe RAL 7006 (T) or Sterling Grey (G)
- For wood arm caps, select from 9 standard stains, or stain-to-match at no upcharge
- KYDEX® arm caps available in Black (B) or Taupe RAL 7006 (T) or Sterling Grey (G)
- Thermofoil side panels on inside and outside of arm, call Customer Service for pricing and finishes
- Add up to 20 lbs of additional weight per seat, add \$162 List per seat
- Non-standard laminates, contact Spec for pricing
- Antibacterial and antimicrobial fabrics available
- Floor mounting straps available, call Customer Service
- Connecting and freestanding tables
- CAL 133
- Elimination of separated seat and back available with either solid or perforated seat pan, call Customer Service

Contact Spec Customer Service to railroad fabrics (specify repeat info and yardage requirement will be provided) and for repeats greater than 5" x 5"

Three Seater with no arms

COM 5.25 yds
0.75 yd COM per single seat / 1.0 yd COM per single back

| MODEL | COM | GR 1 | GR 2 | GR 3 | GR 4 | GR 5 | GR 6 |
|-------------------|-------------|-------------|-------------|-------------|-------------|-------------|-------------|
| 4603M-LL-N | 2834 | 3111 | 3202 | 3385 | 3658 | 3864 | 4139 |

Side panel – laminated, outside and inside
CAL 133, add \$360 List per three seater

COM 6.25 yds
0.75 yd COM per single seat / 1.0 yd COM per single back / .5 yd COM per panel

| MODEL | COM | GR 1 | GR 2 | GR 3 | GR 4 | GR 5 | GR 6 |
|-------------------|-------------|-------------|-------------|-------------|-------------|-------------|-------------|
| 4603M-LU-N | 2950 | 3279 | 3387 | 3606 | 3931 | 4175 | 4503 |

Side panel – laminated, outside, upholstered inside
CAL 133, add \$444 List per three seater

COM 6.25 yds
0.75 yd COM per single seat / 1.0 yd COM per single back / .5 yd COM per panel

| MODEL | COM | GR 1 | GR 2 | GR 3 | GR 4 | GR 5 | GR 6 |
|-------------------|-------------|-------------|-------------|-------------|-------------|-------------|-------------|
| 4603M-UL-N | 2950 | 3279 | 3387 | 3606 | 3931 | 4175 | 4503 |

Side panel – upholstered outside, laminated inside
CAL 133, add \$444 List per three seater

COM 7.25 yds
0.75 yd COM per single seat / 1.0 yd COM per single back / 1.0 yd COM per panel

| MODEL | COM | GR 1 | GR 2 | GR 3 | GR 4 | GR 5 | GR 6 |
|-------------------|-------------|-------------|-------------|-------------|-------------|-------------|-------------|
| 4603M-UU-N | 3066 | 3449 | 3571 | 3826 | 4202 | 4488 | 4868 |

Side panel – upholstered, outside and inside
CAL 133, add \$528 List per three seater

Dimensions (inches)

| | | | | | |
|---------|-------|---------|------|-------|------|
| seat H | 18.0 | seat W | 68.0 | arm H | 17.5 |
| total H | 31.75 | total W | 74.0 | depth | 30.0 |

For KYDEX® arms add suffix K and \$262
Dynamic load tested to 1000 lbs per three seater



4603M-N
199 lbs



BEHAVIORAL HEALTH & HEAVY DUTY Specialty Seating

DIGNITY2

Standard Features

- Separate seat and back
- Arm caps available in wood, or polyurethane
- Laminate or upholstered side panels on inside and outside of arm in various combinations
- Upholstered side panels can match or contrast seat/back
- Select from 15 standard laminates or choose any standard Wilsonart, Nevamar, Formica, Arborite and Pionite matte finish laminates at no upcharge.
- Sculpted steel leg in any Spectone finish
- No protruding legs or hardware
- Tamper proof fastenings
- Non-removable steel levelling glides
- Ships assembled
- Ships 1/carton 15 cu ft

Options

- Polyurethane arm caps available in Black (B) or Taupe RAL 7006 (T) or Sterling Grey (G)
- For wood arm caps, select from 9 standard stains, or stain-to-match at no upcharge
- KYDEX® arm caps available in Black (B) or Taupe RAL 7006 (T) or Sterling Grey (G)
- Thermofoil side panels on inside and outside of arm, call Customer Service for pricing and finishes
- Add up to 20 lbs of additional weight per seat, add \$162 List per seat
- Non-standard laminates, contact Spec for pricing
- Antibacterial and antimicrobial fabrics available
- Floor mounting straps available, call Customer Service
- Connecting and freestanding tables
- CAL 133
- Elimination of separated seat and back available with either solid or perforated seat pan, call Customer Service

Contact Spec Customer Service to railroad fabrics (specify repeat info and yardage requirement will be provided) and for repeats greater than 5" x 5"

Bariatric Single Seater with no arms

COM 3.25 yds
1.5 yd COM per single seat / 1.75 yd COM per single back

| MODEL | COM | GR 1 | GR 2 | GR 3 | GR 4 | GR 5 | GR 6 |
|-------------------|-------------|-------------|-------------|-------------|-------------|-------------|-------------|
| 4601G-LL-N | 1887 | 2058 | 2112 | 2226 | 2395 | 2523 | 2693 |

Side panel – laminated, outside and inside
CAL 133, add \$154 List per chair



4601G-N
108 lbs

COM 4.25 yds
1.5 yd COM per single seat / 1.75 yd COM per single back / .5 yd COM per panel

| MODEL | COM | GR 1 | GR 2 | GR 3 | GR 4 | GR 5 | GR 6 |
|-------------------|-------------|-------------|-------------|-------------|-------------|-------------|-------------|
| 4601G-LU-N | 2002 | 2226 | 2297 | 2445 | 2668 | 2833 | 3058 |

Side panel – laminated, outside, upholstered inside
CAL 133, add \$233 List per chair

COM 4.25 yds
1.5 yd COM per single seat / 1.75 yd COM per single back / .5 yd COM per panel

| MODEL | COM | GR 1 | GR 2 | GR 3 | GR 4 | GR 5 | GR 6 |
|-------------------|-------------|-------------|-------------|-------------|-------------|-------------|-------------|
| 4601G-UL-N | 2002 | 2226 | 2297 | 2445 | 2668 | 2833 | 3058 |

Side panel – upholstered outside, laminated inside
CAL 133, add \$233 List per chair

COM 5.25 yds
1.5 yd COM per single seat / 1.75 yd COM per single back / 1.0 yd COM per panel

| MODEL | COM | GR 1 | GR 2 | GR 3 | GR 4 | GR 5 | GR 6 |
|-------------------|-------------|-------------|-------------|-------------|-------------|-------------|-------------|
| 4601G-UU-N | 2118 | 2394 | 2485 | 2668 | 2941 | 3147 | 3424 |

Side panel – upholstered, outside and inside
CAL 133, add \$312 List per chair

Dimensions (inches)

| | | | | | |
|---------|-------|---------|------|-------|------|
| seat H | 18.0 | seat W | 31.0 | arm H | 17.5 |
| total H | 31.75 | total W | 36.5 | depth | 30.0 |

For KYDEX® arms add suffix K and \$262
Dynamic load tested to 750 lbs per chair



BEHAVIORAL HEALTH & HEAVY DUTY Specialty Seating

DIGNITY2

Standard Features

- Separate seat and back
- Arm caps available in wood, or polyurethane
- Laminate or upholstered side panels on inside and outside of arm in various combinations
- Upholstered side panels can match or contrast seat/back
- Select from 15 standard laminates or choose any standard Wilsonart, Nevamar, Formica, Arborite and Pionite matte finish laminates at no upcharge.
- Sculpted steel leg in any Spectone finish
- No protruding legs or hardware
- Tamper proof fastenings
- Non-removable steel levelling glides
- Ships assembled
- Ships 1/carton 15 cu ft

Options

- Polyurethane arm caps available in Black (B) or Taupe RAL 7006 (T) or Sterling Grey (G)
- For wood arm caps, select from 9 standard stains, or stain-to-match at no upcharge
- KYDEX® end and polyurethane middle arm caps available in Black (B), Taupe RAL 7006 (T), or Sterling Grey (G).
- Thermofoil side panels on inside and outside of arm, call Customer Service for pricing and finishes
- Add up to 20 lbs of additional weight per seat, add \$162 List per seat
- Non-standard laminates, contact Spec for pricing
- Antibacterial and antimicrobial fabrics available
- Floor mounting straps available, call Customer Service
- Connecting and freestanding tables
- CAL 133
- Elimination of separated seat and back available with either solid or perforated seat pan, call Customer Service

Contact Spec Customer Service to railroad fabrics (specify repeat info and yardage requirement will be provided) and for repeats greater than 5" x 5"

Two Seater with half arms

COM 3.5 yds
0.75 yd COM per single seat / 1.0 yd COM per single back

| MODEL | COM | GR 1 | GR 2 | GR 3 | GR 4 | GR 5 | GR 6 |
|-----------------|-------------|-------------|-------------|-------------|-------------|-------------|-------------|
| 4612M-LL | 2582 | 2768 | 2830 | 2950 | 3134 | 3271 | 3454 |

Side panel – laminated, outside and inside
CAL 133, add \$240 List per two seater

COM 5.0 yds
0.75 yd COM per single seat / 1.0 yd COM per single back / .5 yd COM per panel

| MODEL | COM | GR 1 | GR 2 | GR 3 | GR 4 | GR 5 | GR 6 |
|-----------------|-------------|-------------|-------------|-------------|-------------|-------------|-------------|
| 4612M-LU | 2699 | 2961 | 3050 | 3223 | 3486 | 3680 | 3942 |

Side panel – laminated outside, upholstered inside, half arms will be upholstered
CAL 133, add \$576 List per two seater

COM 4.5 yds
0.75 yd COM per single seat / 1.0 yd COM per single back / .5 yd COM per panel

| MODEL | COM | GR 1 | GR 2 | GR 3 | GR 4 | GR 5 | GR 6 |
|-----------------|-------------|-------------|-------------|-------------|-------------|-------------|-------------|
| 4612M-UL | 2699 | 2961 | 3050 | 3223 | 3486 | 3680 | 3942 |

Side panel – upholstered outside, laminated inside, half arms will be laminated
CAL 133, add \$576 List per two seater

COM 6.0 yds
0.75 yd COM per single seat / 1.0 yd COM per single back / 1.0 yd COM per panel

| MODEL | COM | GR 1 | GR 2 | GR 3 | GR 4 | GR 5 | GR 6 |
|-----------------|-------------|-------------|-------------|-------------|-------------|-------------|-------------|
| 4612M-UU | 2816 | 3129 | 3236 | 3443 | 3758 | 3993 | 4307 |

Side panel – upholstered, outside and inside
CAL 133, add \$828 List per two seater

Dimensions (inches)

| | | | | | |
|---------|-------|---------|------|-------|------|
| seat H | 18.0 | seat W | 48.0 | arm H | 26.0 |
| total H | 31.75 | total W | 54.0 | depth | 30.0 |

For KYDEX® arms add suffix K and \$393
Dynamic load tested to 750 lbs per two seater



4612M
153 lbs



BEHAVIORAL HEALTH & HEAVY DUTY Specialty Seating

DIGNITY2

Standard Features

- Separate seat and back
- Arm caps available in wood, or polyurethane
- Laminate or upholstered side panels on inside and outside of arm in various combinations
- Upholstered side panels can match or contrast seat/back
- Select from 15 standard laminates or choose any standard Wilsonart, Nevamar, Formica, Arborite and Pionite matte finish laminates at no upcharge.
- Sculpted steel leg in any Spectone finish
- No protruding legs or hardware
- Tamper proof fastenings
- Non-removable steel levelling glides
- Ships assembled
- Ships 1/carton 15 cu ft

Options

- Polyurethane arm caps available in Black (B) or Taupe RAL 7006 (T) or Sterling Grey (G)
- For wood arm caps, select from 9 standard stains, or stain-to-match at no upcharge
- KYDEX® end and polyurethane middle arm caps available in Black (B), Taupe RAL 7006 (T), or Sterling Grey (G).
- Thermofoil side panels on inside and outside of arm, call Customer Service for pricing and finishes
- Add up to 20 lbs of additional weight per seat, add \$162 List per seat
- Non-standard laminates, contact Spec for pricing
- Antibacterial and antimicrobial fabrics available
- Floor mounting straps available, call Customer Service
- Connecting and freestanding tables
- CAL 133
- Elimination of separated seat and back available with either solid or perforated seat pan, call Customer Service

Contact Spec Customer Service to railroad fabrics (specify repeat info and yardage requirement will be provided) and for repeats greater than 5" x 5"

Three Seater with half arms

COM 5.25 yds
0.75 yd COM per single seat / 1.0 yd COM per single back

| MODEL | COM | GR 1 | GR 2 | GR 3 | GR 4 | GR 5 | GR 6 |
|-----------------|-------------|-------------|-------------|-------------|-------------|-------------|-------------|
| 4613M-LL | 3692 | 3968 | 4061 | 4243 | 4518 | 4722 | 4997 |

Side panel – laminated, outside and inside
CAL 133, add \$360 List per three seater

COM 7.25 yds
0.75 yd COM per single seat / 1.0 yd COM per single back / .5 yd COM per panel

| MODEL | COM | GR 1 | GR 2 | GR 3 | GR 4 | GR 5 | GR 6 |
|-----------------|-------------|-------------|-------------|-------------|-------------|-------------|-------------|
| 4613M-LU | 3808 | 4188 | 4317 | 4569 | 4948 | 5230 | 5611 |

Side panel – laminated outside, upholstered inside, half arms will be upholstered
CAL 133, add \$780 List per three seater

COM 6.25 yds
0.75 yd COM per single seat / 1.0 yd COM per single back / .5 yd COM per panel

| MODEL | COM | GR 1 | GR 2 | GR 3 | GR 4 | GR 5 | GR 6 |
|-----------------|-------------|-------------|-------------|-------------|-------------|-------------|-------------|
| 4613M-UL | 3808 | 4188 | 4317 | 4569 | 4948 | 5230 | 5611 |

Side panel – upholstered outside, laminated inside, half arms will be laminated
CAL 133, add \$780 List per three seater

COM 8.25 yds
0.75 yd COM per single seat / 1.0 yd COM per single back / 1.0 yd COM per panel

| MODEL | COM | GR 1 | GR 2 | GR 3 | GR 4 | GR 5 | GR 6 |
|-----------------|-------------|-------------|-------------|-------------|-------------|-------------|-------------|
| 4613M-UU | 3924 | 4357 | 4503 | 4789 | 5221 | 5541 | 5974 |

Side panel – upholstered, outside and inside
CAL 133, add \$1032 List per three seater

Dimensions (inches)

| | | | | | |
|---------|-------|---------|------|-------|------|
| seat H | 18.0 | seat W | 75.0 | arm H | 26.0 |
| total H | 31.75 | total W | 80.5 | depth | 30.0 |

For KYDEX® arms add suffix K and \$524
Dynamic load tested to 1000 lbs per three seater



4613M
209 lbs



BEHAVIORAL HEALTH & HEAVY DUTY Specialty Seating

DIGNITY2

Standard Features

- Tamper proof fastenings

To order full panel side panels, add ZC-LL, or ZC-U to model number, e.g. 4601M-ZC-LL

To order wall-saving side panels, add WS-LL or WS-U to the model number, e.g. 4601M-WS-U

Pricing is for entire chair (2 end side panels).

Contact Spec Customer Service to railroad fabrics (specify repeat info and yardage requirement will be provided) and for repeats greater than 5" x 5"

Options

- Thermofoil side panels on inside and outside of arm, call Customer Service for pricing and finishes
- Floor mounting straps available, call Customer Service

Extended Side Panels

Laminate Panels Inside & Outside

| MODEL | LIST |
|-------|------|
| ZC-LL | 85 |

Laminate & Upholstered Combination Panels

COM 0.5 yd per panel

| MODEL | COM | GR 1 | GR 2 | GR 3 | GR 4 | GR 5 | GR 6 |
|-------|-----|------|------|------|------|------|------|
| ZC-LU | 85 | 96 | 99 | 105 | 114 | 122 | 132 |
| ZC-UL | 85 | 96 | 99 | 105 | 114 | 122 | 132 |

Fully Upholstered Panels

COM 1.5 yd per panel

| MODEL | COM | GR 1 | GR 2 | GR 3 | GR 4 | GR 5 | GR 6 |
|-------|-----|------|------|------|------|------|------|
| ZC-U | 85 | 96 | 99 | 105 | 114 | 122 | 132 |



Side panel extended to floor

Wall-Saving Side Panels

Laminate Panels Inside & Outside

| MODEL | LIST |
|-------|------|
| WS-LL | 138 |

Laminate & Upholstered Combination Panels

COM 1.0 yd per panel

| MODEL | COM | GR 1 | GR 2 | GR 3 | GR 4 | GR 5 | GR 6 |
|-------|-----|------|------|------|------|------|------|
| WS-LU | 138 | 269 | 305 | 367 | 476 | 555 | 634 |
| WS-UL | 138 | 269 | 305 | 367 | 476 | 555 | 634 |

Fully Upholstered Panels

COM 2.0 yd per panel

| MODEL | COM | GR 1 | GR 2 | GR 3 | GR 4 | GR 5 | GR 6 |
|-------|-----|------|------|------|------|------|------|
| WS-U | 138 | 269 | 305 | 367 | 476 | 555 | 634 |



Wall-saving side panels



BEHAVIORAL HEALTH & HEAVY DUTY Specialty Seating DIGNITY2

Standard Features

- Black finish only
- 6" soft wheel casters
- Standard Dolly holds 1 single seat chair
- Ships 1/carton, 17 cu. ft.
- Ships assembled



Dignity2 - Dolly

| Description | Model | Price | Weight |
|-------------------|----------------|------------|--------|
| Single Seat Dolly | DIGN-99 | 557 | 12lb |

Dimensions (inches)

| | |
|--------|------|
| height | 39.0 |
| width | 23.0 |
| depth | 30.0 |





BEHAVIORAL HEALTH & HEAVY DUTY Specialty Seating HARDI

Standard Features

- Single roto-molded design
- CAL 133 compliant
- Select from 6 standard colors, which have been selected from our palette of standard Spectone finishes
- No protruding legs or hardware
- Standard without glides
- Dining ships 1/carton 14 cu ft, Lounge ships 1/carton 16 cu ft
- Removable threaded cap is fastened with tamperproof fasteners. Sand (not included) can be added on site for additional weight and ballast utilizing the plastic bag from packaging. Contact Customer Service for more information



Options

- Four nickel-plated non-removable nylon glides secured with LOCTITE®, add \$20 List
- Ganging is available. Please specify a set of nickel-plated non-removable nylon glides secured with LOCTITE for each chair that you want to gang together (\$20 List per chair), and add Q-1 ganging kits (\$36 List). In other words, to gang 9 chairs together, please order 9 sets of glides and 8 ganging kits.
- Floor mounting is available. Please specify a set of nickel-plated non-removable nylon glides secured with LOCTITE for each chair that you want to mount to the floor (\$20 List per chair), and add the same amount of floor mounting kits (\$36 List). In other words, to floor mount 9 chairs, please order 9 sets of glides and 9 floor mounting kits.

Dining

| MODEL | Price |
|-------------|------------|
| 8701 | 584 |
| 8708 | 659 |

Dimensions (inches)

| | | | | | | | |
|--------|------|-------------------|------|----------------|------|---------|------|
| seat H | 18.0 | seat W | 20.0 | arm H | 26.0 | total H | 33.0 |
| depth | 24.0 | total W (no arms) | 22.0 | total W (arms) | 24.0 | | |

Exceeds BIFMA Seating Durability Test to 500 lbs



8701
Without arms
23 lbs



8708
With arms
28 lbs

Lounge

| MODEL | Price |
|-------------|------------|
| 8801 | 631 |
| 8808 | 738 |

Dimensions (inches)

| | | | | | | | |
|--------|-------|-------------------|------|----------------|------|---------|-------|
| seat H | 17.25 | seat W | 23.0 | arm H | 25.0 | total H | 29.50 |
| depth | 27.0 | total W (no arms) | 26.0 | total W (arms) | 27.0 | | |

Exceeds BIFMA Seating Durability Test to 500 lbs



8801
Without arms
25 lbs



8808
With arms
31 lbs



BEHAVIORAL HEALTH & HEAVY DUTY Specialty Seating HARDI

Standard Features

- Single roto-molded design
- CAL 133 compliant
- Select from 6 standard colors, which have been selected from our palette of standard Spectone finishes
- No protruding legs or hardware
- Rocker ships 1/carton 26 cu ft
- Removable threaded cap is fastened with tamperproof fasteners. Sand (not included) can be added on site for additional weight and ballast utilizing the plastic bag from packaging. Contact Customer Service for more information



Rocker

| MODEL | Price |
|-------------|-------------|
| 8840 | 1258 |

Dimensions (inches)

| | | | | | | | |
|--------|-------|---------|------|-------|------|---------|------|
| seat H | 18.25 | seat W | 20.0 | arm H | 25.0 | total H | 37.5 |
| depth | 33.75 | total W | 28.0 | | | | |

Exceeds BIFMA Seating Durability Test to 500 lbs



8840
36 lbs



BEHAVIORAL HEALTH & HEAVY DUTY Specialty Seating HARDI

Standard Features

- Single roto-molded design
- CAL 133 compliant
- Select from 6 standard colors, which have been selected from our palette of standard Spectone finishes
- No protruding legs or hardware
- Standard without glides
- Stool ships 1/carton 4 cu ft
- Removable threaded cap is fastened with tamperproof fasteners. Sand (not included) can be added on site for additional weight and ballast utilizing the plastic bag from packaging. Contact Customer Service for more information

Options

- Nickel-plated non-removable nylon glides secured with LOCTITE®, add \$20 List
- Floor mounting is available. Please specify a set of nickel-plated non-removable nylon glides secured with LOCTITE for each stool that you want to mount to the floor (\$20 List per stool), and add the same amount of floor mounting kits (\$36 List). In other words, to floor mount 9 stools, please order 9 sets of glides and 9 floor mounting kits.



Stool

| MODEL | Price |
|-------------|------------|
| 8901 | 417 |

Dimensions (inches)

| | | | |
|---------|------|---------|------|
| seat H | 18.0 | seat W | 16.0 |
| total H | 18.0 | total W | 17.5 |

Exceeds BIFMA Seating Durability Test to 500 lbs



8901
10 lbs



BEHAVIORAL HEALTH & HEAVY DUTY Specialty Seating HARDI

Standard Features

- Single roto-molded design
- Select from 6 standard colors, which have been selected from our palette of standard Spectone finishes
- No protruding legs or hardware
- Standard without glides
- Ships 1/carton 6 cu ft
- Removable threaded cap is fastened with tamperproof fasteners. Sand (not included) can be added on site for additional weight and ballast utilizing the plastic bag from packaging. Contact Customer Service for more information

Options

- Nickel-plated non-removable nylon glides secured with LOCTITE®, add \$20 List
- Floor mounting is available. Please specify a set of nickel-plated non-removable nylon glides secured with LOCTITE for each chair that you want to mount to the floor (\$20 List per chair), and add the same amount of floor mounting kits (\$36 List). In other words, to floor mount 9 chairs, please order 9 sets of glides and 9 floor mounting kits.



Children's Dining

| | |
|-------------|------------|
| MODEL | Price |
| 8702 | 550 |

Dimensions (inches)

| | | | | | |
|--------|------|-------------------|------|---------|------|
| seat H | 15.0 | seat W | 18.0 | total H | 27.0 |
| depth | 20.5 | total W (no arms) | 18.0 | | |

Exceeds BIFMA Seating Durability Test to 500 lbs



8702
Without arms
15.5 lbs



BEHAVIORAL HEALTH & HEAVY DUTY Specialty Seating MIDWAY HD

Standard Features

- Separate seat and back
- Polyurethane arms or wood arms
- Fully welded 1.25" frame with glides
- Added weight, Sled base
- Frame in any Spectone color
- Steel glides secured with LOCTITE®
- Tamperproof hardware
- Zippered covers glued shut, pulls removed
- Ships assembled
- Ships 1/carton 17 cu ft

Options

- Polyurethane arms available in Black, Sterling Grey or Taupe (RAL 7006)
- Wood arms in Natural Maple are available in any of 9 standard stains or stain-to-match at no up charge
- Floor mounting glides, add \$48 List/chair
- Antibacterial and antimicrobial fabrics available
- Different fabric on seat and back at no upcharge
- CAL 133

Contact Spec™ Customer Service to railroad fabrics (specify repeat info and yardage requirement will be provided) and for repeats greater than 5" x 5"



Midway HD Single Seater with arms – Sled Base

COM 1.5 yds
0.5 yd COM per single seat
1.0 yd COM per single back

| MODEL | COM | GR 1 | GR 2 | GR 3 | GR 4 | GR 5 | GR 6 |
|----------------|-------------|-------------|-------------|-------------|-------------|-------------|-------------|
| 3201UHD | 1376 | 1487 | 1526 | 1598 | 1709 | 1794 | 1907 |

Dimensions (inches)

| | | | | | |
|---------|------|---------|-------|-------|------|
| seat H | 18.0 | seat W | 20.5 | arm H | 26.0 |
| total H | 36.0 | total W | 23.75 | depth | 26.0 |

Exceeds BIFMA Seating Durability Test to 500 lbs per seat
CAL 133, add \$120 List per seat



3201UHD
48 lbs

Midway HD Highback with arms – Sled Base

COM 1.6 yds
0.5 yd COM per single seat
1.1 yds COM per single back

| MODEL | COM | GR 1 | GR 2 | GR 3 | GR 4 | GR 5 | GR 6 |
|----------------|-------------|-------------|-------------|-------------|-------------|-------------|-------------|
| 3201HHD | 1494 | 1609 | 1649 | 1723 | 1838 | 1926 | 2042 |

Dimensions (inches)

| | | | | | |
|---------|------|---------|-------|-------|------|
| seat H | 18.0 | seat W | 20.5 | arm H | 26.0 |
| total H | 46.0 | total W | 23.75 | depth | 26.0 |

Exceeds BIFMA Seating Durability Test to 500 lbs per seat
CAL 133, add \$150 List per chair



3201HHD
50 lbs



BEHAVIORAL HEALTH & HEAVY DUTY Specialty Seating MIDWAY HD

Standard Features

- Separate seat and back
- Polyurethane arms or wood arms
- Fully welded 1.25" frame with glides
- Added weight, Sled base
- Frame in any Spectone color
- Steel glides secured with LOCTITE®
- Tamperproof hardware
- Zippered covers glued shut, pulls removed
- Ships assembled
- Ships 1/carton 17 cu ft

Options

- Polyurethane arms available in Black, Sterling Grey or Taupe (RAL 7006)
- Wood arms in Natural Maple are available in any of 9 standard stains or stain-to-match at no up charge
- Floor mounting glides, add \$48 List/chair
- Antibacterial and antimicrobial fabrics available
- Different fabric on seat and back at no upcharge
- CAL 133

Contact Spec Customer Service to railroad fabrics (specify repeat info and yardage requirement will be provided) and for repeats greater than 5" x 5"



Midway HD Bariatric with arms – Sled Base

COM 2.55 yds
0.8 yd COM per single seat
1.75 yd COM per single back

| MODEL | COM | GR 1 | GR 2 | GR 3 | GR 4 | GR 5 | GR 6 |
|----------------|-------------|-------------|-------------|-------------|-------------|-------------|-------------|
| 3201GHD | 1792 | 1954 | 2010 | 2116 | 2279 | 2402 | 2568 |

Dimensions (inches)

| | | | | | |
|---------|------|---------|-------|-------|------|
| seat H | 18.0 | seat W | 30.0 | arm H | 26.0 |
| total H | 36.0 | total W | 32.75 | depth | 26.0 |

Exceeds BIFMA Seating Durability Test to 750 lbs per seat
CAL 133, add \$205 List per seat



3201GHD
56 lbs



BEHAVIORAL HEALTH & HEAVY DUTY Specialty Seating

SNOWBALL 2 HD

Standard Features

- 0.875" frame
- Added weight, Sled base
- Frame in any Spectone color
- Steel glides secured with LOCTITE®
- Tamperproof hardware
- Does not stack
- Ships 1/carton 11 cu ft
- Staples on the bottom of the seat are covered by a 100% recycled plastic seat pan

Options

- Floor mounting glides, add \$48 List/chair
- CAL 133

Contact Spec Customer Service to railroad fabrics (specify repeat info and yardage requirement will be provided) and for repeats greater than 5" x 5"



Snowball 2 HD Armless – Sled Base

COM 1.0 yd
0.5 yd COM per single seat
0.5 yd COM per single back

| MODEL | COM | GR 1 | GR 2 | GR 3 | GR 4 | GR 5 | GR 6 |
|---------------|------------|------------|------------|------------|------------|------------|------------|
| 1891HD | 659 | 714 | 734 | 772 | 826 | 868 | 925 |

Dimensions (inches)

| | | | | | |
|---------|------|---------|-------|-------|------|
| seat H | 18.0 | seat W | 18.5 | depth | 21.5 |
| total H | 33.0 | total W | 20.25 | | |

Exceeds BIFMA Seating Durability Test to 500 lbs per chair
CAL 133, add \$62 List per chair
1" extra seat foam, specify and add \$15 List



1891HD
44 lbs

Snowball 2 HD with Steel Arms – Sled Base

COM 1.0 yd
0.5 yd COM per single seat
0.5 yd COM per single back

| MODEL | COM | GR 1 | GR 2 | GR 3 | GR 4 | GR 5 | GR 6 |
|---------------|------------|------------|------------|------------|------------|------------|------------|
| 1881HD | 705 | 759 | 779 | 816 | 870 | 914 | 969 |

Dimensions (inches)

| | | | | | |
|---------|------|---------|------|-------|------|
| seat H | 18.0 | seat W | 18.5 | depth | 21.5 |
| total H | 33.0 | total W | 23.5 | | |

Exceeds BIFMA Seating Durability Test to 500 lbs per chair
CAL 133, add \$62 List per chair
1" extra seat foam, specify and add \$15 List



1881HD
45 lbs



BEHAVIORAL HEALTH & HEAVY DUTY Specialty Seating TAILOR HD

Standard Features

- Separate seat and back
- A single-piece metal pan is welded to the frame, covering the underside of both seat and back, and therefore eliminating pass-through. Perforations in the metal pan allow for drainage
- Wall-saving frame
- Roto-molded foot in RAL 7037
- Exposed frame detail is standard in RAL 7037
- Tamper proof fastenings
- Ships assembled
- Ships 1 single seat per carton, 24 cu ft
- Ships 1 bariatric seat per carton, 32 cu ft

Options

- Polyurethane arm caps available in Black (B), Taupe RAL 7006 (T) or Sterling Grey (G), add \$118 List per arm
- Nickel-plated non-removable nylon glides secured with LOCTITE®, add \$20 List
- Floor mounting straps available, call Customer Service
- Up to 40 lbs of additional weight per seat is available, call Customer Service
- Upholstered arms/seat/back can match or contrast
- Antibacterial and antimicrobial fabrics available
- CAL 133

Contact Spec Customer Service to railroad fabrics (specify repeat info and yardage requirement will be provided) and for repeats greater than 5" x 5"



Tailor HD Single Seat With Arms

COM 4.75 yds
1.25 yds COM per single seat
1.5 yds COM per single back
1.0 yds COM per arm

| MODEL | COM | GR 1 | GR 2 | GR 3 | GR 4 | GR 5 | GR 6 |
|----------------|-------------|-------------|-------------|-------------|-------------|-------------|-------------|
| 9101MHD | 1828 | 2100 | 2189 | 2376 | 2653 | 2864 | 3145 |

Dimensions (inches)

| | | | | | |
|---------|------|---------|------|---------|------|
| seat H | 18.0 | seat W | 23.0 | arm H | 24.5 |
| total H | 33.0 | total W | 29.0 | total D | 30.0 |

CAL 133, add \$361 List per unit
Exceeds BIFMA Seating Durability Test to 750 lbs per single seater



9101MHD
119 lbs

Tailor HD Bariatric With Arms

COM 5.5 yds
1.5 yds COM per single seat
2.0 yds COM per single back
1.0 yds COM per arm

| MODEL | COM | GR 1 | GR 2 | GR 3 | GR 4 | GR 5 | GR 6 |
|----------------|-------------|-------------|-------------|-------------|-------------|-------------|-------------|
| 9101GHD | 2032 | 2349 | 2453 | 2673 | 2996 | 3243 | 3571 |

Dimensions (inches)

| | | | | | |
|---------|------|---------|------|---------|------|
| seat H | 18.0 | seat W | 30.0 | arm H | 24.5 |
| total H | 33.0 | total W | 36.0 | total D | 30.0 |

CAL 133, add \$419 List per unit
Exceeds BIFMA Seating Durability Test to 750 lbs per bariatric chair



9101GHD
133 lbs



BEHAVIORAL HEALTH & HEAVY DUTY Specialty Seating TAILOR HD

Standard Features

- Separate seat and back
- A single-piece metal pan is welded to the frame, covering the underside of both seat and back, and therefore eliminating pass-through. Perforations in the metal pan allow for drainage
- Wall-saving frame
- Roto-molded foot in RAL 7037
- Exposed frame detail is standard in RAL 7037
- Tamper proof fastenings
- Ships assembled
- Ships 1 two seat per carton, 43 cu ft
- Ships 1 three seat per carton, 62 cu ft

Options

- Polyurethane arm caps available in Black (B), Taupe RAL 7006 (T) or Sterling Grey (G), add \$118 List per arm
- Nickel-plated non-removable nylon glides secured with LOCTITE®, add \$20 List
- Floor mounting straps available, call Customer Service
- Up to 40 lbs of additional weight per seat is available, call Customer Service
- Upholstered arms/seat/back can match or contrast
- Antibacterial and antimicrobial fabrics available
- CAL 133

Contact Spec Customer Service to railroad fabrics (specify repeat info and yardage requirement will be provided) and for repeats greater than 5" x 5"



Tailor HD Two Seat With Arms

COM 7.5 yds
 2.5 yds COM per two seater one-piece seat
 3.0 yds COM per two seater two-piece back (1.5 yds COM per single back)
 1.0 yds COM per arm

| MODEL | COM | GR 1 | GR 2 | GR 3 | GR 4 | GR 5 | GR 6 |
|----------------|-------------|-------------|-------------|-------------|-------------|-------------|-------------|
| 9102MHD | 2686 | 3109 | 3247 | 3538 | 3968 | 4295 | 4732 |

Dimensions (inches)

| | | | | | |
|---------|------|---------|------|---------|------|
| seat H | 18.0 | seat W | 23.0 | arm H | 24.5 |
| total H | 33.0 | total W | 52.0 | total D | 30.0 |

CAL 133, add \$570 List per unit
 Exceeds BIFMA Seating Durability Test to 450 lbs per two seater



9102MHD
175 lbs

Tailor HD Three Seat With Arms

COM 10.25 yds
 3.75 yds COM per three seater one-piece seat
 4.5 yds COM per three seater three-piece back (1.5 yds COM per single back)
 1.0 yds COM per arm

| MODEL | COM | GR 1 | GR 2 | GR 3 | GR 4 | GR 5 | GR 6 |
|----------------|-------------|-------------|-------------|-------------|-------------|-------------|-------------|
| 9103MHD | 3586 | 4159 | 4347 | 4742 | 5326 | 5771 | 6364 |

Dimensions (inches)

| | | | | | |
|---------|------|---------|------|---------|------|
| seat H | 18.0 | seat W | 23.0 | arm H | 24.5 |
| total H | 33.0 | total W | 75.0 | total D | 30.0 |

CAL 133, add \$779 List per unit
 Exceeds BIFMA Seating Durability Test to 675 lbs per three seater



9103MHD
231 lbs



BEHAVIORAL HEALTH & HEAVY DUTY Specialty Seating TRAFFIC DINING

Standard Features

- Tabletop standard in Laminate with PVC Flat (PVF), 2MM or Self Edge (SE)
- Select from 15 standard laminates or choose any standard Wilsonart, Nevamar, Formica, Arborite and Pionite matte finish laminates at no upcharge. For other laminate please contact the factory for pricing.
- PVC Flat edge and 2mm Bio edge available in 38 solid colors. 2mm PVC edge available in wood grain to match 9 standard stains.
- Floor Mounting plates
- Tamperproof fasteners
- Welded steel end caps

Options

- 30" Bariatric seats are available. Contact factory for pricing
- Coated steel tabletop available. Contact factory for pricing
- CAL 133

Contact Spec Customer Service to railroad fabrics (specify repeat info and yardage requirement will be provided) and for repeats greater than 5" x 5"



Traffic Dining without arms, without upholstered cushions

N/A COM per single seat

| MODEL | PRICE |
|---------|-------|
| 7100NHD | 4920 |

Dimensions (inches)

| | | | | | | | |
|---------|-------|---------|------|------------|-------|-------------|------|
| seat H | 18.0 | seat W | 22.0 | table top | 30x48 | table H | 29.0 |
| total H | 33.75 | total W | 48.0 | seat depth | 17.0 | total depth | 74 |

Exceeds BIFMA Seating Durability Test to 500 lbs per chair

Traffic Dining without arms, with upholstered cushions

0.75 yd COM per single seat and back

| MODEL | COM | GR 1 | GR 2 | GR 3 | GR 4 | GR 5 | GR 6 |
|---------|------|------|------|------|------|------|------|
| 7100UHD | 4999 | 5167 | 5223 | 5365 | 5535 | 5665 | 5832 |

Dimensions (inches)

| | | | | | | | |
|---------|-------|---------|------|------------|-------|-------------|------|
| seat H | 18.0 | seat W | 22.0 | table top | 30x48 | table H | 29.0 |
| total H | 33.75 | total W | 48.0 | seat depth | 17.0 | total depth | 74 |

Exceeds BIFMA Seating Durability Test to 500 lbs per chair
CAL 133, add \$240 List per unit





BEHAVIORAL HEALTH & HEAVY DUTY Specialty Seating

1000 SERIES HD

Standard Features

- One piece seat and back
- Fully welded 1.25" frame
- Added weight, Sled base
- Frame in any Spectone color
- Steel glides secured with LOCTITE®
- Tamperproof hardware
- Zippered covers glued shut, pulls removed
- Ships assembled
- Ships 1/carton 15 cu ft

Options

- Floor mounting glides, add \$48 List/chair
- CAL 133

Contact Spec Customer Service to railroad fabrics (specify repeat info and yardage requirement will be provided) and for repeats greater than 5" x 5"



1000 Series HD Armless Medium Back – Sled Base

1.25 yds COM per single seat and back

| MODEL | COM | GR 1 | GR 2 | GR 3 | GR 4 | GR 5 | GR 6 |
|---------------|-------------|-------------|-------------|-------------|-------------|-------------|-------------|
| 1014HD | 1103 | 1180 | 1199 | 1246 | 1316 | 1370 | 1440 |

Dimensions (inches)

| | | | | | |
|---------|------|---------|------|-------|------|
| seat H | 18.0 | seat W | 18.5 | depth | 22.0 |
| total H | 33.0 | total W | 18.5 | | |

Exceeds BIFMA Seating Durability Test to 500 lbs per chair
 CAL 133, add \$80 List per chair



1014HD
46 lbs



BEHAVIORAL HEALTH & HEAVY DUTY Specialty Seating 2000 SERIES HD

Standard Features

- Fully welded 1.5" frame
- Added weight, Sled base
- Frame in any Spectone color
- Steel glides secured with LOCTITE®
- Tamperproof hardware
- Zippered covers glued shut, pulls removed
- Ships assembled
- Ships 1/carton 17 cu ft

Options

- Floor mounting glides, add \$48 List/chair
- CAL 133

Contact Spec Customer Service to railroad fabrics (specify repeat info and yardage requirement will be provided) and for repeats greater than 5" x 5"



2000 Series HD One Piece Single Seater with arms – Sled Base

COM 1.75 yds
1.75 yd COM per single seat and back

| MODEL | COM | GR 1 | GR 2 | GR 3 | GR 4 | GR 5 | GR 6 |
|----------------|-------------|-------------|-------------|-------------|-------------|-------------|-------------|
| 2201CHD | 1163 | 1251 | 1282 | 1344 | 1432 | 1501 | 1593 |

Dimensions (inches)

| | | | | | |
|---------|------|---------|------|-------|------|
| seat H | 18.0 | seat W | 22.0 | arm H | 26.0 |
| total H | 35.0 | total W | 25.0 | depth | 26.5 |

Exceeds BIFMA Seating Durability Test to 500 lbs per seat
CAL 133, add \$108 List per seat



2201CHD
67 lbs

2000 Series HD Separate Seat and Back with arms – Sled Base

COM 1.75 yds
1.0 yd COM per single seat
0.75 yd COM per single back

| MODEL | COM | GR 1 | GR 2 | GR 3 | GR 4 | GR 5 | GR 6 |
|-----------------|-------------|-------------|-------------|-------------|-------------|-------------|-------------|
| 2201CHDS | 1366 | 1455 | 1485 | 1544 | 1635 | 1705 | 1795 |

Dimensions (inches)

| | | | | | |
|---------|------|---------|------|-------|------|
| seat H | 18.0 | seat W | 22.0 | arm H | 26.0 |
| total H | 35.0 | total W | 25.0 | depth | 26.5 |

Exceeds BIFMA Seating Durability Test to 500 lbs per seat
CAL 133, add \$108 List per chair



2201CHDS
67 lbs

JAZZY



PRODUCT CODE

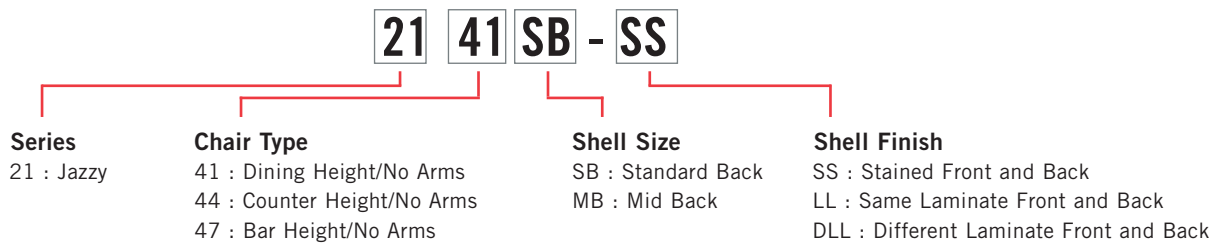

STANDARD OPTIONS

| | | | | |
|--|--|--|---|---|
| <p>GLIDE</p>  <p>Clear Glide</p> | <p>STACKING</p>  <p>Jazzy Dining and Counter Heights</p> | <p>GLIDE</p>  <p>Clear Glide with Felt</p> | <p>SHELL FINISH</p>  <p>Stained Front & Back Laminate Front & Back</p> | <p>DOLLY</p>  |
|--|--|--|---|---|

FINISHES

LAMINATE SHELL



Choose any standard postform grade, non high-gloss Wilsonart, Formica or Arborite laminates at no upcharge.

STAIN SHELL



Select clear maple shell finish or one of our 9 standard wood stains at no upcharge.

FRAME



Select from one of our 76 standard Spectone colors. Chrome is also available.











JAZZY

MAPLE PLY SHELL FINISHES

STAINS











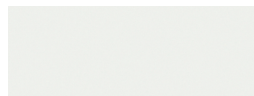

Available in clear maple shell finish or one of our 9 standard wood stains. For custom stains please call Customer Service.

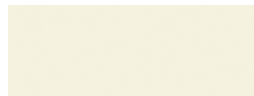
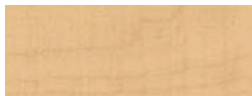
| | | | | |
|--|---|--|---|---|
|  |  |  |  |  |
| Fusion Maple Stain Best Laminate Match: Fusion Maple Wilsonart 7909-60 | Walnut Heights Stain Best Laminate Match: Walnut Heights Wilsonart 7965K-78 | Wild Cherry Stain Best Laminate Match: Wild Cherry Wilsonart 7054-60 | Studio Teak Stain Best Laminate Match: Studio Teak Wilsonart 7960K-18 | Empire Mahogany Stain Best Laminate Match: Empire Mahogany Wilsonart 7122K-78 |
|  |  |  |  | |
| New Age Oak Stain Best Laminate Match: New Age Oak Wilsonart 7938-38 | Cafelle Stain Best Laminate Match: Cafelle Wilsonart 7933K-07 | River Cherry Stain Best Laminate Match: River Cherry Wilsonart 7937-38 | Asian Night Stain Best Laminate Match: Asian Night Wilsonart 7949K-18 | |



LAMINATES

Available in postform grade, non high-gloss Wilsonart, Formica and Arborite laminates at no upcharge.

| | | | | |
|---|---|---|---|---|
|  |  |  |  |  |
| Designer White Wilsonart D354-60 | Black Wilsonart 1595-60 | Dove Grey Wilsonart D92-60 | Carbon Mesh Wilsonart 4880-38 | Shadow Wilsonart D96-60 |
|  |  |  |  |  |
| Antique White Wilsonart 1572-60 | Fusion Maple Wilsonart 7909-60 | New Age Oak Wilsonart 7938-38 | Wild Cherry Wilsonart 7054-60 | Walnut Heights Wilsonart 7965K-78 |
|  |  |  |  |  |
| Empire Mahogany Wilsonart 7122K-78 | Cafelle Wilsonart 7933K-38 | River Cherry Wilsonart 7937-38 | Studio Teak Wilsonart 7960K-18 | Asian Night Wilsonart 7949K-18 |

For other laminates, please visit manufacturers' websites and select from the grades and finishes below:

| | Grade | Finish |
|-----------|----------------|---|
| Arborite | VGP (0.028" t) | -CA; -EV; -SR; -T |
| Formica | Grade 20 | -58, -NT, -42, -46, -RD, -JN, -34, -NG, -WR |
| Wilsonart | Grade 335 | -38, -60, -12, -16, -18, -28, -78 |

JAZZY

HOW TO ORDER



Specify Model

- A** Specify Shell Finish

For Stained Shell: Wood Stain

For Same Laminate Front & Back Shell: Manufacturer, Laminate Name, Laminate Code

For Different Laminate Front & Back Shell:

- a) Front: Manufacturer, Laminate Name, Laminate Code*
- b) Back: Manufacturer, Laminate Name, Laminate Code*

- B** Specify Frame Finish

Optional: Dolly, Felt Glides, Chrome Frame, Clear Footrest Protector



| Model | Shell Finish | Frame Finish |
|------------|--|--------------|
| 2147MB-DLL | Different Laminate Front and Back. Front: Formica Stop Red 839-58. Back: Wilsonart Pewter D73-60 | Silver |

JAZZY DIMENSION OVERVIEW



SHELL PROFILE STANDARDS



JAZZY DINING
2141SB



JAZZY COUNTER
2144MB



JAZZY BAR
2147MB

JAZZY DINING HEIGHT

Standard Features

- 0.5" steel wire frame in any Spectone color
- Maple ply shell is available in any postform grade, non high-gloss Wilsonart, Formica or Arborite laminates at no upcharge. For other laminate please contact the factory for pricing. When finished in laminate, maple ply edge is exposed and clear coated.
- Maple ply shell is available in clear finish or 9 standard wood stains. Front, back and exposed edge are finished in the selected stain.
- Ply shell grain runs vertically as standard
- Standard with clear polycarbonate glides
- 18" seat height
- Dining height chair ships with Standard-back (SB) as standard
- Dining height chair stacks 12 high with dolly, 8 without dolly
- Ships assembled 4/carton 15 cu ft
- **For less than 10 chairs of the same shell finish, a \$988 List setup charge applies**

Options

- Same laminate (LL), Different laminate (DLL), or Stained (SS) front and back shell finish
- For custom stain contact Factory. Upcharge or minimum order quantity may apply
- Chrome frame finish, add \$62 List per chair
- Felt glides (FG), add \$10 List per chair
- Jazzy Dolly (2199) available at \$572 List



Jazzy – Dining Height

MODEL Price
2141SB-SS **556**
stained front and back

For less than 10 chairs of the same shell finish, a \$ 988 List setup charge applies.



2141SB
16 lbs

MODEL Price
2141SB-LL **666**
same laminate front and back

For less than 10 chairs of the same shell finish, a \$ 988 List setup charge applies.



MODEL Price
2141SB-DLL **697**
different laminate front and back

For less than 10 chairs of the same shell finish, a \$ 988 List setup charge applies.



Dimensions (inches)
seat H 18.0 seat W 16.0 total H 33.75
depth 20.75 total W 20.75

ANSI/BIFMA X5.1-2017 Compliant. Structural Durability Tested to 275 lbs

JAZZY COUNTER HEIGHT

Standard Features

- 0.5" steel wire frame in any Spectone color
- Maple ply shell is available in any postform grade, non high-gloss Wilsonart, Formica or Arborite laminates at no upcharge. For other laminate please contact the factory for pricing. When finished in laminate, maple ply edge is exposed and clear coated.
- Maple ply shell is available in clear finish or 9 standard wood stains. Front, back and exposed edge are finished in the selected stain.
- Ply shell grain runs vertically as standard
- Standard with clear glides
- Standard with footrest, positioned 10" from the floor
- Counter height is 24" seat height
- Counter height ships with Mid-back (MB) as standard
- Counter height chair stacks 10 high with dolly, 5 without dolly
- Ships assembled 4/carton 18 cu ft
- **For less than 10 chairs of the same shell finish, a \$988 List setup charge applies**

Options

- Same laminate (LL), Different laminate (DLL), or Stained (SS) front and back shell finish
- For custom stain contact Factory. Upcharge or minimum order quantity may apply
- Chrome frame finish, add \$62 List per chair
- Felt glides (FG), add \$10 List per chair
- For clear abrasion-resistant polyurethane film applied over the footrest (FP), add \$16 List
- Jazzy Dolly (2199) available at \$572 List



Jazzy – Counter Height

MODEL Price
2144MB-SS **593**
stained front and back

For less than 10 chairs of the same shell finish, a \$ 988 List setup charge applies.



2144MB
17 lbs

MODEL Price
2144MB-LL **702**
same laminate front and back

For less than 10 chairs of the same shell finish, a \$ 988 List setup charge applies.



MODEL Price
2144MB-DLL **733**
different laminate front and back

For less than 10 chairs of the same shell finish, a \$ 988 List setup charge applies.



Dimensions (inches)
 seat H 24.0 seat W 16.0 total H 33.5
 depth 20.5 total W 21.0

ANSI/BIFMA X5.1-2017 Compliant. Structural Durability Tested to 275 lbs

JAZZY BAR HEIGHT

Standard Features

- 0.5" steel wire frame in any Spectone color
- Maple ply shell is available in any postform grade, non high-gloss Wilsonart, Formica or Arborite laminates at no upcharge. For other laminate please contact the factory for pricing. When finished in laminate, maple ply edge is exposed and clear coated.
- Maple ply shell is available in clear finish or 9 standard wood stains. Front, back and exposed edge are finished in the selected stain.
- Ply shell grain runs vertically as standard
- Standard with clear glides
- Standard with footrest, positioned 10" from the floor
- Bar height is 29" seat height
- Bar height ships with Mid-back (MB) as standard
- Ships assembled 2/carton 18 cu ft
- **For less than 10 chairs of the same shell finish, a \$988 List setup charge applies**

Options

- Same laminate (LL), Different laminate (DLL), or Stained (SS) front and back shell finish
- For custom stain contact Factory. Upcharge or minimum order quantity may apply
- Chrome frame finish, add \$62 List per chair
- Felt glides (FG), add \$10 List per chair
- For clear abrasion-resistant polyurethane film applied over the footrest (FP), add \$16 List

Jazzy – Bar Height

MODEL Price
2147MB-SS **671**
*stained
front and back*

For less than 10 chairs of the same shell finish, a \$ 988 List setup charge applies.

MODEL Price
2147MB-LL **785**
*same laminate
front and back*

For less than 10 chairs of the same shell finish, a \$ 988 List setup charge applies.

MODEL Price
2147MB-DLL **811**
*different laminate
front and back*

For less than 10 chairs of the same shell finish, a \$ 988 List setup charge applies.

Dimensions (inches)
seat H 29.0 seat W 16.0 total H 38.5
depth 20.5 total W 21.0

ANSI/BIFMA X5.1-2017 Compliant. Structural Durability Tested to 275 lbs

2147MB
19 lbs



MIDWAY Public Seating

LAYOUTS



Description

- Spec's high durability public seating in a lighter scale allows specifiers to maximize space requirements.
- Your layout possibilities are unlimited with spacer, radius and corner tables – for both standard and bariatric seating in virtually any combination.
- Bariatric seating is a 30" wide seat and is load tested to 750 lbs. Cannot be connected to other bariatric seats.
- 20.5" seat width is standard.
- Choice of polyurethane or wood arms which are replaceable in the field.
- All models offer a choice of no center arms, half arms or full arms to the floor.
- 1.25" diameter wall-saving frame is standard to protect both wall and fabric.
- Separate seat and back provide exceptional comfort and ease of maintenance.
- Please send a drawing of the configuration you require with your order.
- Optional floor mounting glides available.
- For fabrics you wish railroaded or repeats larger than 5" x 5", please contact the factory with repeat information and yardage requirement will be provided.

LAYOUTS AND DIMENSIONS

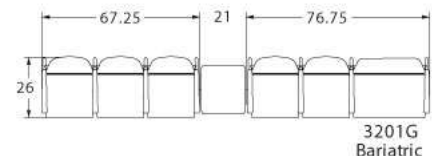
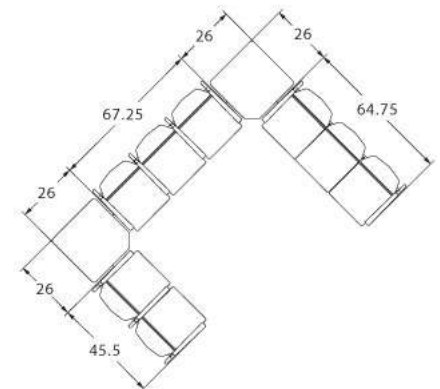
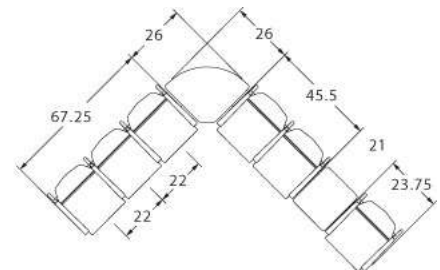

MIDWAY Public Seating



PRODUCT CODE

32 1 2 U

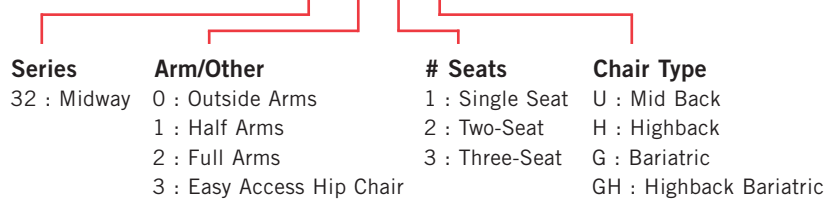

OPTIONS

ARM



Wood



Polyurethane

FINISHES

FRAME



Select from one of our 76 standard Spectone colors

FABRIC



Select fabrics from one of our textile partners

ARMS



Black

Sterling Grey

Taupe

Select from one of our 9 standard wood stains or stain-to-match at no upcharge

See Spectone Card or specfurniture.com/materials/finishes for a complete list of finish options and colors.



MIDWAY Public Seating

HOW TO ORDER



Specify Model

- A** Specify Fabric - Seat¹
Manufacturer, Pattern Name, Color
- B** Specify Fabric - Back¹
Manufacturer, Pattern Name, Color
- C** Specify Frame Finish
- D** Specify Arm Type and Color

Optional: Flex Back, CAL 133, Moisture Barrier, Connecting and Freestanding Tables, Ottoman, Vinyl Headrest Insert

¹ When multiple fabrics are specified on two and three seat chairs, please provide a drawing and legend for fabric placement.



| Model | Fabric - Seat | Fabric - Back | Frame Finish | Arm Type and Color |
|-------|---------------------------|---------------------------|--------------|---------------------|
| 3201U | Momentum, Beeline, Canvas | Momentum, Beeline, Canvas | Silver | Polyurethane, Black |



MIDWAY Public Seating

Single Seater with arms

Standard Features

- Separate seat and back
- Polyurethane arms or wood arms
- Fully welded 1.25" frame with glides
- Frame in any Spectone color
- Velcro removable back covers
- Replaceable seats
- Use in connected layouts at no upcharge
- Arms replaceable in the field
- Ships assembled
- Ships 1/carton 17 cu ft

Options

- Polyurethane arms available in Black, Sterling Grey or Taupe (RAL 7006)
- Wood arms in Natural Maple are available in any of 9 standard stains or stain-to-match at no upcharge
- For Flex back add suffix FB and \$181 List.
Note: Wall-saving frame is not available when Flex back is specified.
- Connected and freestanding tables
- Antibacterial and antimicrobial fabrics available
- Different fabric on seat and back at no upcharge
- CAL 133

Contact Spec™ Customer Service to railroad fabrics (specify repeat info and yardage requirement will be provided) and for repeats greater than 5" x 5"



Single Seater with arms

COM 1.75 yds
0.75 yd COM per single seat
1.0 yd COM per single back

| MODEL | COM | GR 1 | GR 2 | GR 3 | GR 4 | GR 5 | GR 6 |
|--------------|------------|-------------|-------------|-------------|-------------|-------------|-------------|
| 3201U | 979 | 1091 | 1128 | 1201 | 1314 | 1399 | 1510 |

Dimensions (inches)

| | | | | | |
|---------|------|---------|-------|-------|------|
| seat H | 18.0 | seat W | 20.5 | arm H | 26.0 |
| total H | 36.0 | total W | 23.75 | depth | 26.0 |

Exceeds BIFMA Seating Durability Test to 500 lbs per chair
CAL 133, add \$120 List per chair



3201U
30 lbs



MIDWAY Public Seating

Two and Three Seaters with outside arms

Standard Features

- Separate seat and back
- Polyurethane arms or wood arms
- Fully welded 1.25" frame with glides
- Frame in any Spectone color
- Velcro removable back covers
- Replaceable seats
- Use in connected layouts at no upcharge
- Arms replaceable in the field
- Ships assembled
- Ships 1/carton 28 cu ft (2 seater),
1/carton 42 cu ft (3 seater)

Options

- Polyurethane arms available in Black, Sterling Grey or Taupe (RAL 7006)
- Wood arms in Natural Maple are available in any of 9 standard stains or stain-to-match at no up charge
- Connected and freestanding tables
- Antibacterial and antimicrobial fabrics available
- Different fabric on seat and back at no upcharge
- CAL 133

Contact Spec Customer Service to railroad fabrics (specify repeat info and yardage requirement will be provided) and for repeats greater than 5" x 5"



Two Seater with outside arms

COM 3.5 yds
0.75 yd COM per single seat
1.0 yd COM per single back

| MODEL | COM | GR 1 | GR 2 | GR 3 | GR 4 | GR 5 | GR 6 |
|--------------|-------------|-------------|-------------|-------------|-------------|-------------|-------------|
| 3202U | 1566 | 1787 | 1861 | 2009 | 2233 | 2403 | 2626 |

Dimensions (inches)

| | seat H | 18.0 | seat W | 20.5 | arm H | 26.0 |
|---------|--------|---------|--------|-------|-------|------|
| total H | 36.0 | total W | 44.25 | depth | 26.0 | |

Exceeds BIFMA Seating Durability Test to 500 lbs per two seater
CAL 133, add \$240 List per two seater



3202U
56 lbs

Three Seater with outside arms

COM 5.25 yds
0.75 yd COM per single seat
1.0 yd COM per single back

| MODEL | COM | GR 1 | GR 2 | GR 3 | GR 4 | GR 5 | GR 6 |
|--------------|-------------|-------------|-------------|-------------|-------------|-------------|-------------|
| 3203U | 2091 | 2426 | 2538 | 2761 | 3094 | 3349 | 3683 |

Dimensions (inches)

| | seat H | 18.0 | seat W | 20.5 | arm H | 26.0 |
|---------|--------|---------|--------|-------|-------|------|
| total H | 36.0 | total W | 64.75 | depth | 26.0 | |

Exceeds BIFMA Seating Durability Test to 500 lbs per three seater
CAL 133, add \$360 List per three seater



3203U
84 lbs



MIDWAY Public Seating

Two and Three Seaters with half arms

Standard Features

- Separate seat and back
- Polyurethane arms or wood arms
- Fully welded 1.25" frame with glides
- Frame in any Spectone color
- Velcro removable back covers
- Replaceable seats
- Use in connected layouts at no upcharge
- Arms replaceable in the field
- Ships assembled
- Ships 1/carton 28 cu ft (2 seater),
1/carton 42 cu ft (3 seater)

Options

- Polyurethane arms available in Black, Sterling Grey or Taupe (RAL 7006)
- Wood arms in Natural Maple are available in any of 9 standard stains or stain-to-match at no up charge
- Connected and freestanding tables
- Antibacterial and antimicrobial fabrics available
- Different fabric on seat and back at no upcharge
- CAL 133

Contact Spec Customer Service to railroad fabrics (specify repeat info and yardage requirement will be provided) and for repeats greater than 5" x 5"



Two Seater with half arms

COM 3.5 yds
0.75 yd COM per single seat
1.0 yd COM per single back

| MODEL | COM | GR 1 | GR 2 | GR 3 | GR 4 | GR 5 | GR 6 |
|--------------|-------------|-------------|-------------|-------------|-------------|-------------|-------------|
| 3212U | 1757 | 1979 | 2054 | 2205 | 2426 | 2598 | 2819 |

Dimensions (inches)

| | seat H | 18.0 | seat W | 20.5 | arm H | 26.0 |
|---------|--------|---------|--------|-------|-------|------|
| total H | 36.0 | total W | 45.5 | depth | 26.0 | |

Exceeds BIFMA Seating Durability Test to 500 lbs per two seater
CAL 133, add \$240 List per two seater



3212U
58 lbs

Three Seater with half arms

COM 5.25 yds
0.75 yd COM per single seat
1.0 yd COM per single back

| MODEL | COM | GR 1 | GR 2 | GR 3 | GR 4 | GR 5 | GR 6 |
|--------------|-------------|-------------|-------------|-------------|-------------|-------------|-------------|
| 3213U | 2442 | 2776 | 2889 | 3111 | 3447 | 3700 | 4033 |

Dimensions (inches)

| | seat H | 18.0 | seat W | 20.5 | arm H | 26.0 |
|---------|--------|---------|--------|-------|-------|------|
| total H | 36.0 | total W | 67.25 | depth | 26.0 | |

Exceeds BIFMA Seating Durability Test to 500 lbs per three seater
CAL 133, add \$360 List per three seater



3213U
86 lbs



MIDWAY Public Seating

Two and Three Seaters with full arms

Standard Features

- Separate seat and back
- Polyurethane arms or wood arms
- Fully welded 1.25" frame with glides
- Frame in any Spectone color
- Velcro removable back covers
- Replaceable seats
- Use in connected layouts at no upcharge
- Arms replaceable in the field
- Ships assembled
- Ships 1/carton 28 cu ft (2 seater),
1/carton 42 cu ft (3 seater)

Options

- Polyurethane arms available in Black, Sterling Grey or Taupe (RAL 7006)
- Wood arms in Natural Maple are available in any of 9 standard stains or stain-to-match at no upcharge
- Connected and freestanding tables
- Antibacterial and antimicrobial fabrics available
- Different fabric on seat and back at no upcharge
- CAL 133

Contact Spec Customer Service to railroad fabrics (specify repeat info and yardage requirement will be provided) and for repeats greater than 5" x 5"



Two Seater with full arms

COM 3.5 yds
0.75 yd COM per single seat
1.0 yd COM per single back

| MODEL | COM | GR 1 | GR 2 | GR 3 | GR 4 | GR 5 | GR 6 |
|--------------|-------------|-------------|-------------|-------------|-------------|-------------|-------------|
| 3222U | 1813 | 2035 | 2110 | 2260 | 2484 | 2653 | 2877 |

Dimensions (inches)

| | seat H | 18.0 | seat W | 20.5 | arm H | 26.0 |
|---------|--------|---------|--------|-------|-------|------|
| total H | 36.0 | total W | 45.5 | depth | 26.0 | |

Exceeds BIFMA Seating Durability Test to 500 lbs per two seater
CAL 133, add \$240 List per two seater



3222U
60 lbs

Three Seater with full arms

COM 5.25 yds
0.75 yd COM per single seat
1.0 yd COM per single back

| MODEL | COM | GR 1 | GR 2 | GR 3 | GR 4 | GR 5 | GR 6 |
|--------------|-------------|-------------|-------------|-------------|-------------|-------------|-------------|
| 3223U | 2562 | 2894 | 3007 | 3229 | 3563 | 3819 | 4154 |

Dimensions (inches)

| | seat H | 18.0 | seat W | 20.5 | arm H | 26.0 |
|---------|--------|---------|--------|-------|-------|------|
| total H | 36.0 | total W | 67.25 | depth | 26.0 | |

Exceeds BIFMA Seating Durability Test to 500 lbs per three seater
CAL 133, add \$360 List per three seater



3223U
88 lbs



MIDWAY Public Seating

Bariatric Single Seater with arms

Standard Features

- Separate seat and back
- Polyurethane arms or wood arms
- Fully welded 1.25" frame with glides
- Frame in any Spectone color
- Velcro removable back covers
- Replaceable seats
- Use in connected layouts at no upcharge
- Arms replaceable in the field
- Bariatric seating cannot connect to bariatric seating
- Ships assembled
- Bariatric ships 1/carton 22 cu ft

Options

- Polyurethane arms available in Black, Sterling Grey or Taupe (RAL 7006)
- Wood arms in Natural Maple are available in any of 9 standard stains or stain-to-match at no upcharge
- Connected and freestanding tables
- Antibacterial and antimicrobial fabrics available
- Different fabric on seat and back at no upcharge
- CAL 133

Contact Spec Customer Service to railroad fabrics (specify repeat info and yardage requirement will be provided) and for repeats greater than 5" x 5"



Bariatric Single Seater with arms

COM 2.55 yds
 0.8 yd COM per single seat
 1.75 yd COM per single back

| MODEL | COM | GR 1 | GR 2 | GR 3 | GR 4 | GR 5 | GR 6 |
|--------------|-------------|-------------|-------------|-------------|-------------|-------------|-------------|
| 3201G | 1192 | 1347 | 1399 | 1499 | 1653 | 1771 | 1925 |

Dimensions (inches)

| | | | | | |
|---------|------|---------|-------|-------|------|
| seat H | 18.0 | seat W | 30.0 | arm H | 26.0 |
| total H | 36.0 | total W | 32.75 | depth | 26.0 |

Exceeds BIFMA Seating Durability Test to 750 lbs per chair
 CAL 133, add \$175 List per chair



3201G
38 lbs



MIDWAY Public Seating

Highback Single Seater with arms Ottoman

Standard Features

- Separate seat and back
- Polyurethane arms or wood arms
- Fully welded 1.25" frame with glides
- Frame in any Spectone color
- Velcro removable back covers
- Replaceable seats
- Use in connected layouts at no upcharge
- Arms replaceable in the field
- Ships assembled
- Ships 1/carton 19 cu ft
- Ottoman ships 1/carton 5 cu ft

Options

- Polyurethane arms available in Black, Sterling Grey or Taupe (RAL 7006)
- Wood arms in Natural Maple are available in any of 9 standard stains or stain-to-match at no up charge
- For Flex back add suffix FB and \$181 List.
Note: Wall-saving frame is not available when Flex back is specified.
- Vinyl insert on top of the back, add \$44 List/seat back
- Connected and freestanding tables
- Antibacterial and antimicrobial fabrics available
- Different fabric on seat and back at no upcharge
- CAL 133

Contact Spec Customer Service to railroad fabrics (specify repeat info and yardage requirement will be provided) and for repeats greater than 5" x 5"



Highback Single Seater with arms

COM 1.85 yds
0.75 yd COM per single seat
1.1 yds COM per single back

| MODEL | COM | GR 1 | GR 2 | GR 3 | GR 4 | GR 5 | GR 6 |
|--------------|-------------|-------------|-------------|-------------|-------------|-------------|-------------|
| 3201H | 1098 | 1205 | 1240 | 1310 | 1418 | 1497 | 1635 |

Dimensions (inches)

| | seat H | 18.0 | seat W | 20.5 | arm H | 26.0 |
|---------|--------|---------|--------|-------|-------|------|
| total H | 46.0 | total W | 23.75 | depth | 25.0 | |

Exceeds BIFMA Seating Durability Test to 500 lbs per chair
CAL 133, add \$150 List per chair



3201H
32 lbs

Ottoman

0.5 yd COM per ottoman

| MODEL | COM | GR 1 | GR 2 | GR 3 | GR 4 | GR 5 | GR 6 |
|--------------|------------|------------|------------|------------|------------|------------|------------|
| 3230F | 393 | 428 | 441 | 463 | 499 | 526 | 572 |

Ottoman Dimensions (inches)

| H | 11.5 | W | 19.25 | depth | 12.25 |
|---|------|---|-------|-------|-------|
|---|------|---|-------|-------|-------|

CAL 133, add \$42 List



3230F
12 lbs



MIDWAY Public Seating

Highback Bariatric Single Seater with arms

Standard Features

- Separate seat and back
- Polyurethane arms or wood arms
- Fully welded 1.25" frame with glides
- Frame in any Spectone color
- Velcro removable back covers
- Replaceable seats
- Use in connected layouts at no upcharge
- Arms replaceable in the field
- Bariatric seating cannot connect to bariatric seating
- Ships assembled
- Baratric Highback ships 1/carton 26 cu ft

Options

- Polyurethane arms available in Black, Sterling Grey or Taupe (RAL 7006)
- Wood arms in Natural Maple are available in any of 9 standard stains or stain-to-match at no up charge
- Connected and freestanding tables
- Antibacterial and antimicrobial fabrics available
- Different fabric on seat and back at no upcharge
- CAL 133

Contact Spec Customer Service to railroad fabrics (specify repeat info and yardage requirement will be provided) and for repeats greater than 5" x 5"



Highback Bariatric Single Seater with arms

COM 3.0 yds
 0.8 yd COM per single seat
 2.2 yds COM per single back

| MODEL | COM | GR 1 | GR 2 | GR 3 | GR 4 | GR 5 | GR 6 |
|---------------|-------------|-------------|-------------|-------------|-------------|-------------|-------------|
| 3201GH | 1311 | 1488 | 1548 | 1665 | 1844 | 1979 | 2196 |

Dimensions (inches)

| | | | | | |
|---------|------|---------|-------|-------|------|
| seat H | 18.0 | seat W | 30.0 | arm H | 26.0 |
| total H | 46.0 | total W | 32.75 | depth | 26.0 |

Exceeds BIFMA Seating Durability Test to 500 lbs per chair
 CAL 133, add \$217 List per chair



3201GH
40 lbs



MIDWAY Public Seating

Easy Access Hip Single Seater with arms

Standard Features

- Separate seat and back
- Polyurethane arms or wood arms
- Fully welded 1.25" frame with glides
- Frame in any Spectone color
- 24" seat height, no seat pitch (level)
- Footrest which assists entering/exiting chair
- Velcro removable back covers
- Replaceable seats
- Arms replaceable in the field
- Ships assembled
- Ships 1/carton 19 cu ft

Options

- Polyurethane arms available in Black, Sterling Grey or Taupe (RAL 7006)
- Wood arms in Natural Maple are available in any of 9 standard stains or stain-to-match at no up charge
- Antibacterial and antimicrobial fabrics available
- Different fabric on seat and back at no upcharge
- CAL 133

Contact Spec Customer Service to railroad fabrics (specify repeat info and yardage requirement will be provided) and for repeats greater than 5" x 5"



Easy Access Hip Single Seater with arms

COM 1.75 yds
 0.75 yd COM per single seat
 1.0 yd COM per single back

| MODEL | COM | GR 1 | GR 2 | GR 3 | GR 4 | GR 5 | GR 6 |
|-------------|-------------|-------------|-------------|-------------|-------------|-------------|-------------|
| 3231 | 1087 | 1200 | 1238 | 1308 | 1423 | 1507 | 1618 |

Dimensions (inches)

| | | | | | |
|---------|------|---------|-------|-------|------|
| seat H | 24.0 | seat W | 20.5 | arm H | 32.0 |
| total H | 42.0 | total W | 23.75 | depth | 26.0 |

Exceeds BIFMA Seating Durability Test to 500 lbs per chair
 CAL 133, add \$120 List per chair



3231
37 lbs

MIDWAY Public Seating

Freestanding Lounge Tables
 Corner and Spacer Connecting Tables

Standard Features

- Tops in laminate or veneer
- Select laminate tops from 15 standard laminates or choose any standard Wilsonart, Nevamar, Formica, Arborite and Pionite matte finish laminates at no upcharge.
- Freestanding lounge tables available with PVC Flat (PVF), 2mm (2MM), exposed Baltic Birch plywood (PF, PKNR) or hardwood (HB) edge
- Connecting table tops available with PVC Flat (PVF) edge, Self edge (SE) or hardwood (HB) edge
- 9 standard veneer and hardwood edge stains. Stain-to-match available at no upcharge.
- Frame in any Spectone color
- Tops utilize NU Green earth friendly core
- Glides
- 18" height

Options

- Non-standard laminates, contact Spec for pricing
- Custom size spacer tables for restricted spaces
- Other sizes may be available

Radius Corner Tables are recommended for open areas

Freestanding Lounge Tables

| Model | Laminate PVF/SE/2MM | Laminate PF/PKNR/HB | Veneer HB | Weight | Cu.Ft. |
|-----------------|------------------------|------------------------|--------------|--------|--------|
| 32 - 24 x 24 SQ | 682 | 878 | 1032 | 28 | 7.2 |
| 32 - 24 x 48 RE | 844 | 1059 | 1276 | 48 | 18 |
| 32 - 30 x 30 SQ | 789 | 931 | 1097 | 43 | 13.5 |
| 32 - 24 DIA | 651 | 1011 | 1216 | 26 | 7.2 |
| 32 - 30 DIA | 755 | 1110 | 1320 | 40 | 13.5 |



Corner and Spacer Connecting Tables

| Model | Laminate PVF/SE | Weight | Cu.Ft. |
|---|--------------------|--------|--------|
| 32RC - 26 x 26 <i>Radius Corner Table</i> | 704 | 26 | 2 |
| 32SC - 26 x 26 <i>Square Corner Table</i> | 704 | 26 | 2 |
| 32TC45 - 19 x 23 <i>45 degree Corner Table</i> | 704 | 19 | 2 |
| 32ST - 19 x 21 <i>Spacer or End Table</i> | 542 | 19 | 2 |

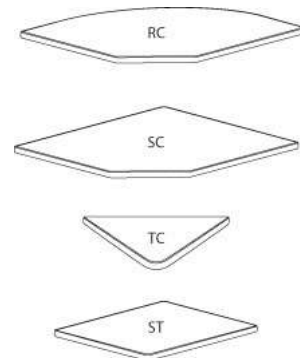



SNOWBALL 1 Public Seating



PRODUCT CODE

18 01

Series

18 : Snowball 1

Chair Type

- | | | | |
|-------------------------|--------------------------|-----------------------|------------------------|
| 01 : Four Point/Arms | 04 : 22"/4-point/Arms | 43 : 26"/Sled/No Arms | 24 : 22"/Stool/Arms |
| 11 : Four Point/No Arms | 14 : 22"/4-Point/No Arms | 02 : Casters/Arms | 26 : 22"/Stool/No Arms |
| 31 : Sled Base/Arms | 03 : 26"/4-Point/Arms | 21 : Stool/Arms | 21E : Hip Chair |
| 41 : Sled Base/No Arms | 44 : 22"/Sled/No Arms | 25 : Stool/No Arms | 24E : 22" Hip Chair |

OPTIONS

WALL-SAVING



DURASPEC SEAT



FINISHES

FRAME



Select from one of our 76 standard Spectone colors

FABRIC



Select fabrics from one of our textile partners

ARMS

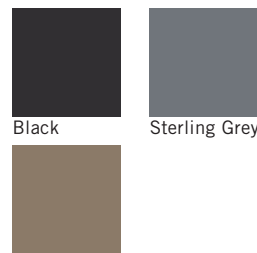

Taupe

See Spectone Card or specfurniture.com/materials/finishes for a complete list of finish options and colors.



SNOWBALL 1 Public Seating

BACK TO CONTENTS

HOW TO ORDER



Specify Model

- A** Specify Fabric - Seat
Manufacturer, Pattern Name, Color
- B** Specify Fabric - Back
Manufacturer, Pattern Name, Color
- C** Specify Frame Finish
- D** Specify Polyurethane Arm Color

Optional: CAL 133, Moisture Barrier, Wall-saving Frame, Connecting Bars, Tablet Arm, Wire Basket, DuraSpec Seat, Connecting Tables, Dolly

Restrictions may apply. See price list tables below for more information.



| Model | Fabric - Seat | Fabric - Back | Frame Finish | Polyurethane Arm Color |
|-------|---------------------------|---------------------------|--------------|------------------------|
| 1801 | Momentum, Beeline, Canvas | Momentum, Beeline, Canvas | Silver | Black |



SNOWBALL 1 Public Seating

Four-point and Sled Base

Standard Features

- 0.875" frame
- Seat and back upholstered
- Polyurethane arms available in Black (B), Sterling Grey (G) or Taupe RAL 7006 (T)
- Frame in any Spectone color
- Four-point stacks 10 high with dolly, 6 without dolly
- Sled Base does not stack and ships 1 per carton
- Ships 1/carton 11 cu ft, 2-4/carton 22 cu ft

Contact Spec Customer Service to railroad fabrics (specify repeat info and yardage requirement will be provided) and for repeats greater than 5" x 5"



Available on Spec 10 Day Program

Options

- Wall-saving frame on Four-point only, add \$22 List
- Connecting bars for a structured reconfigurable layout, add \$85 List
- Antibacterial and antimicrobial fabrics available
- Different fabric on seat and back at no upcharge
- Tablet Arm available on Snowballs without arms
- CAL 133
- Other glides may be available for an upcharge - call Customer Service to inquire
- DuraSpec seat is available on 18"w and 22"w chairs only - call Customer Service for pricing



Optional wall-saving frame



Optional DuraSpec seat

Snowball 1 – Four-point

COM 1.0 yd
0.5 yd COM per single seat
0.5 yd COM per single back

| MODEL | COM | GR 1 | GR 2 | GR 3 | GR 4 | GR 5 | GR 6 |
|-------|-----|------|------|------|------|------|------|
| 1801 | 333 | 383 | 398 | 435 | 485 | 523 | 571 |
| 1811 | 333 | 383 | 398 | 435 | 485 | 523 | 571 |

Dimensions (inches)

| seat H | 18.0 | seat W | 18.0 | arm H | 26.0 | total H | 33.0 |
|--------|------|---------|------|-------------------|------|---------|------|
| depth | 21.5 | total W | 23.5 | total W (no arms) | 20.1 | | |

Exceeds BIFMA Seating Durability Test to 500 lbs
CAL 133, add \$62 List
1" extra seat foam, specify and add \$15 List



1801
With arms
20 lbs



1811
Without arms
19 lbs

Snowball 1 – Sled Base

COM 1.0 yd
0.5 yd COM per single seat
0.5 yd COM per single back

| MODEL | COM | GR 1 | GR 2 | GR 3 | GR 4 | GR 5 | GR 6 |
|-------|-----|------|------|------|------|------|------|
| 1831 | 348 | 397 | 415 | 448 | 498 | 537 | 588 |
| 1841 | 348 | 397 | 415 | 448 | 498 | 537 | 588 |

Dimensions (inches)

| seat H | 18.0 | seat W | 18.0 | arm H | 26.0 | total H | 33.0 |
|--------|------|---------|------|-------------------|------|---------|------|
| depth | 21.5 | total W | 23.5 | total W (no arms) | 20.1 | | |

Exceeds BIFMA Seating Durability Test to 500 lbs
CAL 133, add \$62 List
1" extra seat foam, specify and add \$15 List



1831
With arms
23 lbs



1841
Without arms
22 lbs



SNOWBALL 1 Public Seating

Midsized and Bariatric – Four-point

Standard Features

- 0.875" frame
- Seat and back upholstered
- Polyurethane arms available in Black (B), Sterling Grey (G) or Taupe RAL 7006 (T)
- Frame in any Spectone color
- Four-point stacks 4 high on floor or with dolly
- Ships 1-3/carton 21.24 cu ft for Midsized and 1-3/ carton 24.17 cu ft for Bariatric

Contact Spec Customer Service to railroad fabrics (specify repeat info and yardage requirement will be provided) and for repeats greater than 5" x 5"



Available on Spec 10 Day Program

Options

- Wall-saving frame, add \$22 List
- Connecting bars for a structured reconfigurable layout, add \$85 List
- Antibacterial and antimicrobial fabrics available
- Different fabric on seat and back at no upcharge
- CAL 133
- Other glides may be available for an upcharge - call Customer Service to inquire
- DuraSpec seat is available on 18"w and 22"w chairs only - call Customer Service for pricing



Optional wall-saving frame



Optional DuraSpec seat

Snowball 1 – Midsized – Four-point

COM 1.5 yd
0.75 yd COM per single seat
0.75 yd COM per single back

| MODEL | COM | GR 1 | GR 2 | GR 3 | GR 4 | GR 5 | GR 6 |
|-------|-----|------|------|------|------|------|------|
| 1804 | 381 | 480 | 515 | 580 | 681 | 757 | 858 |
| 1814 | 381 | 480 | 515 | 580 | 681 | 757 | 858 |

*1814 Not Available on 10 Day Program

Dimensions (inches)

| | | | | | | | |
|--------|------|---------|------|-------------------|------|---------|------|
| seat H | 18.0 | seat W | 22.0 | arm H | 26.0 | total H | 33.0 |
| depth | 22.0 | total W | 26.9 | total W (no arms) | 24.0 | | |

Exceeds BIFMA Seating Durability Test to 500 lbs
CAL 133, add \$87 List
1" extra seat foam, specify and add \$23 List



1804
With arms
22 lbs

1814
Without arms
21 lbs

*Not Available on 10 Day Program

Snowball 1 – Bariatric – Four-point

COM 2.0 yd
1.0 yd COM per single seat
1.0 yd COM per single back

| MODEL | COM | GR 1 | GR 2 | GR 3 | GR 4 | GR 5 | GR 6 |
|-------|-----|------|------|------|------|------|------|
| 1803 | 535 | 634 | 668 | 733 | 834 | 911 | 1011 |

Dimensions (inches)

| | | | | | |
|---------|------|---------|------|-------|------|
| seat H | 18.0 | seat W | 26.0 | arm H | 26.0 |
| total H | 33.0 | total W | 31.0 | depth | 22.0 |

Exceeds BIFMA Seating Durability Test to 500 lbs
CAL 133, add \$87 List
1" extra seat foam, specify and add \$32 List



1803
With arms
26 lbs



SNOWBALL 1 Public Seating

Midsized and Bariatric – Sled Base

Standard Features

- 0.875" frame
- Seat and back upholstered
- Frame in any Spectone color
- Does not stack
- Ships 1/carton 21 cu ft

Contact Spec Customer Service to railroad fabrics (specify repeat info and yardage requirement will be provided) and for repeats greater than 5" x 5"

Options

- Connecting bars for a structured reconfigurable layout, add \$85 List
- Antibacterial and antimicrobial fabrics available
- Different fabric on seat and back at no upcharge
- Tablet Arm available on Snowballs without arms
- CAL 133
- Other glides may be available for an upcharge - call Customer Service to inquire
- DuraSpec seat is available on 18"w and 22"w chairs only - call Customer Service for pricing.



Optional DuraSpec seat

Snowball 1 – Midsized – Sled Base

COM 1.5 yd
0.75 yd COM per single seat
0.75 yd COM per single back

| MODEL | COM | GR 1 | GR 2 | GR 3 | GR 4 | GR 5 | GR 6 |
|-------------|------------|------------|------------|------------|------------|------------|------------|
| 1844 | 417 | 517 | 549 | 616 | 716 | 794 | 893 |

Dimensions (inches)

| | seat H | 18.0 | seat W | 22.0 | arm H | N/A |
|---------|--------|---------|--------|-------|-------|-----|
| total H | 33.0 | total W | 24.0 | depth | 22.0 | |

Exceeds BIFMA Seating Durability Test to 500 lbs
CAL 133, add \$87 List
1" extra seat foam, specify and add \$23 List



1844
Without arms
22 lbs

Snowball 1 – Bariatric – Sled Base

COM 2.0 yd
1.0 yd COM per single seat
1.0 yd COM per single back

| MODEL | COM | GR 1 | GR 2 | GR 3 | GR 4 | GR 5 | GR 6 |
|-------------|------------|------------|------------|------------|------------|------------|-------------|
| 1843 | 569 | 670 | 704 | 770 | 870 | 945 | 1046 |

Dimensions (inches)

| | seat H | 18.0 | seat W | 26.0 | arm H | N/A |
|---------|--------|---------|--------|-------|-------|-----|
| total H | 33.0 | total W | 28.0 | depth | 22.0 | |

Exceeds BIFMA Seating Durability Test to 500 lbs
CAL 133, add \$87 List
1" extra seat foam, specify and add \$32 List



1843
Without arms
27 lbs



SNOWBALL 1 Public Seating

Casters

Standard Features

- 0.875" frame
- Seat and back upholstered
- Polyurethane arms available in Black (B), Sterling Grey (G) or Taupe RAL 7006 (T)
- Frame in any Spectone color
- Black non-locking casters
- Four-point stacks 10 high with dolly, 6 without dolly
- Ships 1/carton 11 cu ft, 2-3/carton 22 cu ft

Options

- Antibacterial and antimicrobial fabrics available
- Different fabric on seat and back at no upcharge
- Armless and sled base versions not available
- CAL 133
- DuraSpec seat is available on 18"w and 22"w chairs only - call Customer Service for pricing.

Contact Spec Customer Service to railroad fabrics (specify repeat info and yardage requirement will be provided) and for repeats greater than 5" x 5"



Optional DuraSpec seat



Snowball 1 – Casters

COM 1.0 yd
 0.5 yd COM per single seat
 0.5 yd COM per single back

| MODEL | COM | GR 1 | GR 2 | GR 3 | GR 4 | GR 5 | GR 6 |
|-------|-----|------|------|------|------|------|------|
| 1802 | 460 | 510 | 527 | 562 | 610 | 649 | 702 |

Dimensions (inches)

| | seat H | 18.0 | seat W | 18.5 | arm H | 26.0 |
|---------|--------|---------|--------|-------|-------|------|
| total H | 33.0 | total W | 23.5 | depth | 21.5 | |

Exceeds BIFMA Seating Durability Test to 500 lbs
 CAL 133, add \$62 List
 1" extra seat foam, specify and add \$15 List



1802
 With arms
 19 lbs



SNOWBALL 1 Public Seating

Stools

Standard Features

- 0.875" frame
- Seat and back upholstered
- Polyurethane arms available in Black (B), Sterling Grey (G) or Taupe RAL 7006 (T)
- Frame in any Spectone color
- Does not stack
- Ships 1/carton 17 cu ft

Options

- Antibacterial and antimicrobial fabrics available
- Different fabric on seat and back at no upcharge
- Casters, sled base not available
- CAL 133
- Other glides may be available for an upcharge - call Customer Service to inquire
- DuraSpec seat is available on 18"w and 22"w chairs only - call Customer Service for pricing.

Contact Spec Customer Service to railroad fabrics (specify repeat info and yardage requirement will be provided) and for repeats greater than 5" x 5"



Optional DuraSpec seat

Snowball 1 – Stools

COM 1.0 yd
0.5 yd COM per single seat
0.5 yd COM per single back

| MODEL | COM | GR 1 | GR 2 | GR 3 | GR 4 | GR 5 | GR 6 |
|-------------|------------|------------|------------|------------|------------|------------|------------|
| 1821 | 447 | 498 | 513 | 548 | 598 | 635 | 686 |
| 1825 | 447 | 498 | 513 | 548 | 598 | 635 | 686 |

Dimensions (inches)

| | seat H | 28.0 | seat W | 18.0 | arm H | 36.0 | total H | 43.5 |
|-------|--------|---------|--------|-------------------|-------|------|---------|------|
| depth | 21.5 | total W | 23.5 | total W (no arms) | 20.1 | | | |

Exceeds BIFMA Seating Durability Test to 500 lbs
CAL 133, add \$62 List
1" extra seat foam, specify and add \$15 List



1821
With arms
23 lbs



1825
Without arms
22 lbs

Snowball 1 – Midsize Stools

COM 1.5 yd
0.75 yd COM per single seat
0.75 yd COM per single back

| MODEL | COM | GR 1 | GR 2 | GR 3 | GR 4 | GR 5 | GR 6 |
|-------------|------------|------------|------------|------------|------------|------------|-------------|
| 1824 | 532 | 633 | 668 | 733 | 833 | 909 | 1010 |
| 1826 | 532 | 633 | 668 | 733 | 833 | 909 | 1010 |

Dimensions (inches)

| | seat H | 28.0 | seat W | 22.0 | arm H | 36.0 | total H | 43.5 |
|-------|--------|---------|--------|-------------------|-------|------|---------|------|
| depth | 22.0 | total W | 26.9 | total W (no arms) | 24.0 | | | |

Exceeds BIFMA Seating Durability Test to 500 lbs
CAL 133, add \$87 List
1" extra seat foam, specify and add \$23 List



1824
With arms
25 lbs



1826
Without arms
24 lbs



SNOWBALL 1 Public Seating

Easy Access Hip Single Seater

Standard Features

- 0.875" frame
- Seat and back upholstered
- Polyurethane arms available in Black (B), Sterling Grey (G) or Taupe RAL 7006 (T)
- Frame in any Spectone color
- Does not stack
- Ships 1/carton 19 cu ft

Options

- Antibacterial and antimicrobial fabrics available
- Different fabric on seat and back at no upcharge
- Casters, sled base not available
- CAL 133
- Other glides may be available for an upcharge - call Customer Service to inquire
- DuraSpec seat is available on 18"w and 22"w chairs only - call Customer Service for pricing.

Contact Spec Customer Service to railroad fabrics (specify repeat info and yardage requirement will be provided) and for repeats greater than 5" x 5"



Optional DuraSpec seat

Snowball 1 – Easy Access Hip Single Seater

COM 1.0 yd
0.5 yd COM per single seat
0.5 yd COM per single back

| MODEL | COM | GR 1 | GR 2 | GR 3 | GR 4 | GR 5 | GR 6 |
|--------------|------------|------------|------------|------------|------------|------------|------------|
| 1821E | 492 | 543 | 558 | 594 | 643 | 679 | 730 |

Dimensions (inches)

| | seat H | 24.0 | seat W | 18.0 | arm H | 32.0 |
|---------|--------|---------|--------|-------|-------|------|
| total H | 38.5 | total W | 23.5 | depth | 31.0 | |

Exceeds BIFMA Seating Durability Test to 500 lbs
CAL 133, add \$62 List
1" extra seat foam, specify and add \$15 List



1821E
With arms
32 lbs

Snowball 1 – Midsize Easy Access Hip Single Seater

COM 1.5 yd
0.75 yd COM per single seat
0.75 yd COM per single back

| MODEL | COM | GR 1 | GR 2 | GR 3 | GR 4 | GR 5 | GR 6 |
|--------------|------------|------------|------------|------------|------------|------------|-------------|
| 1824E | 582 | 683 | 718 | 783 | 884 | 960 | 1061 |

Dimensions (inches)

| | seat H | 24.0 | seat W | 22.0 | arm H | 32.0 |
|---------|--------|---------|--------|-------|-------|------|
| total H | 38.5 | total W | 26.9 | depth | 31.0 | |

Exceeds BIFMA Seating Durability Test to 500 lbs
CAL 133, add \$87 List
1" extra seat foam, specify and add \$23 List



1824E
With arms
34 lbs



SNOWBALL 1 Public Seating

Dolly

Standard Features

- Black finish only
- 2" black swivel casters
- Standard Dolly stacks 10 chairs
- Midsize Dolly stacks 4 chairs
- Bariatric Dolly stacks 4 chairs
- Ships 1/carton 17 cu ft

Options

- Please specify if Dolly is for chairs with wall-saving frame



Standard and Midsize available on Spec 10 Day Program



Snowball 1 – Dolly

| DESCRIPTION | MODEL | PRICE |
|----------------------|--------------|------------|
| Standard | 1899 | 367 |
| 22" Midsize | 1899M | 526 |
| 26" Bariatric | 1899G | 526 |

Dimensions (inches)

| Standard | | Midsize / Bariatric | |
|----------|------|---------------------|------|
| height | 36.5 | height | 36.5 |
| width | 21.0 | width | 23.0 |
| depth | 31.0 | depth | 42.0 |



1899
Standard
18 lbs



1899G/1899M
Midsize/Bariatric
24 lbs



SNOWBALL 1 Public Seating

Connected and Tables

To order connected Snowballs

- Select and price the Snowballs required for your configuration
- Select and price the corner, spacer and end tables required
- Add Snowball connecting bars (between chairs only). Do not add connecting bars for tables (they are part of the table)
- Send a drawing with your order or call Spec for assistance

Snowball Tables

- Table top is 3/4" thick
- Self Edge, PVC Flat and 2mm edge available. PVC Flat edge and 2 mm Bio edge available in 38 solid colors. 2mm PVC edge available in wood grain to match 9 standard stains.
- Select laminate tops from 15 standard laminates or choose any standard Wilsonart, Nevamar, Formica, Arborite and Pionite matte finish laminates at no upcharge.

Connecting bars and tables can be retrofitted, allowing you to change configurations later or create new configurations from your present Snowballs

Connecting bars can be added to any Snowball chair, including Bariatric and Midsize

Connecting bars and table frame bars are finished in the same color as the color of the chair frames

Connecting bars are fastened to the underside of the Snowball chair frame at the front and back



Snowball 1 – Connected and Tables



| DESCRIPTION | Corner Table | Spacer Table | Mini Spacer Table | End Table* | Connecting Bars |
|---------------------|--------------|--------------|-------------------|------------|-----------------|
| MODEL | 18RC | 18ST | 18MT | 18ET | 18CON |
| DIMENSIONS (inches) | 25 x 25 | 17 x 17 | 4.5 x 14.5 | 17 x 17 | N/A |
| PRICE | 354 | 242 | 145 | 252 | 85 |

*End table is handed, provide layout

SNOWBALL 1 Public Seating

Tablet Arms and Wire Basket

Tablet Arm

- Fits any Snowball, freestanding or within a configuration
- Standard or laptop size available
- Right and left handed versions (defined when sitting in chair), add TR for right handed or TL for left handed to model number
- Laminated on both sides, standard in Wilsonart Dove Grey D-92-60 with flat black PVC edge. For other laminate please contact the factory for pricing
- Tablet constructed of 3/4" NU Green earth friendly core
- Snowball with Tablet Arm is standard with no arm on opposite side
- Add price of Tablet Arm to your Snowball selection

Wire Basket

- Add to any 18" wide Snowball
- Black
- Removable



Note: We do not recommend stacking Snowballs that have tablet arms



Snowball 1 – Tablet Arms and Wire Basket



DESCRIPTION
MODEL
PRICE

Standard Tablet Arm
TR (right) or TL (left)
248

Laptop Tablet Arm
LTR (right) or LTL (left)
279

Wire Basket
WB
Call For Pricing

Dimensions (inches)

height 27.5
width 12.75
total W 24.5
length 24.0
tablet extends 6" from seat

height 27.5
width 16.0
total W 24.5
length 24.75
tablet extends 7" from seat



SNOWBALL 2 Public Seating



PRODUCT CODE

18 51

Series

18 : Snowball 2

Chair Type

- | | | | |
|-------------------------|--------------------------|-----------------------|------------------------|
| 51 : Four Point/Arms | 54 : 22"/4-point/Arms | 93 : 26"/Sled/No Arms | 74 : 22"/Stool/Arms |
| 61 : Four Point/No Arms | 64 : 22"/4-Point/No Arms | 52 : Casters/Arms | 76 : 22"/Stool/No Arms |
| 81 : Sled Base/Arms | 53 : 26"/4-Point/Arms | 71 : Stool/Arms | 71E : Hip Chair |
| 91 : Sled BaseNo Arms | 94 : 22"/Sled/No Arms | 75 : Stool/No Arms | 74E : 22" Hip Chair |



OPTIONS

WALL-SAVING



DURASPEC SEAT



FINISHES

FRAME



Select from one of our 76 standard Spectone colors

FABRIC



Select fabrics from one of our textile partners

ARMS

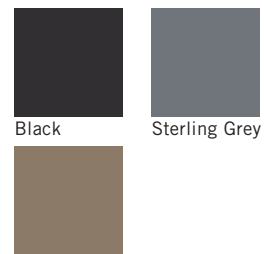

Taupe

See Spectone Card or specfurniture.com/materials/finishes for a complete list of finish options and colors.



SNOWBALL 2 Public Seating

BACK TO CONTENTS

HOW TO ORDER

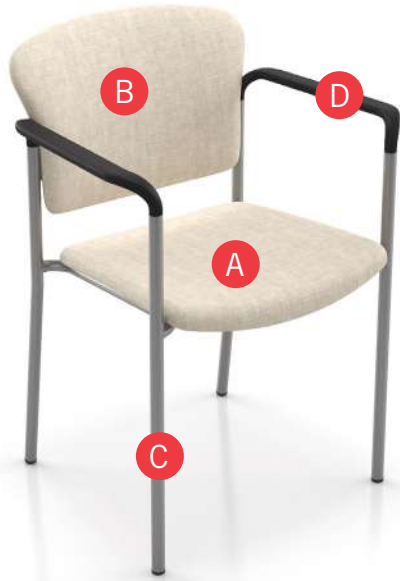

Specify Model

- A** Specify Fabric - Seat
Manufacturer, Pattern Name, Color
- B** Specify Fabric - Back
Manufacturer, Pattern Name, Color
- C** Specify Frame Finish
- D** Specify Polyurethane Arm Color

Optional: CAL 133, Moisture Barrier, Wall-saving Frame, Connecting Bars, Tablet Arm, Wire Basket, DuraSpec Seat, Connecting Tables, Dolly

Restrictions may apply. See price list tables below for more information.



| Model | Fabric - Seat | Fabric - Back | Frame Finish | Polyurethane Arm Color |
|-------|---------------------------|---------------------------|--------------|------------------------|
| 1851 | Momentum, Beeline, Canvas | Momentum, Beeline, Canvas | Silver | Black |

SNOWBALL 2 Public Seating

Four-point and Sled Base

Standard Features

- 0.875" frame
- Seat and back upholstered
- Back has enhanced contours for superior comfort
- Polyurethane arms available in Black (B), Sterling Grey (G) or Taupe RAL 7006 (T)
- Frame in any Spectone color
- Four-point stacks 10 high with dolly, 6 without dolly
- Sled Base does not stack and ships 1 per carton
- Ships 1/carton 11 cu ft, 2-4/carton 22 cu ft

Contact Spec Customer Service to railroad fabrics (specify repeat info and yardage requirement will be provided) and for repeats greater than 5" x 5"



Available on Spec 10 Day Program

Options

- Wall-saving frame on Four-point only, add \$22 List
- Connecting bars for a structured reconfigurable layout, add \$85 List
- Antibacterial and antimicrobial fabrics available
- Different fabric on seat and back at no upcharge
- Tablet Arm available on Snowballs without arms
- CAL 133
- Other glides may be available for an upcharge - call Customer Service to inquire
- DuraSpec seat is available on 18"w and 22"w chairs only - call Customer Service for pricing



Optional wall-saving frame



Optional DuraSpec seat

Snowball 2 – Four-point

COM 1.0 yd
0.5 yd COM per single seat
0.5 yd COM per single back

| MODEL | COM | GR 1 | GR 2 | GR 3 | GR 4 | GR 5 | GR 6 |
|-------|-----|------|------|------|------|------|------|
| 1851 | 354 | 412 | 430 | 466 | 523 | 565 | 620 |
| 1861 | 354 | 412 | 430 | 466 | 523 | 565 | 620 |

Dimensions (inches)
seat H 18.0 seat W 18.0 arm H 26.0 total H 33.0
depth 21.5 total W 23.5 total W (no arms) 20.1

Exceeds BIFMA Seating Durability Test to 500 lbs
CAL 133, add \$62 List
1" extra seat foam, specify and add \$15 List



1851
With arms
20 lbs



1861
Without arms
19 lbs

Snowball 2 – Sled Base

COM 1.0 yd
0.5 yd COM per single seat
0.5 yd COM per single back

| MODEL | COM | GR 1 | GR 2 | GR 3 | GR 4 | GR 5 | GR 6 |
|-------|-----|------|------|------|------|------|------|
| 1881 | 370 | 425 | 443 | 480 | 537 | 578 | 634 |
| 1891 | 370 | 425 | 443 | 480 | 537 | 578 | 634 |

Dimensions (inches)
seat H 18.0 seat W 18.0 arm H 26.0 total H 33.0
depth 21.5 total W 23.5 total W (no arms) 20.1

Exceeds BIFMA Seating Durability Test to 500 lbs
CAL 133, add \$62 List
1" extra seat foam, specify and add \$15 List



1881
With arms
23 lbs



1891
Without arms
22 lbs



SNOWBALL 2 Public Seating

Midsize and Bariatric – Four-point

Standard Features

- 0.875" frame
- Seat and back upholstered
- Back has enhanced contours for superior comfort
- Polyurethane arms available in Black (B), Sterling Grey (G) or Taupe RAL 7006 (T)
- Frame in any Spectone color
- Four-point stacks 4 high on floor or with dolly
- Ships 1-3/carton 21.24 cu ft for Midsize and 1-3/ carton 24.17 cu ft for Bariatric

Options

- Wall-saving frame, add \$22 List
- Connecting bars for a structured reconfigurable layout, add \$85 List
- Antibacterial and antimicrobial fabrics available
- Different fabric on seat and back at no upcharge
- CAL 133
- Other glides may be available for an upcharge - call Customer Service to inquire
- DuraSpec seat is available on 18"w and 22"w chairs only - call Customer Service for pricing

Contact Spec Customer Service to railroad fabrics (specify repeat info and yardage requirement will be provided) and for repeats greater than 5" x 5"



Available on Spec 10 Day Program



Optional wall-saving frame



Optional DuraSpec seat

Snowball 2 – Midsize – Four-point

COM 1.5 yd
0.75 yd COM per single seat
0.75 yd COM per single back

| MODEL | COM | GR 1 | GR 2 | GR 3 | GR 4 | GR 5 | GR 6 |
|-------|-----|------|------|------|------|------|------|
| 1854 | 414 | 517 | 550 | 618 | 723 | 802 | 905 |
| 1864 | 414 | 517 | 550 | 618 | 723 | 802 | 905 |

*1864 Not Available on 10 Day Program

Dimensions (inches)

| | seat H | 18.0 | seat W | 22.0 | arm H | 26.0 | total H | 33.0 |
|-------|--------|---------|--------|-------------------|-------|------|---------|------|
| depth | 22.0 | total W | 26.9 | total W (no arms) | 24.0 | | | |

Exceeds BIFMA Seating Durability Test to 500 lbs
CAL 133, add \$87 List
1" extra seat foam, specify and add \$23 List



1854
With arms
22 lbs

1864
Without arms
21 lbs

*Not Available on 10 Day Program

Snowball 2 – Bariatric – Four-point

COM 2.0 yd
1.0 yd COM per single seat
1.0 yd COM per single back

| MODEL | COM | GR 1 | GR 2 | GR 3 | GR 4 | GR 5 | GR 6 |
|-------|-----|------|------|------|------|------|------|
| 1853 | 567 | 670 | 706 | 773 | 878 | 954 | 1059 |

Dimensions (inches)

| | seat H | 18.0 | seat W | 26.0 | arm H | 26.0 |
|---------|--------|---------|--------|-------|-------|------|
| total H | 33.0 | total W | 31.0 | depth | 22.0 | |

Exceeds BIFMA Seating Durability Test to 500 lbs
CAL 133, add \$87 List
1" extra seat foam, specify and add \$32 List



1853
With arms
26 lbs



SNOWBALL 2 Public Seating

Midsized and Bariatric – Sled Base

Standard Features

- 0.875" frame
- Seat and back upholstered
- Back has enhanced contours for superior comfort
- Frame in any Spectone color
- Does not stack
- Ships 1/carton 21 cu ft

Contact Spec Customer Service to railroad fabrics (specify repeat info and yardage requirement will be provided) and for repeats greater than 5" x 5"

Options

- Connecting bars for a structured reconfigurable layout, add \$85 List
- Antibacterial and antimicrobial fabrics available
- Different fabric on seat and back at no upcharge
- Tablet Arm available on Snowballs without arms
- CAL 133
- Other glides may be available for an upcharge - call Customer Service to inquire
- DuraSpec seat is available on 18"w and 22"w chairs only - call Customer Service for pricing



Optional DuraSpec seat

Snowball 2 – Midsized – Sled Base

COM 1.5 yd
0.75 yd COM per single seat
0.75 yd COM per single back

| MODEL | COM | GR 1 | GR 2 | GR 3 | GR 4 | GR 5 | GR 6 |
|-------------|------------|------------|------------|------------|------------|------------|------------|
| 1894 | 449 | 551 | 587 | 653 | 757 | 836 | 940 |

Dimensions (inches)

| | seat H | 18.0 | seat W | 22.0 | arm H | N/A |
|---------|--------|---------|--------|-------|-------|-----|
| total H | 33.0 | total W | 24.0 | depth | 22.0 | |

Exceeds BIFMA Seating Durability Test to 500 lbs
CAL 133, add \$87 List
1" extra seat foam, specify and add \$23 List



1894
Without arms
22 lbs

Snowball 2 – Bariatric – Sled Base

COM 2.0 yd
1.0 yd COM per single seat
1.0 yd COM per single back

| MODEL | COM | GR 1 | GR 2 | GR 3 | GR 4 | GR 5 | GR 6 |
|-------------|------------|------------|------------|------------|------------|------------|-------------|
| 1893 | 603 | 706 | 742 | 809 | 912 | 990 | 1095 |

Dimensions (inches)

| | seat H | 18.0 | seat W | 26.0 | arm H | N/A |
|---------|--------|---------|--------|-------|-------|-----|
| total H | 33.0 | total W | 28.0 | depth | 22.0 | |

Exceeds BIFMA Seating Durability Test to 500 lbs
CAL 133, add \$87 List
1" extra seat foam, specify and add \$32 List



1893
Without arms
27 lbs



SNOWBALL 2 Public Seating

Casters

Standard Features

- 0.875" frame
- Seat and back upholstered
- Back has enhanced contours for superior comfort
- Polyurethane arms available in Black (B), Sterling Grey (G) or Taupe RAL 7006 (T)
- Frame in any Spectone color
- Black non-locking casters
- Four-point stacks 10 high with dolly, 6 without dolly
- Ships 1/carton 11 cu ft, 2-3/carton 22 cu ft

Options

- Antibacterial and antimicrobial fabrics available
- Different fabric on seat and back at no upcharge
- Armless and sled base versions not available
- CAL 133
- DuraSpec seat is available on 18"w and 22"w chairs only - call Customer Service for pricing

Contact Spec Customer Service to railroad fabrics (specify repeat info and yardage requirement will be provided) and for repeats greater than 5" x 5"



Optional DuraSpec seat



Snowball 2 – Casters

COM 1.0 yd
 0.5 yd COM per single seat
 0.5 yd COM per single back

| MODEL | COM | GR 1 | GR 2 | GR 3 | GR 4 | GR 5 | GR 6 |
|-------------|------------|------------|------------|------------|------------|------------|------------|
| 1852 | 483 | 538 | 556 | 594 | 649 | 691 | 748 |

Dimensions (inches)

| | | | | | |
|---------|------|---------|------|-------|------|
| seat H | 18.0 | seat W | 18.0 | arm H | 26.0 |
| total H | 33.0 | total W | 23.5 | depth | 21.5 |

Exceeds BIFMA Seating Durability Test to 500 lbs
 CAL 133, add \$62 List
 1" extra seat foam, specify and add \$15 List



1852
With arms
 19 lbs

SNOWBALL 2 Public Seating

Stools

Standard Features

- 0.875" frame
- Seat and back upholstered
- Back has enhanced contours for superior comfort
- Polyurethane arms available in Black (B), Sterling Grey (G) or Taupe RAL 7006 (T)
- Frame in any Spectone color
- Does not stack
- Ships 1/carton 17 cu ft

Options

- Antibacterial and antimicrobial fabrics available
- Different fabric on seat and back at no upcharge
- Casters, sled base not available
- CAL 133
- Other glides may be available for an upcharge - call Customer Service to inquire
- DuraSpec seat is available on 18"w and 22"w chairs only - call Customer Service for pricing

Contact Spec Customer Service to railroad fabrics (specify repeat info and yardage requirement will be provided) and for repeats greater than 5" x 5"



Optional DuraSpec seat

Snowball 2 – Stools

COM 1.0 yd
0.5 yd COM per single seat
0.5 yd COM per single back

| MODEL | COM | GR 1 | GR 2 | GR 3 | GR 4 | GR 5 | GR 6 |
|-------|-----|------|------|------|------|------|------|
| 1871 | 471 | 527 | 546 | 582 | 639 | 681 | 735 |
| 1875 | 471 | 527 | 546 | 582 | 639 | 681 | 735 |

Dimensions (inches)

| | seat H | 28.0 | seat W | 18.0 | arm H | 36.0 | total H | 43.5 |
|-------|--------|---------|--------|-------------------|-------|------|---------|------|
| depth | 21.5 | total W | 23.5 | total W (no arms) | 20.1 | | | |

Exceeds BIFMA Seating Durability Test to 500 lbs
CAL 133, add \$62 List
1" extra seat foam, specify and add \$15 List



1871
With arms
23 lbs



1875
Without arms
22 lbs

Snowball 2 – Midsize Stools

COM 1.5 yd
0.75 yd COM per single seat
0.75 yd COM per single back

| MODEL | COM | GR 1 | GR 2 | GR 3 | GR 4 | GR 5 | GR 6 |
|-------|-----|------|------|------|------|------|------|
| 1874 | 566 | 670 | 703 | 770 | 874 | 955 | 1058 |
| 1876 | 566 | 670 | 703 | 770 | 874 | 955 | 1058 |

Dimensions (inches)

| | seat H | 28.0 | seat W | 22.0 | arm H | 36.0 | total H | 43.5 |
|-------|--------|---------|--------|-------------------|-------|------|---------|------|
| depth | 22.0 | total W | 26.9 | total W (no arms) | 24.0 | | | |

Exceeds BIFMA Seating Durability Test to 500 lbs
CAL 133, add \$87 List
1" extra seat foam, specify and add \$23 List



1874
With arms
25 lbs



1876
Without arms
24 lbs



SNOWBALL 2 Public Seating

Easy Access Hip Single Seater

Standard Features

- 0.875" frame
- Seat and back upholstered
- Back has enhanced contours for superior comfort
- Polyurethane arms available in Black (B), Sterling Grey (G) or Taupe RAL 7006 (T)
- Frame in any Spectone color
- Does not stack
- Ships 1/carton 19 cu ft

Options

- Antibacterial and antimicrobial fabrics available
- Different fabric on seat and back at no upcharge
- Casters, sled base not available
- CAL 133
- Other glides may be available for an upcharge - call Customer Service to inquire
- DuraSpec seat is available on 18"w and 22"w chairs only - call Customer Service for pricing

Contact Spec Customer Service to railroad fabrics (specify repeat info and yardage requirement will be provided) and for repeats greater than 5" x 5"



Optional DuraSpec seat



Snowball 2 – Easy Access Hip Single Seater

COM 1.0 yd
0.5 yd COM per single seat
0.5 yd COM per single back

| MODEL | COM | GR 1 | GR 2 | GR 3 | GR 4 | GR 5 | GR 6 |
|--------------|------------|------------|------------|------------|------------|------------|------------|
| 1871E | 515 | 571 | 592 | 627 | 683 | 726 | 780 |

Dimensions (inches)
seat H 24.0 seat W 18.0 arm H 32.0
total H 38.5 total W 23.5 depth 31.0

Exceeds BIFMA Seating Durability Test to 500 lbs
CAL 133, add \$62 List
1" extra seat foam, specify and add \$15 List



1871E
With arms
32 lbs

Snowball 2 – Midsize Easy Access Hip Single Seater

COM 1.5 yd
0.75 yd COM per single seat
0.75 yd COM per single back

| MODEL | COM | GR 1 | GR 2 | GR 3 | GR 4 | GR 5 | GR 6 |
|--------------|------------|------------|------------|------------|------------|-------------|-------------|
| 1874E | 616 | 720 | 753 | 820 | 925 | 1005 | 1108 |

Dimensions (inches)
seat H 24.0 seat W 22.0 arm H 32.0
total H 38.5 total W 26.9 depth 31.0

Exceeds BIFMA Seating Durability Test to 500 lbs
CAL 133, add \$87 List
1" extra seat foam, specify and add \$23 List



1874E
With arms
34 lbs



SNOWBALL 2 Public Seating

Dolly

Standard Features

- Black finish only
- 2" black swivel casters
- Standard Dolly stacks 10 chairs
- Midsize Dolly stacks 4 chairs
- Bariatric Dolly stacks 4 chairs
- Ships 1/carton 17 cu ft

Options

- Please specify if Dolly is for chairs with wall-saving frame



Standard and Midsize available on Spec 10 Day Program



Snowball 2 – Dolly

| DESCRIPTION | MODEL | PRICE |
|----------------------|--------------|------------|
| Standard | 1899 | 367 |
| 22" Midsize | 1899M | 526 |
| 26" Bariatric | 1899G | 526 |

Dimensions (inches)

| Standard | | Midsize / Bariatric | |
|----------|------|---------------------|------|
| height | 36.5 | height | 36.5 |
| width | 21.0 | width | 23.0 |
| depth | 31.0 | depth | 42.0 |



1899
Standard
18 lbs



1899G/1899M
Midsize/Bariatric
24 lbs

SNOWBALL 2 Public Seating

Connected and Tables

To order connected Snowballs

- Select and price the Snowballs required for your configuration
- Select and price the corner, spacer and end tables required
- Add Snowball connecting bars (between chairs only). Do not add connecting bars for tables (they are part of the table)
- Send a drawing with your order or call Spec for assistance

Snowball Tables

- Table top is 3/4" thick
- Self Edge, PVC Flat and 2mm edge available. PVC Flat edge and 2 mm Bio edge available in 38 solid colors. 2mm PVC edge available in wood grain to match 9 standard stains.
- Select laminate tops from 15 standard laminates or choose any standard Wilsonart, Nevamar, Formica, Arborite and Pionite matte finish laminates at no upcharge.

Connecting bars and tables can be retrofitted, allowing you to change configurations later or create new configurations from your present Snowballs

Connecting bars can be added to any Snowball chair, including Bariatric and Midsize

Connecting bars and table frame bars are finished in the same color as the color of the chair frames

Connecting bars are fastened to the underside of the Snowball chair frame at the front and back



Snowball 2 – Connected and Tables



| DESCRIPTION | Corner Table | Spacer Table | Mini Spacer Table | End Table* | Connecting Bars |
|---------------------|--------------|--------------|-------------------|------------|-----------------|
| MODEL | 18RC | 18ST | 18MT | 18ET | 18CON |
| DIMENSIONS (inches) | 25 x 25 | 17 x 17 | 4.5 x 14.5 | 17 x 17 | N/A |
| PRICE | 354 | 242 | 145 | 252 | 85 |

*End table is handed, provide layout



SNOWBALL 2 Public Seating

Tablet Arms and Wire Basket

Tablet Arm

- Fits any Snowball, freestanding or within a configuration
- Standard or laptop size available
- Right and left handed versions (defined when sitting in chair), add TR for right handed or TL for left handed to model number
- Laminated on both sides, standard in Wilsonart Dove Grey D-92-60 with flat black PVC edge. For other laminate please contact the factory for pricing
- Tablet constructed of 3/4" NU Green earth friendly core
- Snowball with Tablet Arm is standard with no arm on opposite side
- Add price of Tablet Arm to your Snowball selection

Wire Basket

- Add to any 18" wide Snowball
- Black
- Removable



Note: We do not recommend stacking Snowballs that have tablet arms



Snowball 2 – Tablet Arms and Wire Basket

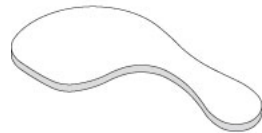

DESCRIPTION
MODEL
PRICE

Standard Tablet Arm
TR (right) or TL (left)
248

Laptop Tablet Arm
LTR (right) or LTL (left)
279

Wire Basket
WB
Call For Pricing

Dimensions (inches)

height 27.5
width 12.75
total W 24.5
length 24.0
tablet extends 6" from seat

height 27.5
width 16.0
total W 24.5
length 24.75
tablet extends 7" from seat

SNOWBALL 3 Public Seating



PRODUCT CODE

19 01

Series

19 : Snowball 3

Chair Type

- | | | | |
|-------------------------|--------------------------|-----------------------|------------------------|
| 01 : Four Point/Arms | 04 : 22"/4-point/Arms | 43 : 26"/Sled/No Arms | 24 : 22"/Stool/Arms |
| 11 : Four Point/No Arms | 14 : 22"/4-Point/No Arms | 02 : Casters/Arms | 26 : 22"/Stool/No Arms |
| 31 : Sled Base/Arms | 03 : 26"/4-Point/Arms | 21 : Stool/Arms | 21E : Hip Chair |
| 41 : Sled Base/No Arms | 44 : 22"/Sled/No Arms | 51 : Stool/No Arms | 24E : 22" Hip Chair |



OPTIONS

WALL-SAVING



DURASPEC SEAT



WOOD BACK OPTIONS

| | | | | |
|-------------------|----------------|---------------|--|----------|
| | | | | |
| Cutout A | Cutout B | Cutout C | Cutout D | Cutout E |
| | | | *Custom engravings, cutouts and decals are available. Please call for pricing. | |
| Custom Engraving* | Custom Cutout* | Custom Decal* | | |

FINISHES

FRAME



Select from one of our 76 standard Spectone colors

FABRIC



Select fabrics from one of our textile partners

ARMS

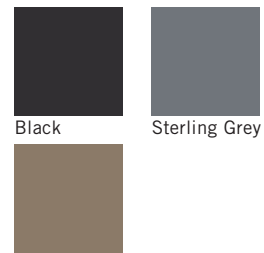

Taupe

See Spectone Card or specfurniture.com/materials/finishes for a complete list of finish options and colors.



SNOWBALL 3 Public Seating

HOW TO ORDER

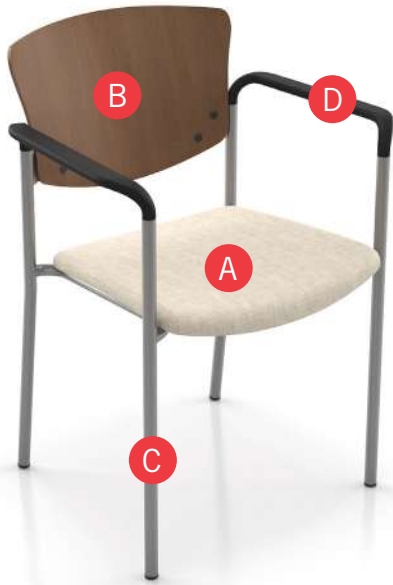

Specify Model

- A** Specify Fabric - Seat
Manufacturer, Pattern Name, Color
- B** Specify Wood Stain - Back
Specify Back Design
- C** Specify Frame Finish
- D** Specify Polyurethane Arm Color

Optional: Wood Seat, Custom Back Design, CAL 133, Moisture Barrier, Wall-saving Frame, Connecting Bars, Tablet Arm, Wire Basket, DuraSpec Seat, Connecting Tables, Dolly

Restrictions may apply. See price list tables below for more information.



| Model | Fabric - Seat | Wood Stain - Back, Back Design | Frame Finish | Polyurethane Arm Color |
|-------|---------------------------|-----------------------------------|--------------|------------------------|
| 1901 | Momentum, Beeline, Canvas | Studio Teak Stain, No Back Design | Silver | Black |

SNOWBALL 3 Public Seating

Four-point and Sled Base

Standard Features

- 0.875" frame
- Upholstered seat and wood back
- Seat and/or back in Natural Maple in any of 9 standard stains or stain-to-match at no upcharge
- Choice of 5 back cut-outs
- Polyurethane arms available in Black (B), Sterling Grey (G) or Taupe RAL 7006 (T)
- Frame in any Spectone color
- Four-point stacks 10 high with dolly, 6 without dolly
- Sled Base does not stack and ships 1 per carton
- Ships 1/carton 11 cu ft, 2-4/carton 22 cu ft

Contact Spec Customer Service to railroad fabrics (specify repeat info and yardage requirement will be provided) and for repeats greater than 5" x 5"



Available on Spec 10 Day Program

Options

- Wood seat, add \$59 List to COM price
- Custom back cut-outs and engravings
- Wall-saving frame on Four-point only, add \$22 List
- Connecting bars for a structured reconfigurable layout, add \$85 List
- Antibacterial and antimicrobial fabrics available
- Different fabric on seat and back at no upcharge
- Tablet Arm available on Snowballs without arms
- CAL 133
- Other glides may be available for an upcharge - call Customer Service to inquire
- DuraSpec seat is available on 18"w and 22"w chairs only - call Customer Service for pricing



Optional wall-saving frame



Optional DuraSpec seat

Snowball 3 – Four-point

COM 0.5 yd
0.5 yd COM per single seat

| MODEL | COM | GR 1 | GR 2 | GR 3 | GR 4 | GR 5 | GR 6 |
|-------|-----|------|------|------|------|------|------|
| 1901 | 431 | 458 | 467 | 487 | 513 | 536 | 563 |
| 1911 | 431 | 458 | 467 | 487 | 513 | 536 | 563 |

Dimensions (inches)

| | seat H | 18.0 | seat W | 18.0 | arm H | 26.0 | total H | 33.0 |
|-------|--------|---------|--------|-------------------|-------|------|---------|------|
| depth | 21.5 | total W | 23.5 | total W (no arms) | 20.1 | | | |

Exceeds BIFMA Seating Durability Test to 500 lbs
CAL 133, add \$32 List
1" extra seat foam, specify and add \$15 List



1901
With arms
18 lbs



1911
Without arms
17 lbs

Snowball 3 – Sled Base

COM 0.5 yd
0.5 yd COM per single seat

| MODEL | COM | GR 1 | GR 2 | GR 3 | GR 4 | GR 5 | GR 6 |
|-------|-----|------|------|------|------|------|------|
| 1931 | 444 | 472 | 483 | 500 | 528 | 549 | 577 |
| 1941 | 444 | 472 | 483 | 500 | 528 | 549 | 577 |

Dimensions (inches)

| | seat H | 18.0 | seat W | 18.0 | arm H | 26.0 | total H | 33.0 |
|-------|--------|---------|--------|-------------------|-------|------|---------|------|
| depth | 21.5 | total W | 23.5 | total W (no arms) | 20.1 | | | |

Exceeds BIFMA Seating Durability Test to 500 lbs
CAL 133, add \$32 List
1" extra seat foam, specify and add \$15 List



1931
With arms
21 lbs



1941
Without arms
20 lbs

SNOWBALL 3 Public Seating

Midsized and Bariatric – Four-point

Standard Features

- 0.875" frame
- Upholstered seat and wood back
- Seat and/or back in Natural Maple in any of 9 standard stains or stain-to-match at no upcharge
- Choice of 5 back cut-outs
- Polyurethane arms available in Black (B), Sterling Grey (G) or Taupe RAL 7006 (T)
- Frame in any Spectone color
- Four-point stacks 4 high on floor or with dolly
- Ships 1-3/carton 21.24 cu ft for Midsized and 1-3/ carton 24.17 cu ft for Bariatric

Options

- Custom back cut-outs and engravings
- Wall-saving frame, add \$22 List
- Connecting bars for a structured reconfigurable layout, add \$85 List
- Antibacterial and antimicrobial fabrics available
- Different fabric on seat and back at no upcharge
- CAL 133
- Other glides may be available for an upcharge - call Customer Service to inquire
- DuraSpec seat is available on 18"w and 22"w chairs only - call Customer Service for pricing

Contact Spec Customer Service to railroad fabrics (specify repeat info and yardage requirement will be provided) and for repeats greater than 5" x 5"



Available on Spec 10 Day Program



Optional wall-saving frame



Optional DuraSpec seat

Snowball 3 – Midsized – Four-point

COM 0.75 yd
0.75 yd COM per single seat

| MODEL | COM | GR 1 | GR 2 | GR 3 | GR 4 | GR 5 | GR 6 |
|-------|-----|------|------|------|------|------|------|
| 1904 | 464 | 509 | 524 | 551 | 597 | 632 | 676 |
| 1914 | 464 | 509 | 524 | 551 | 597 | 632 | 676 |

*1914 Not Available on 10 Day Program

Dimensions (inches)

| | | | | | | | |
|--------|------|---------|------|-------------------|------|---------|------|
| seat H | 18.0 | seat W | 22.0 | arm H | 26.0 | total H | 33.0 |
| depth | 22.0 | total W | 26.9 | total W (no arms) | 24.0 | | |

Exceeds BIFMA Seating Durability Test to 500 lbs
CAL 133, add \$44 List
1" extra seat foam, specify and add \$23 List



1904
With arms
20 lbs

1914
Without arms
19 lbs

*Not Available on 10 Day Program

Snowball 3 – Bariatric – Four-point

COM 1.0 yd
1.0 yd COM per single seat

| MODEL | COM | GR 1 | GR 2 | GR 3 | GR 4 | GR 5 | GR 6 |
|-------|-----|------|------|------|------|------|------|
| 1903 | 582 | 627 | 644 | 671 | 716 | 750 | 795 |

Dimensions (inches)

| | | | | | |
|---------|------|---------|------|-------|------|
| seat H | 18.0 | seat W | 26.0 | arm H | 26.0 |
| total H | 33.0 | total W | 31.0 | depth | 22.0 |

Exceeds BIFMA Seating Durability Test to 500 lbs
CAL 133, add \$44 List
1" extra seat foam, specify and add \$32 List



1903
With arms
25 lbs

SNOWBALL 3 Public Seating

Midsized and Bariatric – Sled Base

Standard Features

- 0.875" frame
- Upholstered seat and wood back
- Seat and/or back in Natural Maple in any of 9 standard stains or stain-to-match at no upcharge
- Choice of 5 back cut-outs
- Seat and back upholstered
- Frame in any Spectone color
- Does not stack
- Ships 1/carton 21 cu ft

Contact Spec Customer Service to railroad fabrics (specify repeat info and yardage requirement will be provided) and for repeats greater than 5" x 5"

Options

- Custom back cut-outs and engravings
- Connecting bars for a structured reconfigurable layout, add \$85 List
- Antibacterial and antimicrobial fabrics available
- Different fabric on seat and back at no upcharge
- Tablet Arm available on Snowballs without arms
- CAL 133
- Other glides may be available for an upcharge - call Customer Service to inquire
- DuraSpec seat is available on 18"w and 22"w chairs only - call Customer Service for pricing



Optional DuraSpec seat

Snowball 3 – Midsized – Sled Base

COM 0.75 yd
0.75 yd COM per single seat

| MODEL | COM | GR 1 | GR 2 | GR 3 | GR 4 | GR 5 | GR 6 |
|-------------|------------|------------|------------|------------|------------|------------|------------|
| 1944 | 499 | 543 | 560 | 588 | 633 | 668 | 712 |

Dimensions (inches)

| | | | | | |
|---------|------|---------|------|-------|------|
| seat H | 18.0 | seat W | 22.0 | arm H | N/A |
| total H | 33.0 | total W | 24.0 | depth | 22.0 |

Exceeds BIFMA Seating Durability Test to 500 lbs
CAL 133, add \$44 List
1" extra seat foam, specify and add \$23 List



1944
Without arms
21 lbs

Snowball 3 – Bariatric – Sled Base

COM 1.0 yd
1.0 yd COM per single seat

| MODEL | COM | GR 1 | GR 2 | GR 3 | GR 4 | GR 5 | GR 6 |
|-------------|------------|------------|------------|------------|------------|------------|------------|
| 1943 | 617 | 664 | 677 | 707 | 751 | 785 | 830 |

Dimensions (inches)

| | | | | | |
|---------|------|---------|------|-------|------|
| seat H | 18.0 | seat W | 26.0 | arm H | N/A |
| total H | 33.0 | total W | 28.0 | depth | 22.0 |

Exceeds BIFMA Seating Durability Test to 500 lbs
CAL 133, add \$44 List
1" extra seat foam, specify and add \$32 List



1943
Without arms
26 lbs



SNOWBALL 3 Public Seating

Casters

Standard Features

- 0.875" frame
- Upholstered seat and wood back
- Seat and/or back in Natural Maple in any of 9 standard stains or stain-to-match at no upcharge
- Choice of 5 back cut-outs
- Seat and back upholstered
- Polyurethane arms available in Black (B), Sterling Grey (G) or Taupe RAL 7006 (T)
- Frame in any Spectone color
- Black non-locking casters
- Four-point stacks 10 high with dolly, 6 without dolly
- Ships 1/carton 11 cu ft, 2-3/carton 22 cu ft

Options

- Wood seat, add \$59 List to COM price
- Custom back cut-outs and engravings
- Antibacterial and antimicrobial fabrics available
- Different fabric on seat and back at no upcharge
- Armless and sled base versions not available
- CAL 133
- DuraSpec seat is available on 18"w and 22"w chairs only - call Customer Service for pricing

Contact Spec Customer Service to railroad fabrics (specify repeat info and yardage requirement will be provided) and for repeats greater than 5" x 5"



Optional DuraSpec seat



Snowball 3 – Casters

COM 0.5 yd
0.5 yd COM per single seat

| MODEL | COM | GR 1 | GR 2 | GR 3 | GR 4 | GR 5 | GR 6 |
|-------|-----|------|------|------|------|------|------|
| 1902 | 558 | 588 | 597 | 614 | 644 | 665 | 691 |

| Dimensions (inches) | | | | | | | |
|---------------------|------|---------|------|-------|------|-----------|--------|
| seat H | 18.0 | seat W | 18.0 | arm H | 26.0 | armless W | 20.125 |
| total H | 33.0 | total W | 23.5 | depth | 21.5 | | |

Exceeds BIFMA Seating Durability Test to 500 lbs
CAL 133, add \$32 List
1" extra seat foam, specify and add \$15 List



1902
With arms
19 lbs



SNOWBALL 3 Public Seating

Stools

Standard Features

- 0.875" frame
 - Upholstered seat and wood back
 - Seat and/or back in Natural Maple in any of 9 standard stains or stain-to-match at no upcharge
 - Choice of 5 back cut-outs
 - Seat and back upholstered
 - Polyurethane arms available in Black (B), Sterling Grey (G) or Taupe RAL 7006 (T)
 - Frame in any Spectone color
 - Does not stack
- Ships 1/carton 17 cu ft

Options

- Wood seat, add \$59 List to COM price
- Custom back cut-outs and engravings
- Antibacterial and antimicrobial fabrics available
- Different fabric on seat and back at no upcharge
- Casters, sled base not available
- CAL 133
- Other glides may be available for an upcharge - call Customer Service to inquire
- DuraSpec seat is available on 18"w and 22"w chairs only - call Customer Service for pricing

Contact Spec Customer Service to railroad fabrics (specify repeat info and yardage requirement will be provided) and for repeats greater than 5" x 5"



Optional DuraSpec seat

Snowball 3 – Stool

COM 0.5 yd
0.5 yd COM per single seat

| MODEL | COM | GR 1 | GR 2 | GR 3 | GR 4 | GR 5 | GR 6 |
|-------|-----|------|------|------|------|------|------|
| 1921 | 545 | 571 | 581 | 600 | 627 | 649 | 676 |
| 1951 | 545 | 571 | 581 | 600 | 627 | 649 | 676 |

Dimensions (inches)

| seat H | 28.0 | seat W | 18.0 | arm H | 36.0 | total H | 43.5 |
|--------|------|---------|------|-------------------|------|---------|------|
| depth | 21.5 | total W | 23.5 | total W (no arms) | 20.1 | | |

Exceeds BIFMA Seating Durability Test to 500 lbs
CAL 133, add \$32 List
1" extra seat foam, specify and add \$15 List



1921
With arms
21 lbs



1951
Without arms
20 lbs

Snowball 3 – Midsize Stools

COM 0.75 yd
0.75 yd COM per single seat

| MODEL | COM | GR 1 | GR 2 | GR 3 | GR 4 | GR 5 | GR 6 |
|-------|-----|------|------|------|------|------|------|
| 1924 | 616 | 659 | 676 | 704 | 749 | 784 | 828 |
| 1926 | 616 | 659 | 676 | 704 | 749 | 784 | 828 |

Dimensions (inches)

| seat H | 28.0 | seat W | 22.0 | arm H | 36.0 | total H | 43.5 |
|--------|------|---------|------|-------------------|------|---------|------|
| depth | 22.0 | total W | 26.9 | total W (no arms) | 24.0 | | |

Exceeds BIFMA Seating Durability Test to 500 lbs
CAL 133, add \$44 List
1" extra seat foam, specify and add \$23 List



1924
With arms
25 lbs



1926
Without arms
24 lbs

SNOWBALL 3 Public Seating

Easy Access Hip Single Seater

Standard Features

- 0.875" frame
- Seat and back upholstered
- Polyurethane arms available in Black (B), Sterling Grey (G) or Taupe RAL 7006 (T)
- Frame in any Spectone color
- Does not stack
- Ships 1/carton 19 cu ft

Contact Spec Customer Service to railroad fabrics (specify repeat info and yardage requirement will be provided) and for repeats greater than 5" x 5"

Options

- Wood seat, add \$59 List to COM price
- Antibacterial and antimicrobial fabrics available
- Different fabric on seat and back at no upcharge
- Casters, sled base not available
- CAL 133
- Other glides may be available for an upcharge - call Customer Service to inquire
- DuraSpec seat is available on 18"w and 22"w chairs only - call Customer Service for pricing



Optional DuraSpec seat



Snowball 3 – Easy Access Hip Chair

COM 0.5 yd
0.5 yd COM per single seat

| MODEL | COM | GR 1 | GR 2 | GR 3 | GR 4 | GR 5 | GR 6 |
|--------------|------------|------------|------------|------------|------------|------------|------------|
| 1921E | 591 | 616 | 626 | 645 | 672 | 693 | 721 |

Dimensions (inches)

| | | | | | |
|---------|------|---------|------|-------|------|
| seat H | 24.0 | seat W | 18.0 | arm H | 32.0 |
| total H | 38.5 | total W | 23.5 | depth | 31.0 |

Exceeds BIFMA Seating Durability Test to 500 lbs
CAL 133, add \$32 List
1" extra seat foam, specify and add \$15 List



1921E
With arms
30 lbs

Snowball 3 – Midsize Easy Access Hip Single Seater

COM 0.75 yd
0.75 yd COM per single seat

| MODEL | COM | GR 1 | GR 2 | GR 3 | GR 4 | GR 5 | GR 6 |
|--------------|------------|------------|------------|------------|------------|------------|------------|
| 1924E | 667 | 710 | 726 | 754 | 799 | 834 | 878 |

Dimensions (inches)

| | | | | | |
|---------|------|---------|------|-------|------|
| seat H | 24.0 | seat W | 22.0 | arm H | 32.0 |
| total H | 38.5 | total W | 26.9 | depth | 31.0 |

Exceeds BIFMA Seating Durability Test to 500 lbs
CAL 133, add \$44 List
1" extra seat foam, specify and add \$23 List



1924E
With arms
32 lbs

SNOWBALL 3 Public Seating

Dolly

Standard Features

- Black finish only
- 2" black swivel casters
- Standard Dolly stacks 10 chairs
- Midsize Dolly stacks 4 chairs
- Bariatric Dolly stacks 4 chairs
- Ships 1/carton 17 cu ft

Options

- Please specify if Dolly is for chairs with wall-saving frame



Standard and Midsize available on Spec 10 Day Program



Snowball 3 – Dolly

| DESCRIPTION | MODEL | PRICE |
|----------------------|--------------|------------|
| Standard | 1899 | 367 |
| 22" Midsize | 1899M | 526 |
| 26" Bariatric | 1899G | 526 |

Dimensions (inches)

| Standard | | Midsize / Bariatric | |
|----------|------|---------------------|------|
| height | 36.5 | height | 36.5 |
| width | 21.0 | width | 23.0 |
| depth | 31.0 | depth | 42.0 |



1899
Standard
18 lbs



1899G/1899M
Midsize/Bariatric
24 lbs

SNOWBALL 3 Public Seating

Connected and Tables

To order connected Snowballs

- Select and price the Snowballs required for your configuration
- Select and price the corner, spacer and end tables required
- Add Snowball connecting bars (between chairs only). Do not add connecting bars for tables (they are part of the table)
- Send a drawing with your order or call Spec for assistance

Snowball Tables

- Table top is 3/4" thick
- Self Edge, PVC Flat and 2mm edge available. PVC Flat edge and 2 mm Bio edge available in 38 solid colors. 2mm PVC edge available in wood grain to match 9 standard stains.
- Select laminate tops from 15 standard laminates or choose any standard Wilsonart, Nevamar, Formica, Arborite and Pionite matte finish laminates at no upcharge.

Connecting bars and tables can be retrofitted, allowing you to change configurations later or create new configurations from your present Snowballs

Connecting bars can be added to any Snowball chair, including Bariatric and Midsize

Connecting bars and table frame bars are finished in the same color as the color of the chair frames

Connecting bars are fastened to the underside of the Snowball chair frame at the front and back



Snowball 3 – Connected and Tables



| DESCRIPTION | Corner Table | Spacer Table | Mini Spacer Table | End Table* | Connecting Bars |
|---------------------|--------------|--------------|-------------------|------------|-----------------|
| MODEL | 18RC | 18ST | 18MT | 18ET | 18CON |
| DIMENSIONS (inches) | 25 x 25 | 17 x 17 | 4.5 x 14.5 | 17 x 17 | N/A |
| PRICE | 354 | 242 | 145 | 252 | 85 |

*End table is handed, provide layout

SNOWBALL 3 Public Seating

Tablet Arms and Wire Basket

Tablet Arm

- Fits any Snowball, freestanding or within a configuration
- Standard or laptop size available
- Right and left handed versions (defined when sitting in chair), add TR for right handed or TL for left handed to model number
- Laminated on both sides, standard in Wilsonart Dove Grey D-92-60 with flat black PVC edge. For other laminate please contact the factory for pricing
- Tablet constructed of 3/4" NU Green earth friendly core
- Snowball with Tablet Arm is standard with no arm on opposite side
- Add price of Tablet Arm to your Snowball selection

Wire Basket

- Add to any 18" wide Snowball
- Black
- Removable



Note: We do not recommend stacking Snowballs that have tablet arms



Snowball 3 – Tablet Arms and Wire Basket



DESCRIPTION
MODEL
PRICE

Standard Tablet Arm
TR (right) or TL (left)
248

Laptop Tablet Arm
LTR (right) or LTL (left)
279

Wire Basket
WB
Call For Pricing

Dimensions (inches)

height 27.5
width 12.75
total W 24.5
length 24.0
tablet extends 6" from seat

height 27.5
width 16.0
total W 24.5
length 24.75
tablet extends 7" from seat

SNOWBALL 3 Public Seating

Wood Back Options

Wood Back

- Backs standard in Natural maple in any of 9 standard stains or stain-to-match at no upcharge
- On the 10 Day Program; only back design A is available in Cherry stain or Natural Maple stain

Custom Wood Back Cut-out

- A one time set up charge of \$279 list applies
- Design should fit within a 5" x 5" space (due to contour of back)
- Shape will be mirrored from the front of the chair

Pick a back design and add suffix A-E following the model number, e.g. 1901BA (Snowball 3 with black arms and back design A)

Custom Wood Back Engraving and Vinyl Decals

- For quantities over 25, add an upcharge of \$57 List/chair
- For quantities under 25, add an upcharge of \$57 List/chair, plus a \$279 List set up fee **per order**

Engravings: Please note that inconsistencies in the wood may show after the engraving is completed. When choosing the raw wood, we take extra care to select backs that are similar in graining and color, however, no guarantee can be made. We recommend that an engraved image be stained a darker color to hide possible inconsistencies.

Snowball 3 – Wood Back Designs



Wood Back Design "A"



Wood Back Design "B"



Wood Back Design "C"



Wood Back Design "D"



Wood Back Design "E"

Snowball 3 – Custom Wood Back Cut-out



Snowball 3 – Custom Wood Back Engraving



Snowball 3 – Custom Wood Back Vinyl Decals



Available up to 4"x4"
Maximum of 4 colors per decal
Vector based files required

SNOWFLAKE Children's Series



PRODUCT CODE

CHAIR

1805

Series

- 1805 : Snowflake 1
- 1855 : Snowflake 2
- 1905 : Snowflake 3

TABLE

24 SF

Size

- 24 : 24"
- 30 : 30"
- 36 : 36"

Collection

SF : Snowflake

OPTIONS

SNOWFLAKE 3 BACK

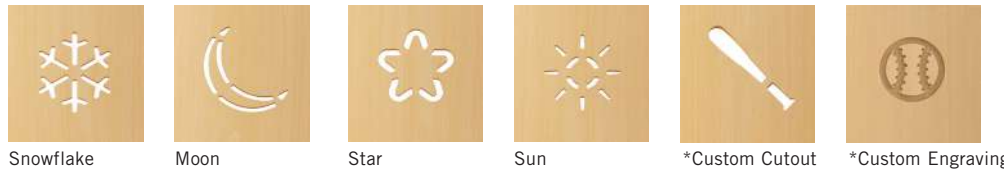

**Custom engravings and cutouts are available. Please call for pricing.*

FINISHES

FRAME



Select from one of our 76 standard Spectone colors

FABRIC

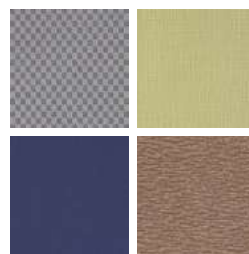

Select fabrics from one of our textile partners

BACK STAIN

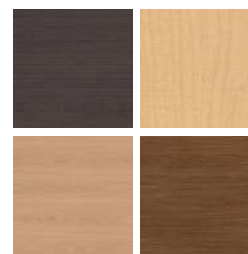

Select from one of our 9 standard wood stains or stain-to-match at no upcharge

See Spectone Card or specfurniture.com/materials/finishes for a complete list of finish options and colors.



SNOWFLAKE Children's Series

BACK TO CONTENTS

HOW TO ORDER

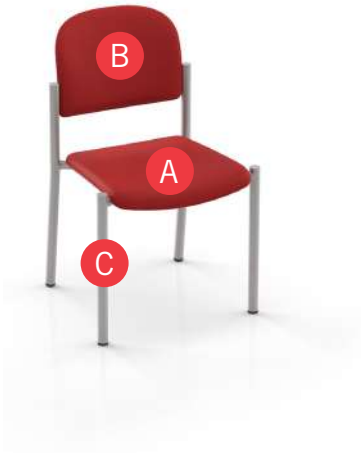

Specify Model

- A** Specify Fabric - Seat
Manufacturer, Pattern Name, Color
- B** Specify Back
For Snowflake 1 and Snowflake 2: Fabric Manufacturer, Pattern Name, Color
For Snowflake 3: Wood Stain - Back, and Standard Back Design
- C** Specify Frame Finish

Optional: Custom Back Design, Wood Seat, CAL 133, Moisture Barrier, Freestanding Tables

Restrictions may apply. See price list tables below for more information.

| Model | Fabric - Seat | Back | Frame Finish |
|-------|--------------------------------|--------------------------------|--------------|
| 1805 | CF Stinson, Wyatt WYA19, Blaze | CF Stinson, Wyatt WYA19, Blaze | Silver |





SNOWFLAKE Children's Series

Snowflake 1 and 2

Standard Features

- Snowflake 1; seat and back upholstered
- Snowflake 2; seat and back upholstered, back has enhanced contours for superior comfort
- Frame in any Spectone color
- Stack 4 high
- Ships 2/carton 6 cu ft

Options

- Antibacterial and antimicrobial fabrics available
- Different fabric on seat and back at no upcharge
- CAL 133

Contact Spec Customer Service to railroad fabrics (specify repeat info and yardage requirement will be provided) and for repeats greater than 5" x 5"



Snowflake 1

COM 0.83 yds
0.33 yd COM per single seat / 0.5 yd COM per single back

| MODEL | COM | GR 1 | GR 2 | GR 3 | GR 4 | GR 5 | GR 6 |
|-------------|------------|------------|------------|------------|------------|------------|------------|
| 1805 | 324 | 359 | 371 | 395 | 431 | 457 | 502 |

Dimensions (inches)

| | seat H | 14.0 | seat W | 13.0 | arm H | N/A |
|---------|--------|---------|--------|-------|-------|-----|
| total H | 24.0 | total W | 15.25 | depth | 15.0 | |

CAL 133, add \$63 List per seat



1805
10 lbs

Snowflake 2

COM 0.83 yds
0.33 yd COM per single seat / 0.5 yd COM per single back

| MODEL | COM | GR 1 | GR 2 | GR 3 | GR 4 | GR 5 | GR 6 |
|-------------|------------|------------|------------|------------|------------|------------|------------|
| 1855 | 338 | 375 | 386 | 407 | 444 | 470 | 515 |

Dimensions (inches)

| | seat H | 14.0 | seat W | 13.0 | arm H | N/A |
|---------|--------|---------|--------|-------|-------|-----|
| total H | 24.0 | total W | 15.25 | depth | 15.0 | |

CAL 133, add \$63 List per seat



1855
10 lbs



SNOWFLAKE Children's Series

Snowflake 3

Standard Features

- Seat upholstered with wood back
- Natural maple back in any of 9 standard stains or stain-to-match at no upcharge
- Frame in any Spectone color
- Stack 4 high
- Ships 2/carton 6 cu ft

Contact Spec Customer Service to railroad fabrics (specify repeat info and yardage requirement will be provided) and for repeats greater than 5" x 5"

Options

- Snowflake, Star, Sun and Moon cut-outs at no upcharge
- Custom cut-outs and engravings
- Wood seat, add \$59 List to COM price
- Antibacterial and antimicrobial fabrics available
- Different fabric on seat and back at no upcharge
- CAL 133

Custom Seat Back Cut-out

- A one time set up charge of \$279 List applies
- Design should fit within a 5" x 5" space (due to contour of back)
- Shape will be mirrored from the front of the chair

Custom Seat Back Engraving

- For quantities over 25, add an upcharge of \$57 List/chair
- For quantities under 25 add an upcharge of \$57 List/chair, plus a \$279 List set up **fee per order**

Please note that inconsistencies in the wood may show after the engraving is completed. When choosing the raw wood, we take extra care to select backs that are similar in graining and color, however, no guarantee can be made. We recommend that an engraved image be stained a darker color to hide possible inconsistencies.



Snowflake 3

COM 0.33 yds
0.33 yd COM per single seat

| MODEL | COM | GR 1 | GR 2 | GR 3 | GR 4 | GR 5 | GR 6 |
|-------|-----|------|------|------|------|------|------|
| 1905 | 353 | 370 | 378 | 387 | 404 | 419 | 444 |

Dimensions (inches)

| | | | | | |
|---------|------|---------|-------|-------|------|
| seat H | 14.0 | seat W | 13.0 | arm H | N/A |
| total H | 24.0 | total W | 15.25 | depth | 15.0 |

CAL 133, add \$34 List per seat



1905
10 lbs

Snowflake – Seat Back Designs



Snowflake



Star



Sun



Moon



SNOWFLAKE Children's Series

Freestanding Table

Standard Features

- Tops constructed from 0.75" particle board core with laminate surface and backer
- Select from 15 standard laminates or choose any standard Wilsonart, Nevamar, Formica, Arborite and Pionite matte finish laminates at no upcharge. For other laminate please contact the factory for pricing.
- Edge is PVC Flat (PVF) with 38 colors available to match base finishes
- Frame in any Spectone color
- Tops utilize NU Green earth friendly core
- 22" height
- Ships 1/carton

Options

- Non-standard laminates, contact Spec for pricing
- Other shapes such as round or square are available in non-stacking designs
- Other sizes may be available



Freestanding Table

| Top Size (inches, OD) | Snowflake (SF) | Round (SFR) | Square (SFSQ) | Weight | Cu.Ft. |
|-----------------------|----------------|-------------|---------------|--------|--------|
| 24 | 616 | 616 | 616 | 27 | 11 |
| 30 | 726 | 726 | 726 | 37 | 16 |
| 36 | 796 | 796 | 796 | 48 | 22 |



TAILOR Lounge Collection - FREESTANDING



PRODUCT CODE

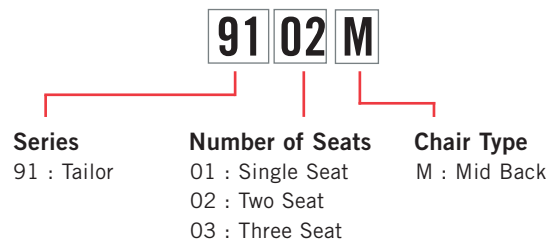

OPTIONS

ARM GAP



ARM CAP



POWER



In table



In seat

FINISHES

FRAME



Select from one of our 76 standard Spectone colors

FABRIC



Select fabrics from one of our textile partners

LAMINATE

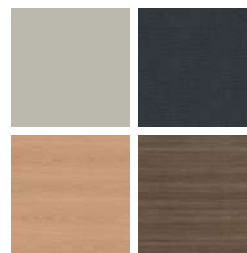

Select from 15 standard laminates or choose any standard Wilsonart, Nevamar, Formica, Arborite and Pionite matte finish laminates at no upcharge

EDGE



SE

ARM CAPS



Polyurethane

Wood

See Spectone Card or specfurniture.com/materials/finishes for a complete list of finish options and colors.



TAILOR Lounge Collection - FREESTANDING

HOW TO ORDER

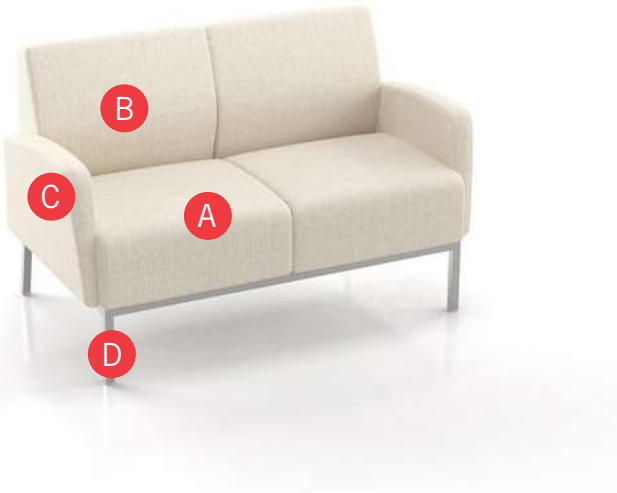

Specify Model

- A** Specify Fabric - Seat¹
Manufacturer, Pattern Name, Color
- B** Specify Fabric - Back¹
Manufacturer, Pattern Name, Color
- C** Specify Fabric - Arms¹
Manufacturer, Pattern Name, Color
- D** Specify Frame Finish

Optional: CAL 133, Moisture Barrier, 1" Gap Between Seat and Arm, Arm Caps, Connecting and Freestanding Tables, Power

Restrictions may apply. See price list tables below for more information.

¹ When multiple fabrics are specified on two and three seat chairs, please provide a drawing and legend for fabric placement.



| Model | Fabric - Seat 1 | Fabric - Seat 2 | Fabric - Back 1 | Fabric - Back 2 | Fabric - Arm 1 | Fabric - Arm 2 | Frame Finish |
|-------|---------------------------|---------------------------|---------------------------|---------------------------|---------------------------|---------------------------|--------------|
| 9102M | Momentum, Beeline, Canvas | Momentum, Beeline, Canvas | Momentum, Beeline, Canvas | Momentum, Beeline, Canvas | Momentum, Beeline, Canvas | Momentum, Beeline, Canvas | Silver |

TAILOR Lounge Collection - FREESTANDING

Standard Features

- Separate seat and back
- Wall-saving frame
- Glides
- Ships assembled
- Ships 1/carton 24 cu ft

Contact Spec Customer Service to railroad fabrics (specify repeat info and yardage requirement will be provided) and for repeats greater than 5" x 5"



Wall-saving Frame

Options

- Polyurethane arm caps available in Black (B), Taupe RAL 7006 (T) or Sterling Grey (G), add \$118 List per arm
- For wood arm caps, select from 9 standard stains, or stain-to-match at no upcharge, add \$139 List per arm
- 1" gap between seat and arm available at \$48 List per arm
- Upholstered arms/seat/back can match or contrast
- Cove Mini power module centered in the seat front is available in Black, Silver Pearl and Gloss White. Add \$426 List per seat per module
- Antibacterial and antimicrobial fabrics available
- Freestanding tables available
- CAL 133



Tapered End Arm



Cove Mini

Single Seat Without Arms

COM 2.75 yds
 1.25 yds COM per single seat
 1.5 yds COM per single back

| MODEL | COM | GR 1 | GR 2 | GR 3 | GR 4 | GR 5 | GR 6 |
|-----------------|------------|-------------|-------------|-------------|-------------|-------------|-------------|
| 9101M-NA | 919 | 1066 | 1114 | 1216 | 1366 | 1481 | 1634 |

Dimensions (inches)
 seat H 18.0 seat W 23.0
 total H 33.0 total W 23.0 total D 29.0

Exceeds BIFMA Seating Durability Test to 500 lbs
 CAL 133, add \$209 List per unit



9101M-NA
43 lbs

Single Seat With Arms

COM 4.25 yds
 1.25 yds COM per single seat
 1.5 yds COM per single back
 0.75 yds COM per arm

| MODEL | COM | GR 1 | GR 2 | GR 3 | GR 4 | GR 5 | GR 6 |
|--------------|-------------|-------------|-------------|-------------|-------------|-------------|-------------|
| 9101M | 1265 | 1494 | 1569 | 1727 | 1962 | 2142 | 2381 |

Dimensions (inches)
 seat H 18.0 seat W 23.0 arm H 24.5
 total H 33.0 total W 29.5 total D 29.0

Exceeds BIFMA Seating Durability Test to 500 lbs
 CAL 133, add \$323 List per unit



9101M
67 lbs



TAILOR Lounge Collection - FREESTANDING

Standard Features

- Separate seat and back
- Wall-saving frame
- Glides
- Ships assembled
- Ships 1/carton 32 cu ft

Contact Spec Customer Service to railroad fabrics (specify repeat info and yardage requirement will be provided) and for repeats greater than 5" x 5"



Wall-saving Frame

Options

- Polyurethane arm caps available in Black (B), Taupe RAL 7006 (T) or Sterling Grey (G), add \$118 List per arm
- For wood arm caps, select from 9 standard stains, or stain-to-match at no upcharge, add \$139 List per arm
- 1" gap between seat and arm available at \$48 List per arm
- Upholstered arms/seat/back can match or contrast
- Cove Mini power module centered in the seat front is available in Black, Silver Pearl and Gloss White. Add \$426 List per seat per module
- Antibacterial and antimicrobial fabrics available
- Freestanding tables available
- CAL 133



Tapered End Arm



Cove Mini

Bariatric Single Seat With Arms

COM 5 yds
 1.5 yds COM per single seat
 2 yds COM per single back
 0.75 yds COM per arm

| MODEL | COM | GR 1 | GR 2 | GR 3 | GR 4 | GR 5 | GR 6 |
|--------------|-------------|-------------|-------------|-------------|-------------|-------------|-------------|
| 9101G | 1397 | 1671 | 1761 | 1950 | 2229 | 2443 | 2727 |

Dimensions (inches)

| | | | | | |
|---------|------|---------|------|-------|------|
| seat H | 18.0 | seat W | 30.0 | arm H | 24.5 |
| total H | 33.0 | total W | 36.5 | depth | 29.0 |

Exceeds BIFMA Seating Durability Test to 750 lbs
 CAL 133, add \$381 List per unit



9101G
75 lbs



TAILOR Lounge Collection - FREESTANDING

Standard Features

- Separate seat and back
- Wall-saving frame
- Glides
- Ships assembled
- Ships 1/carton 43 cu ft

Contact Spec Customer Service to railroad fabrics (specify repeat info and yardage requirement will be provided) and for repeats greater than 5" x 5"



Wall-saving Frame

Options

- Polyurethane arm caps available in Black (B), Taupe RAL 7006 (T) or Sterling Grey (G), add \$118 List per arm
- For wood arm caps, select from 9 standard stains, or stain-to-match at no upcharge, add \$139 List per arm
- 1" gap between seat and arm available at \$48 List per arm
- Upholstered arms/seat/back can match or contrast
- Cove Mini power module centered in the seat front is available in Black, Silver Pearl and Gloss White. Add \$426 List per seat per module
- Antibacterial and antimicrobial fabrics available
- Freestanding tables available
- CAL 133



Tapered End Arm



Cove Mini

Two Seat Without Arms

COM 5.5 yds
 1.25 yds COM per single seat
 1.5 yds COM per single back

| MODEL | COM | GR 1 | GR 2 | GR 3 | GR 4 | GR 5 | GR 6 |
|-----------------|-------------|-------------|-------------|-------------|-------------|-------------|-------------|
| 9102M-NA | 1629 | 1923 | 2020 | 2222 | 2523 | 2753 | 3059 |

Dimensions (inches)
 seat H 18.0 seat W 23.0
 total H 33.0 total W 46.0 total D 29.0

Exceeds BIFMA Seating Durability Test to 570 lbs
 CAL 133, add \$418 List per unit



9102M-NA
92 lbs

Two Seat With Arms

COM 7 yds
 1.25 yds COM per single seat
 1.5 yds COM per single back
 0.75 yds COM per arm

| MODEL | COM | GR 1 | GR 2 | GR 3 | GR 4 | GR 5 | GR 6 |
|--------------|-------------|-------------|-------------|-------------|-------------|-------------|-------------|
| 9102M | 1974 | 2351 | 2474 | 2735 | 3119 | 3414 | 3805 |

Dimensions (inches)
 seat H 18.0 seat W 23.0 arm H 24.5
 total H 33.0 total W 52.5 total D 29.0

Exceeds BIFMA Seating Durability Test to 570 lbs
 CAL 133, add \$532 List per unit



9102M
116 lbs



TAILOR Lounge Collection - FREESTANDING

Standard Features

- Separate seat and back
- Wall-saving frame
- Glides
- Ships assembled
- Ships 1/carton 62 cu ft

Contact Spec Customer Service to railroad fabrics (specify repeat info and yardage requirement will be provided) and for repeats greater than 5" x 5"



Wall-saving Frame

Options

- Polyurethane arm caps available in Black (B), Taupe RAL 7006 (T) or Sterling Grey (G), add \$118 List per arm
- For wood arm caps, select from 9 standard stains, or stain-to-match at no upcharge, add \$139 List per arm
- 1" gap between seat and arm available at \$48 List per arm
- Upholstered arms/seat/back can match or contrast
- Cove Mini power module centered in the seat front is available in Black, Silver Pearl and Gloss White. Add \$426 List per seat per module
- Antibacterial and antimicrobial fabrics available
- Freestanding tables available
- CAL 133



Tapered End Arm



Cove Mini

Three Seat Without Arms

COM 8.25 yds
 1.25 yds COM per single seat
 1.5 yds COM per single back

| MODEL | COM | GR 1 | GR 2 | GR 3 | GR 4 | GR 5 | GR 6 |
|-----------------|-------------|-------------|-------------|-------------|-------------|-------------|-------------|
| 9103M-NA | 2338 | 2780 | 2924 | 3229 | 3680 | 4026 | 4483 |

Dimensions (inches)
 seat H 18.0 seat W 23.0
 total H 33.0 total W 69.0 depth 29.0

Exceeds BIFMA Seating Durability Test to 750 lbs
 CAL 133, add \$627 List per unit



9103M-NA
137 lbs

Three Seat With Arms

COM 9.75 yds
 1.25 yds COM per single seat
 1.5 yds COM per single back
 0.75 yds COM per arm

| MODEL | COM | GR 1 | GR 2 | GR 3 | GR 4 | GR 5 | GR 6 |
|--------------|-------------|-------------|-------------|-------------|-------------|-------------|-------------|
| 9103M | 2684 | 3208 | 3380 | 3742 | 4276 | 4686 | 5229 |

Dimensions (inches)
 seat H 18.0 seat W 23.0 arm H 24.5
 total H 33.0 total W 75.5 depth 29.0

Exceeds BIFMA Seating Durability Test to 750 lbs
 CAL 133, add \$741 List per unit



9103M
161 lbs



TAILOR Lounge Collection - FREESTANDING TABLES

Standard Features

- Tables in laminate or veneer
- Select laminate tops from 15 standard laminates or choose any standard Wilsonart, Nevamar, Formica, Arborite and Pionite matte finish laminates at no upcharge.
- 9 standard veneers. Stain-to-match available at no upcharge.
- Tables available with Self Edge (SE) only
- Steel table legs available in any Spectone color
- Tops utilize NU Green earth friendly core
- Glides
- Ships assembled
- 18" height

Options

- To add Cove Mini, clamp mounted with 1 power, 2 USB (charging only), and a 108" long cord to Tailor freestanding tables, add \$344 List. Cove will be located on the flat front face of the closed tables as standard. It is not recommended to specify power on open tables. Specify separately at time of order.



- Black **COVSMC1P1U-B**
- Silver Pearl **COVSMC1P1U-S**
- Gloss White **COVSMC1P1U-W**



Freestanding Lounge Tables

| Model | Laminate SE | Veneer SE | Weight | Cu.Ft. |
|---|-------------|-----------|--------|--------|
| 91ETC - 24 x 24 SQ <i>End Table Closed - 24 x 24</i> | 969 | 1357 | 39 | 11 |
| 91ETO - 24 x 24 SQ <i>End Table Open - 24 x 24</i> | 991 | 1387 | 38 | 11 |
| 91REC - 24 x 48 RE <i>Coffee Table Closed - 24 x 48</i> | 1109 | 1552 | 67 | 20 |
| 91REOS - 24 x 48 RE <i>Coffee Table Open, One Side - 24 x 48</i> | 1328 | 1860 | 67 | 20 |
| 91REOB - 24 x 48 RE <i>Coffee Table Open, Both Sides - 24 x 48</i> | 1360 | 1904 | 71 | 20 |



91ETC
39 lbs



91ETO
38 lbs



91REC
67 lbs



91REOS
67 lbs



91REOB
71 lbs

TAILOR Lounge Collection - BENCH



PRODUCT CODE

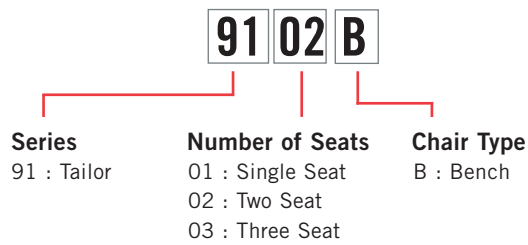

FINISHES

FRAME



Select from one of our 76 standard Spectone colors

FABRIC



Select fabrics from one of our textile partners

POWER



In seat

See Spectone Card or specfurniture.com/materials/finishes for a complete list of finish options and colors.

HOW TO ORDER

Specify Model

- A** Specify Fabric - Seat¹
Manufacturer, Pattern Name, Color
- B** Specify Frame Finish

Optional: CAL 133, Moisture Barrier, Connecting and Freestanding Tables, Power

¹ When multiple fabrics are specified on two and three seat chairs, please provide a drawing and legend for fabric placement.



| Model | Fabric - Seat 1 | Fabric - Seat 2 | Fabric - Seat 3 | Frame Finish |
|-------|---------------------------|---------------------------|---------------------------|--------------|
| 9103B | Momentum, Beeline, Canvas | Momentum, Beeline, Canvas | Momentum, Beeline, Canvas | Silver |

TAILOR Lounge Collection - BENCH

Standard Features

- One piece seat upholstery for easier maintenance
- Non wall-saving frame
- Glides
- Ships assembled
- Ships 1 single seat bench per carton, 11 cu ft
- Ships 1 two seat bench per carton, 20 cu ft

Contact Spec Customer Service to railroad fabrics (specify repeat info and yardage requirement will be provided) and for repeats greater than 5" x 5".



Non Wall-saving Frame

Options

- Upholstered seats can match or contrast
- Antibacterial and antimicrobial fabrics available
- CAL 133
- One connecting plate per unit to connect to other Tailor products, add \$43 List per plate
- Cove Mini power module centered in the seat front is available in Black, Silver Pearl and Gloss White. Add \$426 List per seat per module



Cove Mini

Single Seat Bench

COM 1.25 yds

| MODEL | COM | GR 1 | GR 2 | GR 3 | GR 4 | GR 5 | GR 6 |
|--------------|------------|------------|------------|------------|------------|------------|-------------|
| 9101B | 693 | 761 | 784 | 832 | 902 | 957 | 1028 |

Dimensions (inches)

| | | | | | | | |
|---------|------|---------|------|-------|------|--|--|
| seat H | 18.0 | seat W | 23.0 | | | | |
| total H | 18.0 | total W | 23.0 | depth | 20.0 | | |

Exceeds BIFMA Seating Durability Test to 500 lbs
CAL 133, add \$105 List per unit



9101B
26 lbs

Two Seat Bench

COM 2.5 yds
1.25 yds COM per single seat

| MODEL | COM | GR 1 | GR 2 | GR 3 | GR 4 | GR 5 | GR 6 |
|--------------|------------|-------------|-------------|-------------|-------------|-------------|-------------|
| 9102B | 976 | 1114 | 1158 | 1254 | 1395 | 1503 | 1646 |

Dimensions (inches)

| | | | | | | | |
|---------|------|---------|------|-------|------|--|--|
| seat H | 18.0 | seat W | 23.0 | | | | |
| total H | 18.0 | total W | 46.0 | depth | 20.0 | | |

Exceeds BIFMA Seating Durability Test to 570 lbs
CAL 133, add \$209 List per unit



9102B
57 lbs



TAILOR Lounge Collection - BENCH

Standard Features

- One piece seat upholstery for easier maintenance
- Non wall-saving frame
- Glides
- Ships assembled
- Ships 1 three seat bench per carton, 29 cu ft

Contact Spec Customer Service to railroad fabrics (specify repeat info and yardage requirement will be provided) and for repeats greater than 5" x 5".



Non Wall-saving Frame

Options

- Upholstered seats can match or contrast
- Antibacterial and antimicrobial fabrics available
- CAL 133
- One connecting plate per unit to connect to other Tailor products, add \$43 List per plate
- Cove Mini power module centered in the seat front is available in Black, Silver Pearl and Gloss White. Add \$426 List per seat per module



Cove Mini

Three Seat Bench

COM 3.75 yds
1.25 yds COM per single seat

| MODEL | COM | GR 1 | GR 2 | GR 3 | GR 4 | GR 5 | GR 6 |
|--------------|-------------|-------------|-------------|-------------|-------------|-------------|-------------|
| 9103B | 1272 | 1478 | 1544 | 1689 | 1899 | 2062 | 2277 |

Dimensions (inches)

| | | | | | |
|---------|------|---------|------|-------|------|
| seat H | 18.0 | seat W | 23.0 | | |
| total H | 18.0 | total W | 69.0 | depth | 20.0 |

Exceeds BIFMA Seating Durability Test to 750 lbs
CAL 133, add \$314 List per unit



9103B
100 lbs

TAILOR Lounge Collection - MODULAR



PRODUCT CODE

91 01 MC - NA

| | | | |
|------------------------------|---|--|---|
| Series 91 : Tailor | Number of Seats 1 : Single Seat 2 : Two Seat 3 : Three Seat | Type MC : Mid-Back Connected | Arms NA : No Arm L : Left Arm R : Right Arm |
|------------------------------|---|--|---|

OPTIONS

ARM GAP



ARM CAP



POWER



In table



In seat

FINISHES

FRAME



Select from one of our 76 standard Spectone colors

FABRIC



Select fabrics from one of our textile partners

LAMINATE

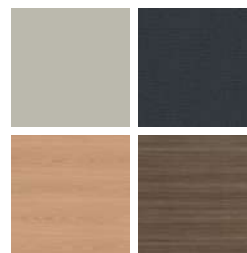

Select from 15 standard laminates or choose any standard Wilsonart, Nevamar, Formica, Arborite and Pionite matte finish laminates at no upcharge

EDGE



SE

ARM CAPS



Polyurethane

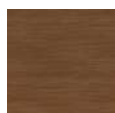

Wood*

*Wood arms are available in 9 standard stains or stain-to-match at no upcharge.



TAILOR Lounge Collection - MODULAR

HOW TO ORDER

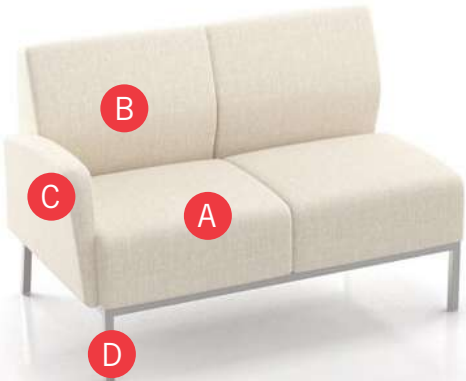

Specify Model

- A** Specify Fabric - Seat¹
Manufacturer, Pattern Name, Color
- B** Specify Fabric - Back¹
Manufacturer, Pattern Name, Color
- C** Specify Fabric - Arms¹
Manufacturer, Pattern Name, Color
- D** Specify Frame Finish

Optional: CAL 133, Moisture Barrier, 1" Gap Between Seat and Arm, Arm Caps, Connecting and Freestanding Tables, Power

Restrictions may apply. See price list tables below for more information.

¹ When multiple fabrics are specified on two and three seat chairs, please provide a drawing and legend for fabric placement.



| Model | Fabric - Seat 1 | Fabric - Seat 2 | Fabric - Back 1 | Fabric - Back 2 | Fabric - Arm 1 | Frame Finish |
|----------|---------------------------|---------------------------|---------------------------|---------------------------|---------------------------|--------------|
| 9102MC-L | Momentum, Beeline, Canvas | Momentum, Beeline, Canvas | Momentum, Beeline, Canvas | Momentum, Beeline, Canvas | Momentum, Beeline, Canvas | Silver |

TAILOR Lounge Collection - MODULAR LAYOUTS

To configure Tailor Modular, please specify left to right facing the configuration.

Tailor has two arm styles - end arms which are tapered, and connecting arms which are straight. Please provide a layout drawing with your purchase order or quote request and Customer Service will determine the appropriate arm (end or connecting) depending on their position within the layout. Arms are shipped assembled on the chair.



Tapered End Arm



Straight Connecting Arm

- A** Choose from one-, two-, three-seat and bariatric modular designs.

Note: Single seat configuration is shown in the example below.

- B** Tapered End Arms are installed at the ends of the layout run.

Note: Exceptions apply, see next page for more information.

- C** When arms are specified between seats or seat-to-table, a Straight Connecting Arm will be used.

- D** To complete your configuration, choose from end of run, spacer or corner connecting tables.

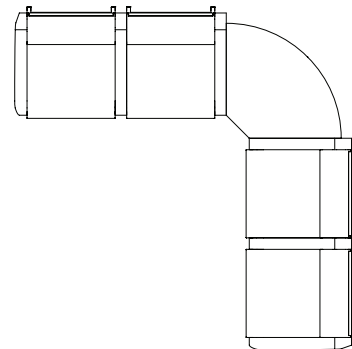
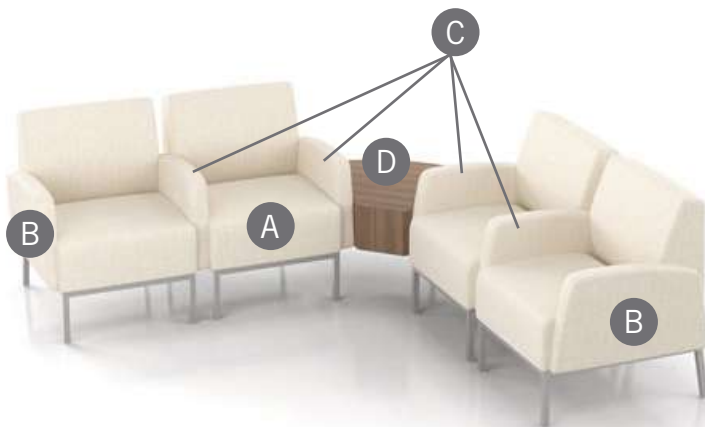

The configuration above can be specified as:

- 9101MC Single Seat, Two Arms (one Tapered End, one Straight Connecting)
- 9101MC-R Single Seat, With Right Arm Only (Straight Connecting)
- 91RC Corner Table - Radius Corner
- 9101MC Single Seat, Two Arms (two Straight Connecting)
- 9101MC-R Single Seat, With Right Arm Only (Tapered End)

TAILOR Lounge Collection - MODULAR

TAPERED END ARMS ON BOTH ENDS

Configurations with **arms on both ends** will have Tapered End Arms as standard.



Configuration above shows Tapered End Arms on outside of chairs, Straight Connecting Arms in center. Regardless of its complexity, when a configuration is ending in arms on both ends, the configuration will be specified with a Tapered End Arm as standard.

- A Tapered End Arm
- B Straight Connecting Arm

STRAIGHT CONNECTING ARM ON ONE END

Configurations with an **arm on one end** will have Straight Connecting Arm as standard.



Configuration above is ending in a table on one end, and an arm on the other end of the run. Regardless of its complexity, when a configuration is ending in one arm only, the configuration will be specified with a Straight Connecting Arm as standard. Customers may specify Tapered End Arm at the end of such run, but a special note must be given to Customer Service at the time of quote/order. Note that the arm beside the table will always be a Straight Connecting Arm.

TAILOR Lounge Collection - MODULAR

FOUR SEAT DESIGN, EXAMPLE 1

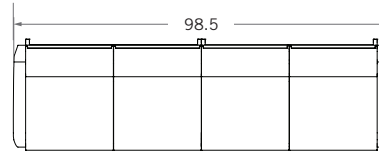
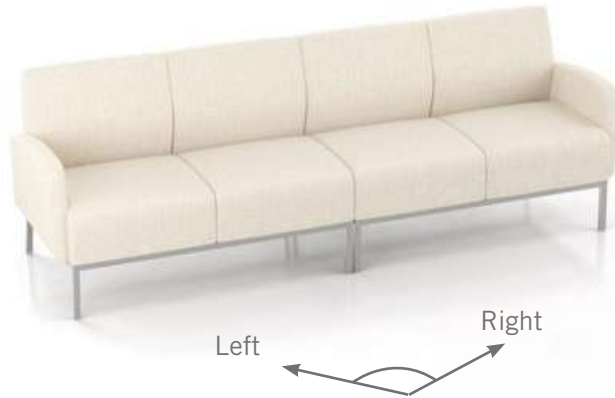

A four-seat configuration may be specified as two two-seat sofas.

- 9102MC-L Two Seat, With Left Arm Only (Tapered End)
- 9102MC-R Two Seat, With Right Arm Only (Tapered End)

FOUR SEAT DESIGN, EXAMPLE 2

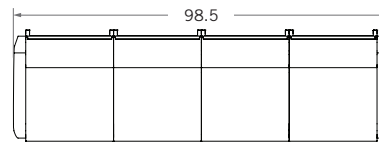

A four-seat configuration may also be specified as four single seat chairs. Please note that the number of legs in this case is double than in the example above.

Note: Specifying with single seats allows for higher flexibility, but this also increases the number of legs.

- 9101MC-L Single Seat, With Left Arm Only (Tapered End)
- 9101MC-NA Single Seat, Without Arms
- 9101MC-NA Single Seat, Without Arms
- 9101MC-R Single Seat, With Right Arm Only (Tapered End)

FOUR SEAT DESIGN, EXAMPLE 3

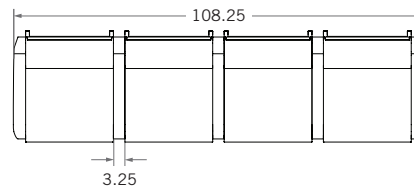

Arms may be added between each seat, increasing the gap between each chair base, as well as the overall width of the configuration.

- 9101MC Single Seat, Two Arms (one Tapered End, one Straight Connecting)
- 9101MC-R Single Seat, With Right Arm Only (Straight Connecting)
- 9101MC-R Single Seat, With Right Arm Only (Straight Connecting)
- 9101MC-R Single Seat, With Right Arm Only (Tapered End)

TAILOR Lounge Collection - MODULAR

END TABLE ON BOTH ENDS, EXAMPLE

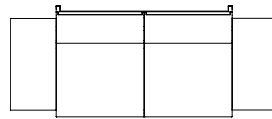
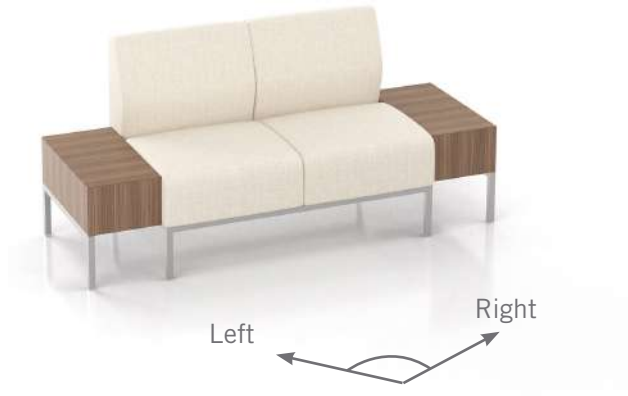

91ERC - 24 x 12
 9102MC-NA
 91ERC - 24 x 12

End of Run Table Closed - Half Size
 Two Seat, Without Arms
 End of Run Table Closed - Half Size

SPACER TABLE BETWEEN SEATS, EXAMPLE

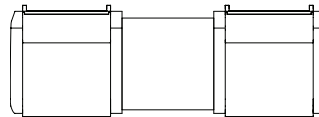
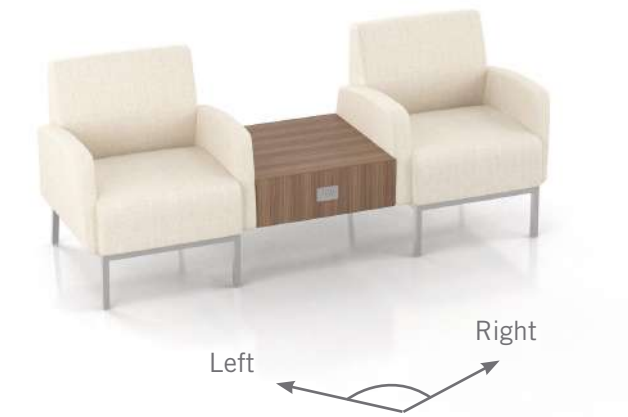

9101MC
 91STC - 24 x 24
 COV-1U-S
 9101MC

Single Seat, Two Arms
 (one Tapered End, one Straight Connecting)
 Spacer Table Closed - Full Size
 Cove, 1 power, 2USB, Silver Pearl
 Single Seat, Two Arms
 (one Straight Connecting, one Tapered End)

TAILOR Lounge Collection - MODULAR

Standard Features

- Separate seat and back
- Wall-saving frame
- Glides
- One connecting plate per unit
- Ships assembled, 1/carton 24 cu ft

Contact Spec Customer Service to railroad fabrics (specify repeat info and yardage requirement will be provided) and for repeats greater than 5" x 5"

To ensure proper configuration please provide a layout drawing.



Wall-saving Frame

Options

- Polyurethane arm caps available in Black (B), Taupe RAL 7006 (T) or Sterling Grey (G), add \$118 List per arm
- For wood arm caps, select from 9 standard stains, or stain-to-match at no upcharge, add \$139 List per arm
- 1" gap between seat and arm available at \$48 List per arm
- Upholstered arms/seat/back can match or contrast
- Cove Mini power module centered in the seat front is available in Black, Silver Pearl and Gloss White. Add \$426 List per seat per module
- Antibacterial and antimicrobial fabrics available
- CAL 133



Tapered End Arm



Straight Connecting Arm



Cove Mini

Single Seat, Without Arms

COM 2.75 yds
 1.25 yds COM per single seat
 1.5 yds COM per single back

| MODEL | COM | GR 1 | GR 2 | GR 3 | GR 4 | GR 5 | GR 6 |
|------------------|------------|-------------|-------------|-------------|-------------|-------------|-------------|
| 9101MC-NA | 962 | 1109 | 1156 | 1258 | 1408 | 1525 | 1676 |

Dimensions (inches)
 seat H 18.0 seat W 23.0
 total H 33.0 total W 23.0 depth 29.0

Exceeds BIFMA Seating Durability Test to 500 lbs
 CAL 133, add \$209 List per unit



9101MC-NA
43 lbs

Single Seat, Two Arms

COM 4.25 yds
 1.25 yds COM per single seat
 1.5 yds COM per single back
 0.75 yds COM per arm

| MODEL | COM | GR 1 | GR 2 | GR 3 | GR 4 | GR 5 | GR 6 |
|---------------|-------------|-------------|-------------|-------------|-------------|-------------|-------------|
| 9101MC | 1468 | 1698 | 1773 | 1931 | 2166 | 2346 | 2583 |

Dimensions (inches)
 seat H 18.0 seat W 23.0 arm H 24.5
 total H 33.0 total W 29.5 depth 29.0

Exceeds BIFMA Seating Durability Test to 500 lbs
 CAL 133, add \$323 List per unit



9101MC
67 lbs

TAILOR Lounge Collection - MODULAR

Standard Features

- Separate seat and back
- Wall-saving frame
- Glides
- One connecting plate per unit
- Ships assembled, 1/carton 24 cu ft

Contact Spec Customer Service to railroad fabrics (specify repeat info and yardage requirement will be provided) and for repeats greater than 5" x 5"

To ensure proper configuration please provide a layout drawing.



Wall-saving Frame

Options

- Polyurethane arm caps available in Black (B), Taupe RAL 7006 (T) or Sterling Grey (G), add \$118 List per arm
- For wood arm caps, select from 9 standard stains, or stain-to-match at no upcharge, add \$139 List per arm
- 1" gap between seat and arm available at \$48 List per arm
- Upholstered arms/seat/back can match or contrast
- Cove Mini power module centered in the seat front is available in Black, Silver Pearl and Gloss White. Add \$426 List per seat per module
- Antibacterial and antimicrobial fabrics available
- CAL 133



Tapered End Arm



Straight Connecting Arm



Cove Mini

Single Seat, With Right Arm Only

COM 3.5 yds
 1.25 yds COM per single seat
 1.5 yds COM per single back
 0.75 yds COM per arm

| MODEL | COM | GR 1 | GR 2 | GR 3 | GR 4 | GR 5 | GR 6 |
|-----------------|-------------|-------------|-------------|-------------|-------------|-------------|-------------|
| 9101MC-R | 1215 | 1403 | 1465 | 1595 | 1787 | 1934 | 2130 |

Dimensions (inches)

| | | | | | |
|---------|------|---------|-------|-------|------|
| seat H | 18.0 | seat W | 23.0 | arm H | 24.5 |
| total H | 33.0 | total W | 26.25 | depth | 29.0 |

Exceeds BIFMA Seating Durability Test to 500 lbs
 CAL 133, add \$266 List per unit



9101MC-R
55 lbs

Single Seat, With Left Arm Only

COM 3.5 yds
 1.25 yds COM per single seat
 1.5 yds COM per single back
 0.75 yds COM per arm

| MODEL | COM | GR 1 | GR 2 | GR 3 | GR 4 | GR 5 | GR 6 |
|-----------------|-------------|-------------|-------------|-------------|-------------|-------------|-------------|
| 9101MC-L | 1215 | 1403 | 1465 | 1595 | 1787 | 1934 | 2130 |

Dimensions (inches)

| | | | | | |
|---------|------|---------|-------|-------|------|
| seat H | 18.0 | seat W | 23.0 | arm H | 24.5 |
| total H | 33.0 | total W | 26.25 | depth | 29.0 |

Exceeds BIFMA Seating Durability Test to 500 lbs
 CAL 133, add \$266 List per unit



9101MC-L
55 lbs



TAILOR Lounge Collection - MODULAR

Standard Features

- Separate seat and back
- Wall-saving frame
- Glides
- One connecting plate per unit
- Ships assembled, 1/carton 32 cu ft

Contact Spec Customer Service to railroad fabrics (specify repeat info and yardage requirement will be provided) and for repeats greater than 5" x 5"

To ensure proper configuration please provide a layout drawing.



Wall-saving Frame

Options

- Polyurethane arm caps available in Black (B), Taupe RAL 7006 (T) or Sterling Grey (G), add \$118 List per arm
- For wood arm caps, select from 9 standard stains, or stain-to-match at no upcharge, add \$139 List per arm
- 1" gap between seat and arm available at \$48 List per arm
- Upholstered arms/seat/back can match or contrast
- Cove Mini power module centered in the seat front is available in Black, Silver Pearl and Gloss White. Add \$426 List per seat per module
- Antibacterial and antimicrobial fabrics available
- CAL 133



Tapered End Arm



Straight Connecting Arm



Cove Mini

Bariatric Single Seat, Two Arms

COM 5 yds
 1.5 yds COM per single seat
 2 yds COM per single back
 0.75 yds COM per arm

| MODEL | COM | GR 1 | GR 2 | GR 3 | GR 4 | GR 5 | GR 6 |
|---------------|-------------|-------------|-------------|-------------|-------------|-------------|-------------|
| 9101GC | 1604 | 1858 | 1949 | 2137 | 2417 | 2631 | 2915 |

Dimensions (inches)

| | | | | | |
|---------|------|---------|------|-------|------|
| seat H | 18.0 | seat W | 30.0 | arm H | 24.5 |
| total H | 33.0 | total W | 36.5 | depth | 29.0 |

Exceeds BIFMA Seating Durability Test to 750 lbs
 CAL 133, add \$381 List per unit



9101GC
75 lbs

TAILOR Lounge Collection - MODULAR

Standard Features

- Separate seat and back
- Wall-saving frame
- Glides
- One connecting plate per unit
- Ships assembled, 1/carton 43 cu ft

Contact Spec Customer Service to railroad fabrics (specify repeat info and yardage requirement will be provided) and for repeats greater than 5" x 5"

To ensure proper configuration please provide a layout drawing.



Wall-saving Frame

Options

- Polyurethane arm caps available in Black (B), Taupe RAL 7006 (T) or Sterling Grey (G), add \$118 List per arm
- For wood arm caps, select from 9 standard stains, or stain-to-match at no upcharge, add \$139 List per arm
- 1" gap between seat and arm available at \$48 List per arm
- Upholstered arms/seat/back can match or contrast
- Cove Mini power module centered in the seat front is available in Black, Silver Pearl and Gloss White. Add \$426 List per seat per module
- Antibacterial and antimicrobial fabrics available
- CAL 133



Tapered End Arm



Straight Connecting Arm



Cove Mini

Two Seat, Without Arms

COM 5.5 yds
 1.25 yds COM per single seat
 1.5 yds COM per single back

| MODEL | COM | GR 1 | GR 2 | GR 3 | GR 4 | GR 5 | GR 6 |
|------------------|-------------|-------------|-------------|-------------|-------------|-------------|-------------|
| 9102MC-NA | 1671 | 1966 | 2062 | 2265 | 2566 | 2796 | 3101 |

Dimensions (inches)
 seat H 18.0 seat W 23.0
 total H 33.0 total W 46.0 depth 29.0

Exceeds BIFMA Seating Durability Test to 570 lbs
 CAL 133, add \$418 List per unit



9102MC-NA
92 lbs

Two Seat, With Two Arms

COM 7 yds
 1.25 yds COM per single seat
 1.5 yds COM per single back
 0.75 yds COM per arm

| MODEL | COM | GR 1 | GR 2 | GR 3 | GR 4 | GR 5 | GR 6 |
|---------------|-------------|-------------|-------------|-------------|-------------|-------------|-------------|
| 9102MC | 2178 | 2555 | 2678 | 2938 | 3323 | 3617 | 4008 |

Dimensions (inches)
 seat H 18.0 seat W 23.0 arm H 24.5
 total H 33.0 total W 52.5 depth 29.0

Exceeds BIFMA Seating Durability Test to 570 lbs
 CAL 133, add \$532 List per unit



9102MC
116 lbs

TAILOR Lounge Collection - MODULAR

Standard Features

- Separate seat and back
- Wall-saving frame
- Glides
- One connecting plate per unit
- Ships assembled, 1/carton 43 cu ft

Contact Spec Customer Service to railroad fabrics (specify repeat info and yardage requirement will be provided) and for repeats greater than 5" x 5"

To ensure proper configuration please provide a layout drawing.



Wall-saving Frame

Options

- Polyurethane arm caps available in Black (B), Taupe RAL 7006 (T) or Sterling Grey (G), add \$118 List per arm
- For wood arm caps, select from 9 standard stains, or stain-to-match at no upcharge, add \$139 List per arm
- 1" gap between seat and arm available at \$48 List per arm
- Upholstered arms/seat/back can match or contrast
- Cove Mini power module centered in the seat front is available in Black, Silver Pearl and Gloss White. Add \$426 List per seat per module
- Antibacterial and antimicrobial fabrics available
- CAL 133



Tapered End Arm



Straight Connecting Arm



Cove Mini

Two Seat, With Right Arm Only

COM 6.25 yds
 1.25 yds COM per single seat
 1.5 yds COM per single back
 0.75 yds COM per arm

| MODEL | COM | GR 1 | GR 2 | GR 3 | GR 4 | GR 5 | GR 6 |
|----------|------|------|------|------|------|------|------|
| 9102MC-R | 1925 | 2260 | 2370 | 2602 | 2943 | 3207 | 3555 |

Dimensions (inches)
 seat H 18.0 seat W 23.0 arm H 24.5
 total H 33.0 total W 49.25 depth 29.0

Exceeds BIFMA Seating Durability Test to 570 lbs
 CAL 133, add \$475 List per unit



9102MC-R
104 lbs

Two Seat, With Left Arm Only

COM 6.25 yds
 1.25 yds COM per single seat
 1.5 yds COM per single back
 0.75 yds COM per arm

| MODEL | COM | GR 1 | GR 2 | GR 3 | GR 4 | GR 5 | GR 6 |
|----------|------|------|------|------|------|------|------|
| 9102MC-L | 1925 | 2260 | 2370 | 2602 | 2943 | 3207 | 3555 |

Dimensions (inches)
 seat H 18.0 seat W 23.0 arm H 24.5
 total H 33.0 total W 49.25 depth 29.0

Exceeds BIFMA Seating Durability Test to 570 lbs
 CAL 133, add \$475 List per unit



9102MC-L
104 lbs



TAILOR Lounge Collection - MODULAR

Standard Features

- Separate seat and back
- Wall-saving frame
- Glides
- One connecting plate per unit
- Ships assembled, 1/carton 62 cu ft

Contact Spec Customer Service to railroad fabrics (specify repeat info and yardage requirement will be provided) and for repeats greater than 5" x 5"

To ensure proper configuration please provide a layout drawing.



Wall-saving Frame

Options

- Polyurethane arm caps available in Black (B), Taupe RAL 7006 (T) or Sterling Grey (G), add \$118 List per arm
- For wood arm caps, select from 9 standard stains, or stain-to-match at no upcharge, add \$139 List per arm
- 1" gap between seat and arm available at \$48 List per arm
- Upholstered arms/seat/back can match or contrast
- Cove Mini power module centered in the seat front is available in Black, Silver Pearl and Gloss White. Add \$426 List per seat per module
- Antibacterial and antimicrobial fabrics available
- CAL 133



Tapered End Arm



Straight Connecting Arm



Cove Mini

Three Seat, Without Arms

COM 8.25 yds
 1.25 yds COM per single seat
 1.5 yds COM per single back

| MODEL | COM | GR 1 | GR 2 | GR 3 | GR 4 | GR 5 | GR 6 |
|------------------|-------------|-------------|-------------|-------------|-------------|-------------|-------------|
| 9103MC-NA | 2382 | 2823 | 2967 | 3273 | 3722 | 4068 | 4526 |

Dimensions (inches)
 seat H 18.0 seat W 23.0
 total H 33.0 total W 69.0 depth 29.0

Exceeds BIFMA Seating Durability Test to 750 lbs
 CAL 133, add \$627 List per unit



9103MC-NA
137 lbs

Three Seat, With Two Arms

COM 9.75 yds
 1.25 yds COM per single seat
 1.5 yds COM per single back
 0.75 yds COM per arm

| MODEL | COM | GR 1 | GR 2 | GR 3 | GR 4 | GR 5 | GR 6 |
|---------------|-------------|-------------|-------------|-------------|-------------|-------------|-------------|
| 9103MC | 2888 | 3412 | 3583 | 3945 | 4479 | 4890 | 5433 |

Dimensions (inches)
 seat H 18.0 seat W 23.0 arm H 24.5
 total H 33.0 total W 75.5 depth 29.0

Exceeds BIFMA Seating Durability Test to 750 lbs
 CAL 133, add \$741 List per unit



9103MC
161 lbs

TAILOR Lounge Collection - MODULAR

Standard Features

- Separate seat and back
- Wall-saving frame
- Glides
- One connecting plate per unit
- Ships assembled, 1/carton 62 cu ft

Contact Spec Customer Service to railroad fabrics (specify repeat info and yardage requirement will be provided) and for repeats greater than 5" x 5"

To ensure proper configuration please provide a layout drawing.



Wall-saving Frame

Options

- Polyurethane arm caps available in Black (B), Taupe RAL 7006 (T) or Sterling Grey (G), add \$118 List per arm
- For wood arm caps, select from 9 standard stains, or stain-to-match at no upcharge, add \$139 List per arm
- 1" gap between seat and arm available at \$48 List per arm
- Upholstered arms/seat/back can match or contrast
- Cove Mini power module centered in the seat front is available in Black, Silver Pearl and Gloss White. Add \$426 List per seat per module
- Antibacterial and antimicrobial fabrics available
- CAL 133



Tapered End Arm



Straight Connecting Arm



Cove Mini

Three Seat, With Right Arm Only

COM 9 yds
 1.25 yds COM per single seat
 1.5 yds COM per single back
 0.75 yds COM per arm

| MODEL | COM | GR 1 | GR 2 | GR 3 | GR 4 | GR 5 | GR 6 |
|-----------------|-------------|-------------|-------------|-------------|-------------|-------------|-------------|
| 9103MC-R | 2634 | 3117 | 3276 | 3609 | 4101 | 4478 | 4978 |

Dimensions (inches)
 seat H 18.0 seat W 23.0 arm H 24.5
 total H 33.0 total W 72.25 depth 29.0

Exceeds BIFMA Seating Durability Test to 750 lbs
 CAL 133, add \$684 List per unit



9103MC-R
149 lbs

Three Seat, With Left Arm Only

COM 9 yds
 1.25 yds COM per single seat
 1.5 yds COM per single back
 0.75 yds COM per arm

| MODEL | COM | GR 1 | GR 2 | GR 3 | GR 4 | GR 5 | GR 6 |
|-----------------|-------------|-------------|-------------|-------------|-------------|-------------|-------------|
| 9103MC-L | 2634 | 3117 | 3276 | 3609 | 4101 | 4478 | 4978 |

Dimensions (inches)
 seat H 18.0 seat W 23.0 arm H 24.5
 total H 33.0 total W 72.25 depth 29.0

Exceeds BIFMA Seating Durability Test to 750 lbs
 CAL 133, add \$684 List per unit



9103MC-L
149 lbs



TAILOR Lounge Collection - MODULAR TABLES

Standard Features

- Tables in laminate or veneer
- Select laminate tops from 15 standard laminates or choose any standard Wilsonart, Nevamar, Formica, Arborite and Pionite matte finish laminates at no upcharge.
- 9 standard veneers. Stain-to-match available at no upcharge.
- Tables available with Self Edge (SE) only
- Steel table legs available in any Spectone color
- Tops utilize NU Green earth friendly core
- Glides
- One connecting plate per unit
- Ships KD
- 17" height

Options

- To add Cove Mini, clamp mounted with 1 power, 2 USB (charging only), and a 108" long cord to Tailor modular tables, add \$344 List. Cove will be located on the flat front face of the closed tables as standard. It is not recommended to specify power on open tables. Specify separately at time of order.



- Black **COVSMC1P1U-B**
- Silver Pearl **COVSMC1P1U-S**
- Gloss White **COVSMC1P1U-W**

To ensure proper configuration please provide a layout drawing.

Corner and Spacer Connecting Tables

| Model | | Laminate SE | Veneer SE | Weight | Cu.Ft. |
|---------------|-------------------------------------|-------------|-----------|--------|--------|
| 91STC - 24X24 | SPACER TABLE CLOSED - FULL SIZE | 830 | 1163 | 32 | 11 |
| 91STO - 24X24 | SPACER TABLE OPEN - FULL SIZE | 852 | 1192 | 30 | 11 |
| 91STC - 24X12 | SPACER TABLE CLOSED - HALF SIZE | 777 | 1087 | 20 | 7 |
| 91STO - 24X12 | SPACER TABLE OPEN - HALF SIZE | 798 | 1117 | 20 | 7 |
| 91ERC - 24X24 | END OF RUN TABLE CLOSED - FULL SIZE | 1002 | 1402 | 33 | 11 |
| 91ERO - 24X24 | END OF RUN TABLE OPEN - FULL SIZE | 1023 | 1432 | 31 | 11 |
| 91ERC - 24X12 | END OF RUN TABLE CLOSED - HALF SIZE | 948 | 1327 | 21 | 7 |
| 91ERO - 24X12 | END OF RUN TABLE OPEN - HALF SIZE | 969 | 1357 | 21 | 7 |
| 91ERB | END OF RUN TABLE - BULLET | 1090 | 1526 | 36 | 14 |
| 91HM | END OF RUN TABLE - HALF-MOON | 1456 | 2231 | 75 | 25 |
| 91RC | CORNER TABLE - 90 RADIUS CORNER | 1090 | 1526 | 45 | 16 |
| 91RC45 | CORNER TABLE - 45 RADIUS CORNER | 1090 | 1526 | 32 | 12 |



91STC - 24 x 24
32 lbs



91STO - 24 x 24
30 lbs



91STC - 24 x 12
20 lbs



91STO - 24 x 12
20 lbs



91RC
45 lbs



91RC45
32 lbs



91ERC - 24 x 24
33 lbs



91ERO - 24 x 24
31 lbs



91ERC - 24 x 12
21 lbs



91ERO - 24 x 12
21 lbs



91ERB
36 lbs



91HM
75 lbs

TAILOR Lounge Collection - BOOTH



PRODUCT CODE

91 03 HB

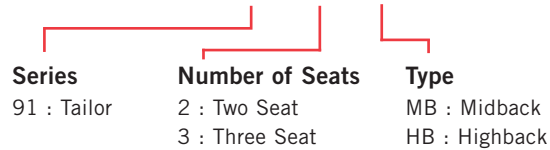

FINISHES

FRAME



Select from one of our 76 standard Spectone colors

FABRIC



Select fabrics from one of our textile partners

POWER



In seat

HOW TO ORDER

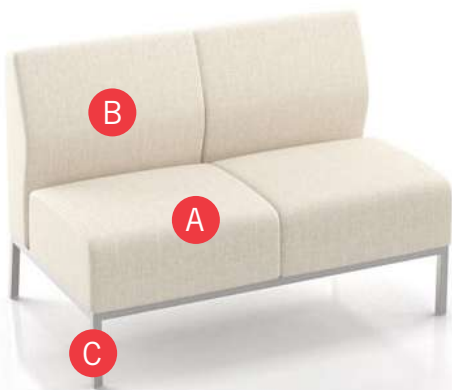

Specify Model

- A** Specify Fabric - Seat¹
Manufacturer, Pattern Name, Color
- B** Specify Fabric - Back¹
Manufacturer, Pattern Name, Color
- C** Specify Frame Finish

Optional: CAL 133, Moisture Barrier, Freestanding Tables, Leveling Glides, Power

¹ When multiple fabrics are specified, please provide a drawing and legend for fabric placement.

| Model | Fabric - Seat | Fabric - Back 1 | Fabric - Back 2 | Frame Finish |
|--------|---------------------------|---------------------------|---------------------------|--------------|
| 9102MB | Momentum, Beeline, Canvas | Momentum, Beeline, Canvas | Momentum, Beeline, Canvas | Silver |

TAILOR Lounge Collection - BOOTH

MIDBACK

Standard Features

- Separate seat and back
- Single piece seat upholstery for easier maintenance
- Non wall-saving frame
- Glides
- Ships assembled
- Ships 1 two seat sofa per carton, 43 cu ft
- Ships 1 three seat sofa per carton, 62 cu ft

Contact Spec Customer Service to railroad fabrics (specify repeat info and yardage requirement will be provided) and for repeats greater than 5" x 5"

Options

- For an individually sewn seat upholstery that creates a gap between seats, call Customer Service
- Leveling glides with inserts (set of 4) are available, add \$20 List
- Upholstered seat/back can match or contrast
- Cove Mini power module centered in the seat front is available in Black, Silver Pearl and Gloss White. Add \$426 List per seat per module
- Antibacterial and antimicrobial fabrics available
- CAL 133



Non Wall-saving Frame

To ensure proper configuration please provide a layout drawing.



Cove Mini

Two Seat, Midback Booth

COM 5.5 yds
 2.5 yds COM per two seater one-piece seat
 3.0 yds COM per two seater two-piece back (1.5 yds COM per single back)

| MODEL | COM | GR 1 | GR 2 | GR 3 | GR 4 | GR 5 | GR 6 |
|---------------|-------------|-------------|-------------|-------------|-------------|-------------|-------------|
| 9102MB | 1659 | 1923 | 2007 | 2191 | 2461 | 2668 | 2940 |

Dimensions (inches)

| | | | | | | | |
|---------|------|---------|------|-------|-------|--|--|
| seat H | 18.0 | seat W | 23.0 | | | | |
| total H | 33.0 | total W | 46.0 | depth | 27.50 | | |

Exceeds BIFMA Seating Durability Test to 570 lbs
 CAL 133, add \$418 List per unit



Three Seat, Midback Booth

COM 8.25 yds
 3.75 yds COM per three seater one-piece seat
 4.5 yds COM per three seater three-piece back (1.5 yds COM per single back)

| MODEL | COM | GR 1 | GR 2 | GR 3 | GR 4 | GR 5 | GR 6 |
|---------------|-------------|-------------|-------------|-------------|-------------|-------------|-------------|
| 9103MB | 2401 | 2780 | 2901 | 3165 | 3548 | 3846 | 4238 |

Dimensions (inches)

| | | | | | | | |
|---------|------|---------|------|-------|-------|--|--|
| seat H | 18.0 | seat W | 23.0 | | | | |
| total H | 33.0 | total W | 69.0 | depth | 27.50 | | |

Exceeds BIFMA Seating Durability Test to 750 lbs
 CAL 133, add \$627 List per unit



TAILOR Lounge Collection - BOOTH

HIGHBACK

Standard Features

- Separate seat and back
- Single piece seat upholstery for easier maintenance
- Non wall-saving frame
- Glides
- Ships assembled
- Ships 1 two seat sofa per carton, 55 cu ft
- Ships 1 three seat sofa per carton, 79 cu ft

Contact Spec Customer Service to railroad fabrics (specify repeat info and yardage requirement will be provided) and for repeats greater than 5" x 5"

Options

- For an individually sewn seat upholstery that creates a gap between seats, call Customer Service
- Leveling glides with inserts (set of 4) are available, add \$20 List
- Upholstered seat/back can match or contrast
- Cove Mini power module centered in the seat front is available in Black, Silver Pearl and Gloss White. Add \$426 List per seat per module
- Antibacterial and antimicrobial fabrics available
- CAL 133



To ensure proper configuration please provide a layout drawing.



Non Wall-saving Frame

Cove Mini

Two Seat, Highback Booth

COM 7.0 yds
 2.5 yds COM per two seater one-piece seat
 4.5 yds COM per two seater two-piece back (2.25 yds COM per single back)

| MODEL | COM | GR 1 | GR 2 | GR 3 | GR 4 | GR 5 | GR 6 |
|---------------|-------------|-------------|-------------|-------------|-------------|-------------|-------------|
| 9102HB | 1894 | 2265 | 2386 | 2644 | 3023 | 3316 | 3700 |

Dimensions (inches)

| | | | | | | | |
|---------|------|---------|------|-------|-------|--|--|
| seat H | 18.0 | seat W | 23.0 | | | | |
| total H | 44.0 | total W | 46.0 | depth | 27.50 | | |

Exceeds BIFMA Seating Durability Test to 570 lbs
 CAL 133, add \$543 List per unit



9102HB
90 lbs

Three Seat, Highback Booth

COM 10.5 yds
 3.75 yds COM per three seater one-piece seat
 6.75 yds COM per three seater three-piece back (2.25 yds COM per single back)

| MODEL | COM | GR 1 | GR 2 | GR 3 | GR 4 | GR 5 | GR 6 |
|---------------|-------------|-------------|-------------|-------------|-------------|-------------|-------------|
| 9103HB | 2754 | 3294 | 3467 | 3844 | 4393 | 4817 | 5377 |

Dimensions (inches)

| | | | | | | | |
|---------|------|---------|------|-------|-------|--|--|
| seat H | 18.0 | seat W | 23.0 | | | | |
| total H | 44.0 | total W | 69.0 | depth | 27.50 | | |

Exceeds BIFMA Seating Durability Test to 750 lbs
 CAL 133, add \$829 List per unit



9103HB
149 lbs



TAILOR Lounge Collection - BOOTH

TABLES



| MODEL | BASES | | | TOP SPECIFICATIONS | OPTIONS | LBS |
|-------------------|------------|---------|------|-------------------------------|---------|-----|
| | Code | Size | Qty. | | | |
| | | | | For Laminate Top SE 2MM | | |
| <i>Rectangle</i> | | | | | | |
| <i>29" high</i> | | | | | | |
| 30 X 46 RE | TBT | 20 X 36 | 1 | 1340 | | 123 |
| 36 X 46 RE | TBT | 26 X 36 | 1 | 1611 | | 153 |
| 42 X 46 RE | TBT | 32 X 36 | 1 | 2032 | | 183 |
| 30 X 69 RE | TBT | 20 X 27 | 2 | 2311 | | 185 |
| 36 X 69 RE | TBT | 26 X 27 | 2 | 2587 | | 230 |
| 42 X 69 RE | TBT | 32 X 27 | 2 | 3099 | | 276 |



30X46RE TBT

30X69RE TBT

STANDARD FEATURES

- Select from 15 standard laminates or choose any standard Wilsonart, Nevamar, Formica, Arborite and Pionite matte finish laminates at no upcharge. For other laminate please contact the factory for pricing.
- Standard with leveling glides.
- Bases available in any Spectone color.
- Standard 29" table height.
- Ships Knocked Down.

HOW TO ORDER

1. Select Model
2. Select Base
3. Select Edge Style
4. Select Options
5. Select Top Finish
6. Select Edge Finish
7. Select Base Finish

Example: 3046RE - TBT - 2MM



TRAFFIC Public Seating

LAYOUTS



Description

- Today's high traffic public areas demand high durability and low maintenance without sacrificing design.
- Perforated steel seats, with optional field replaceable cushions, can be connected with perforated steel or laminate spacer tables to fit virtually any layout.
- Standard seat width is 22". Bariatric seating is a 30" wide seat and is load tested to 750 lbs.
- Seat, leg column and foot can be specified in different finishes.
- Arms or armless can be specified in any standard width combination.
- Arms only for Bariatric.
- Please send a drawing of the configuration you require with your order.
- Optional floor mounting brackets available.
- Seat mounting option location offers wall-saving if desired.
- For fabrics you wish railroaded or repeats larger than 5" x 5", please contact the factory with repeat information and yardage requirement will be provided.



LAYOUTS AND DIMENSIONS

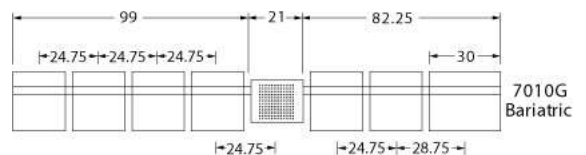
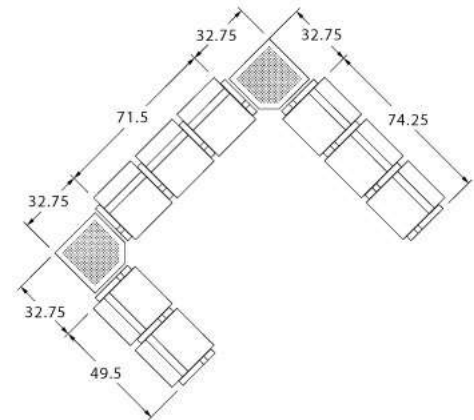
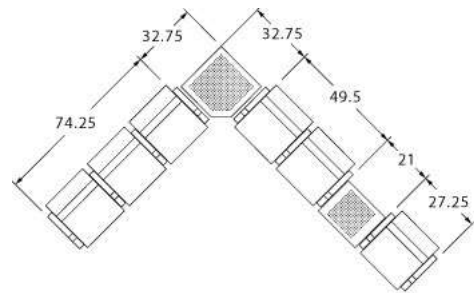

TRAFFIC Public Seating



PRODUCT CODE

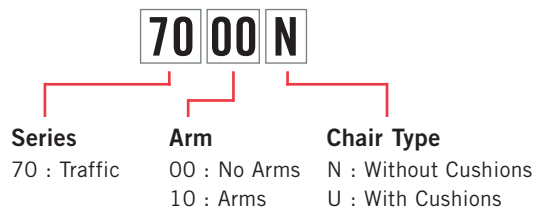

OPTIONS



Without Cushion



With Cushion



With Arms



Without Arms

FINISHES

FRAME



Select from one of our 76 standard Spectone colors

FABRIC



Select fabrics from one of our textile partners

See Spectone Card or specfurniture.com/materials/finishes for a complete list of finish options and colors.

HOW TO ORDER

Specify Model

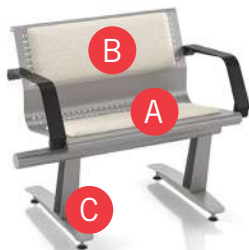

- A** Specify Fabric - Seat, If Applicable
Manufacturer, Pattern Name, Color
- B** Specify Fabric - Back, If Applicable
Manufacturer, Pattern Name, Color
- C** Specify Frame Finish

Optional: CAL 133, Moisture Barrier, Floor Mounting Brackets, Connecting Tables

| Model | Fabric - Seat | Fabric - Back | Frame Finish |
|-------|---------------------------|---------------------------|--------------|
| 7000U | Momentum, Beeline, Canvas | Momentum, Beeline, Canvas | Silver |



TRAFFIC Public Seating

Perforated Beam without arms

Standard Features

- Available with or without replaceable upholstered cushions
- Available with or without black polyurethane arms
- Frame in any Spectone color
- Levelers
- Can be mounted standard or wall-saving
- Ships KD
- Ships 1/carton 11.5 cu ft/seat

Options

- Corner and spacer tables
- Use in connected layouts at no upcharge
- Floor mounting brackets, add \$51 List / leg. Includes 2 brackets per leg.
- Antibacterial and antimicrobial fabrics available
- CAL 133



Prices are per seat and include beam and base

Contact Spec Customer Service to railroad fabrics (specify repeat info and yardage requirement will be provided) and for repeats greater than 5" x 5"



Traffic without arms, without upholstered cushions

N/A COM per single seat

| MODEL | LIST |
|--------------|------------|
| 7000N | 837 |

Dimensions (inches)

| | | | | | |
|---------|-------|---------|-------|-------------------|------|
| seat H | 18.75 | seat W | 22.0 | depth | 25.5 |
| total H | 31.75 | total W | 24.75 | depth wall-saving | 27.5 |

Exceeds BIFMA Seating Durability Test to 500 lbs per seat



7000N
43 lbs/seat

Traffic without arms, with upholstered cushions

0.5 yd COM per single seat and back

| MODEL | COM | GR 1 | GR 2 | GR 3 | GR 4 | GR 5 | GR 6 |
|--------------|------------|------------|------------|------------|------------|-------------|-------------|
| 7000U | 858 | 899 | 915 | 942 | 985 | 1019 | 1060 |

Dimensions (inches)

| | | | | | |
|---------|-------|---------|-------|-------|------|
| seat H | 19.25 | seat W | 22.0 | depth | 25.5 |
| total H | 32.0 | total W | 24.75 | depth | 27.5 |

Exceeds BIFMA Seating Durability Test to 500 lbs per seat
CAL 133, add \$60 List per seat



7000U
44 lbs/seat



TRAFFIC Public Seating

Perforated Beam with arms

Standard Features

- Available with or without replaceable upholstered cushions
- Available with or without black polyurethane arms
- Frame in any Spectone color
- Levelers
- Can be mounted standard or wall-saving
- Ships KD
- Ships 1/carton 11.5 cu ft/seat

Options

- Corner and spacer tables
- Use in connected layouts at no upcharge
- Floor mounting brackets, add \$51 List / leg. Includes 2 brackets per leg.
- Antibacterial and antimicrobial fabrics available
- CAL 133



Prices are per seat and include beam and base

Contact Spec Customer Service to railroad fabrics (specify repeat info and yardage requirement will be provided) and for repeats greater than 5" x 5"



Traffic with arms, without upholstered cushions

N/A COM per single seat

| MODEL | LIST |
|--------------|------------|
| 7010N | 837 |

Dimensions (inches)

| | | | | | |
|---------|-------|---------|-------|-------------------|------|
| seat H | 18.75 | seat W | 22.0 | depth | 25.5 |
| total H | 31.75 | total W | 24.75 | depth wall-saving | 27.5 |

Exceeds BIFMA Seating Durability Test to 500 lbs per seat



7010N
47 lbs/seat

Traffic with arms and upholstered cushions

0.5 yd COM per single seat and back

| MODEL | COM | GR 1 | GR 2 | GR 3 | GR 4 | GR 5 | GR 6 |
|--------------|------------|------------|------------|------------|------------|-------------|-------------|
| 7010U | 858 | 899 | 915 | 942 | 985 | 1019 | 1060 |

Dimensions (inches)

| | | | | | | | |
|---------|-------|---------|-------|-------|-------|-------------------|------|
| seat H | 19.25 | seat W | 22.0 | arm H | 27.25 | | |
| total H | 32.0 | total W | 24.75 | depth | 25.5 | depth wall-saving | 27.5 |

Exceeds BIFMA Seating Durability Test to 500 lbs per seat

CAL 133, add \$60 List per seat



7010U
48 lbs/seat

TRAFFIC Public Seating

Bariatric Perforated Beam with arms

Standard Features

- Available with or without replaceable upholstered cushions
- Black polyurethane arms
- Frame in any Spectone color
- Levelers
- Not available as freestanding unit
- Can be mounted standard or wall-saving
- Cannot connect bariatric seats to bariatric seats
- Ships KD
- Ships 1/carton 11.5 cu ft/seat

Options

- Corner and spacer tables
- Use in connected layouts at no upcharge
- Floor mounting brackets, add \$51 List / leg. Includes 2 brackets per leg.
- Antibacterial and antimicrobial fabrics available
- CAL 133



Prices are per seat and include beam and base

Contact Spec Customer Service to railroad fabrics (specify repeat info and yardage requirement will be provided) and for repeats greater than 5" x 5"

Bariatric Traffic with arms, without upholstered cushions

N/A COM per single seat

| MODEL | COM |
|---------------|-------------|
| 7010NG | 1091 |

Dimensions (inches)

| | | | | | | | |
|---------|-------|---------|-------|-------|-------|-------------------|------|
| seat H | 18.75 | seat W | 30.0 | arm H | 27.25 | | |
| total H | 31.75 | total W | 32.75 | depth | 25.5 | depth wall-saving | 27.5 |

Exceeds BIFMA Seating Durability Test to 750 lbs per seat



7010NG
47 lbs/seat

Bariatric Traffic with arms and upholstered cushions

0.75 yd COM per single seat and back

| MODEL | COM | GR 1 | GR 2 | GR 3 | GR 4 | GR 5 | GR 6 |
|---------------|-------------|-------------|-------------|-------------|-------------|-------------|-------------|
| 7010UG | 1102 | 1163 | 1184 | 1222 | 1282 | 1327 | 1388 |

Dimensions (inches)

| | | | | | | | |
|---------|-------|---------|-------|-------|-------|-------------------|------|
| seat H | 19.25 | seat W | 30.0 | arm H | 27.25 | | |
| total H | 32.0 | total W | 32.75 | depth | 25.5 | depth wall-saving | 27.5 |

Exceeds BIFMA Seating Durability Test to 750 lbs per seat

CAL 133, add \$72 List per seat



7010UG
48 lbs/seat



TRAFFIC Public Seating

Corner and Spacer Connecting Tables

Standard Features

- Select laminate tops from 15 standard laminates or choose any standard Wilsonart, Nevamar, Formica, Arborite and Pionite matte finish laminates at no upcharge.
- Self edge (SE) or PVC Flat (PVF) edge
- Use in connected layouts at no upcharge
- Tops utilize NU Green earth friendly core
- Radius table only available in laminate
- 18" height
- Ships KD

Options

- Non-standard laminates, contact Spec for pricing
- Tops in perforated metal
- Veneer and hardwood edges

Radius Corner Tables are recommended for open areas



Corner and Spacer Connecting Tables

| Model | Laminate PVF/SE | Perforated Metal | Weight | Cu.Ft. |
|--|--------------------|---------------------|-----------|----------|
| 70RC 30 x 30 <i>Radius Corner Table</i> | 702 | N/A | 31 | 3 |
| 70SC 30 x 30 <i>Square Corner Table</i> | 702 | 899 | 32 | 3 |
| 70ST 21 x 21 <i>Spacer or End Table</i> | 676 | 761 | 21 | 3 |

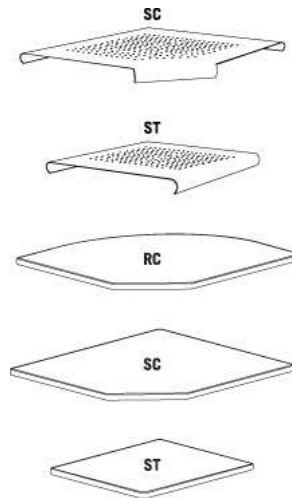



URBAN Public Seating



PRODUCT CODE

14 01 US

Series

14 : Urban

Chair Type

- 01 : Four Point/Arms
- 11 : Four Point/No Arms
- 31 : Sled Base/Arms
- 41 : Sled Base/No Arms
- 02 : Casters/Arms
- 21 : Stool/Arms
- 25 : Stool/No Arms
- 21E : Hip Chair

Upholstery

- N/A : DuraSpec Seat/Plastic Back
- US : Upholstered Seat/Plastic back
- UB : DuraSpec Seat/Upholstered Back
- UP : Fully Upholstered



OPTIONS

SEAT



DuraSpec

Upholstered

BACK



Plastic

Upholstered

S Wood
9 standard stains or stain to match

WALL-SAVING



FINISHES

PLASTIC BACK



Black

Light Grey

White

PLASTIC BACK COVER



Black

Light Grey

White

DURASPEC SEAT



Black

Sterling Grey

FRAME



Select from one of our 76 standard Spectone colors

FABRIC

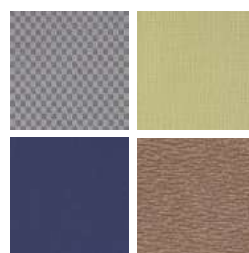

Select fabrics from one of our textile partners

ARMS

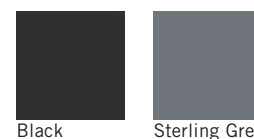

Black

Sterling Grey



URBAN Public Seating - POLY SEAT & PLASTIC BACK

HOW TO ORDER

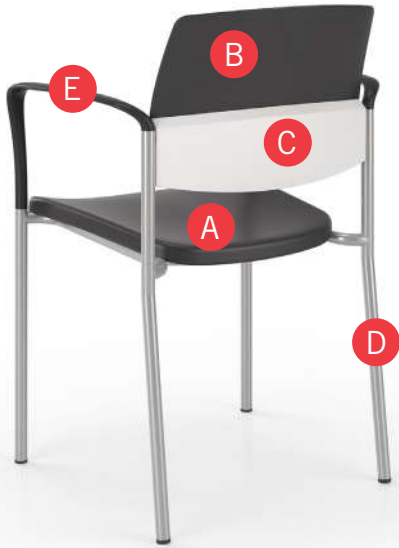

Specify Model

- A** Specify Seat Type and Color
For DuraSpec Seat: Color
- B** Specify Back Type and Color
For Plastic Back: Color
For Wood Back: Wood Stain
- C** Specify Back Panel Color
- D** Specify Frame Finish
- E** Specify Polyurethane Arm Color

Optional: Wood Back, Custom Wood Back Design, Wall-saving Frame, Connecting Bars, Connecting Tables, Dolly

| Model | Seat Type and Color | Back Type and Color | Back Panel Color | Frame Finish | Polyurethane Arm Color |
|-------|---------------------|---------------------|------------------|--------------|------------------------|
| 1401 | DuraSpec, Black | Plastic, Black | White | Silver | Black |



URBAN Public Seating - POLY SEAT & PLASTIC BACK

Four-point and Sled Base

Standard Features

- 0.875" frame
- DuraSpec Poly seat and Plastic back
- DuraSpec Poly seat available in Black or Sterling Grey
- Frame in any Spectone color
- Four-point stacks up to 8 high with dolly.
- Sled Base does not stack and ships 1 per carton
- Ships 1/carton 11 cu ft, 2-4/carton 22 cu ft

Options

- Wall-saving frame on Four-point only, add \$22 List.
- Specify back in Black RAL 9005, Light Grey RAL 7037 or White RAL 9016
- Specify back panel in Black RAL 9005, Light Grey RAL 7037 or White RAL 9016
- Polyurethane arms available in Black (B) or Sterling Grey (G)
- For Wood Back, specify and add \$94 List
- Connecting bars for a structured reconfigurable layout, add \$85 List
- Other glides may be available for an upcharge - call Customer Service to inquire



Available on Spec™ 10 Day Program



Plastic Back & Plastic Back Panel



Optional Wood Back & Plastic Back Panel



Optional Wall-saving Frame

Urban, DuraSpec Poly Seat & Plastic Back – Four-point

| MODEL | Price | | | |
|---------------------|-------|--------------|------------------------|--------------|
| 1401 | 381 | | | |
| 1411 | 381 | | | |
| Dimensions (inches) | | | | |
| seat H | 18.0 | seat W 18.0 | arm H 27.0 | total H 32.5 |
| depth | 22.0 | total W 24.0 | total W (no arms) 20.1 | |

Exceeds BIFMA Seating Durability Test to 500 lbs



1401 With arms 19 lbs



1411 Without arms 18 lbs

Urban, DuraSpec Poly Seat & Plastic Back – Sled Base

| MODEL | Price | | | |
|---------------------|-------|--------------|------------------------|--------------|
| 1431 | 484 | | | |
| 1441 | 484 | | | |
| Dimensions (inches) | | | | |
| seat H | 18.0 | seat W 18.0 | arm H 27.0 | total H 32.5 |
| depth | 22.0 | total W 24.0 | total W (no arms) 20.1 | |

Exceeds BIFMA Seating Durability Test to 500 lbs



1431 With arms 20 lbs



1441 Without arms 19 lbs

URBAN Public Seating - POLY SEAT & PLASTIC BACK

Midsize – Four-point

Standard Features

- 0.875" frame
- DuraSpec Poly seat and Plastic back
- DuraSpec Poly seat available in Black or Sterling Grey
- Frame in any Spectone color
- Four-point stacks up to 4 high with dolly.
- Sled base does not stack
- Ships 1-3/carton 21.24 cu ft

Options

- Wall-saving frame on Four-point only, add \$22 List.
- Specify back in Black RAL 9005, Light Grey RAL 7037 or White RAL 9016
- Specify back panel in Black RAL 9005, Light Grey RAL 7037 or White RAL 9016
- Polyurethane arms available in Black (B) or Sterling Grey (G)
- For Wood Back, specify and add \$94 List
- Connecting bars for a structured reconfigurable layout, add \$85 List
- Other glides may be available for an upcharge - call Customer Service to inquire



Available on Spec 10 Day Program



Plastic Back & Plastic Back Panel



Optional Wood Back & Plastic Back Panel



Optional Wall-saving Frame

Urban, DuraSpec Poly Seat & Plastic Back – Midsize – Four-point

| MODEL | Price |
|-------|-------|
| 1404 | 534 |
| 1414 | 534 |

Dimensions (inches)

| | | | | | | | |
|--------|------|---------|------|-------------------|------|---------|------|
| seat H | 18.0 | seat W | 22.0 | arm H | 27.0 | total H | 32.5 |
| depth | 22.0 | total W | 27.8 | total W (no arms) | 24.0 | | |

Exceeds BIFMA Seating Durability Test to 500 lbs



1404
With arms
22 lbs



1414
Without arms
21 lbs

Urban, DuraSpec Poly Seat & Plastic Back – Midsize – Sled Base

| MODEL | Price |
|-------|-------|
| 1434 | 636 |
| 1444 | 636 |

Dimensions (inches)

| | | | | | | | |
|--------|------|---------|------|-------------------|------|---------|------|
| seat H | 18.0 | seat W | 22.0 | arm H | 27.0 | total H | 32.5 |
| depth | 22.0 | total W | 27.8 | total W (no arms) | 24.0 | | |

Exceeds BIFMA Seating Durability Test to 500 lbs



1434
With arms
23 lbs



1444
Without arms
22 lbs



URBAN Public Seating - POLY SEAT & PLASTIC BACK

Casters

Standard Features

- 0.875" frame
- DuraSpec Poly seat and Plastic back
- DuraSpec Poly seat available in Black or Sterling Grey
- Frame in any Spectone color
- Four-point stacks up to 8 high with dolly.
- Ships 1/carton 11 cu ft, 2-4/carton 22 cu ft

Options

- Specify back in Black RAL 9005, Light Grey RAL 7037 or White RAL 9016
- Specify back panel in Black RAL 9005, Light Grey RAL 7037 or White RAL 9016
- Polyurethane arms available in Black (B) or Sterling Grey (G)
- For Wood Back, specify and add \$94 List
- Armless and sled base versions not available



Plastic Back & Plastic Back Panel



Optional Wood Back & Plastic Back Panel

Urban, DuraSpec Poly Seat & Plastic Back – Casters

MODEL Price
1402 523

Dimensions (inches)

| | | | | | |
|---------|------|---------|------|-------|------|
| seat H | 18.0 | seat W | 18.0 | arm H | 27.0 |
| total H | 32.5 | total W | 24.0 | depth | 22.0 |

Exceeds BIFMA Seating Durability Test to 500 lbs



1402
With arms
 19 lbs

URBAN Public Seating - POLY SEAT & PLASTIC BACK

Stools

Standard Features

- 0.875" frame
- DuraSpec Poly seat and Plastic back
- DuraSpec Poly seat available in Black or Sterling Grey
- Frame in any Spectone color
- Ships 1/carton 17 cu ft

Options

- Specify back in Black RAL 9005, Light Grey RAL 7037 or White RAL 9016
- Specify back panel in Black RAL 9005, Light Grey RAL 7037 or White RAL 9016
- Polyurethane arms available in Black (B) or Sterling Grey (G)
- For Wood Back, specify and add \$94 List
- Casters, sled base not available
- Other glides may be available for an upcharge - call Customer Service to inquire



Plastic Back & Plastic Back Panel



Optional Wood Back & Plastic Back Panel

Urban, DuraSpec Poly Seat & Plastic Back – Stools

| MODEL | Price |
|-------|-------|
| 1421 | 511 |
| 1425 | 511 |

Dimensions (inches)

| | | | | | | | |
|--------|------|---------|------|-------------------|------|---------|------|
| seat H | 28.0 | seat W | 18.0 | arm H | 37.0 | total H | 43.5 |
| depth | 22.0 | total W | 24.0 | total W (no arms) | 20.1 | | |

Exceeds BIFMA Seating Durability Test to 500 lbs



1421
With arms
25 lbs



1425
Without arms
24 lbs

Urban, DuraSpec Poly Seat & Plastic Back – Midsize Stools

| MODEL | Price |
|-------|-------|
| 1424 | 665 |
| 1426 | 665 |

Dimensions (inches)

| | | | | | | | |
|--------|------|---------|------|-------------------|------|---------|------|
| seat H | 28.0 | seat W | 22.0 | arm H | 37.0 | total H | 43.5 |
| depth | 22.0 | total W | 27.8 | total W (no arms) | 24.0 | | |

Exceeds BIFMA Seating Durability Test to 500 lbs



1424
With arms
27 lbs



1426
Without arms
26 lbs

URBAN Public Seating - POLY SEAT & PLASTIC BACK

Easy Access Hip Single Seater

Standard Features

- 0.875" frame
- DuraSpec Poly seat and Plastic back
- DuraSpec Poly seat available in Black or Sterling Grey
- Frame in any Spectone color
- Ships 1/carton 19 cu ft

Options

- Specify back in Black RAL 9005, Light Grey RAL 7037 or White RAL 9016
- Specify back panel in Black RAL 9005, Light Grey RAL 7037 or White RAL 9016
- Polyurethane arms available in Black (B) or Sterling Grey (G)
- For Wood Back, specify and add \$94 List
- Casters, sled base not available
- Other glides may be available for an upcharge - call Customer Service to inquire



Plastic Back & Plastic Back Panel



Optional Wood Back & Plastic Back Panel

Urban, DuraSpec Poly Seat & Plastic Back – Easy Access Hip Single Seater

MODEL Price
1421E 556

Dimensions (inches)
 seat H 24.0 seat W 18.0 arm H 33.0
 total H 38.5 total W 24.0 depth 32.0

Exceeds BIFMA Seating Durability Test to 500 lbs



1421E
 With arms
 31 lbs

Urban, DuraSpec Poly Seat & Plastic Back – Midsize Easy Access Hip Single Seater

MODEL Price
1424E 709

Dimensions (inches)
 seat H 24.0 seat W 22.0 arm H 33.0
 total H 38.5 total W 27.8 depth 32.0

Exceeds BIFMA Seating Durability Test to 500 lbs



1424E
 With arms
 33 lbs



URBAN Public Seating - POLY SEAT & UPHOLSTERED BACK

HOW TO ORDER



Specify Model

- A** Specify Seat Type and Color
For DuraSpec Seat: Color
- B** Specify Back Type and Color
For Upholstered Back: Fabric Manufacturer, Pattern Name, Color
- C** Specify Back Panel Color
- D** Specify Frame Finish
- E** Specify Polyurethane Arm Color

Optional: CAL 133, Moisture Barrier, Wall-saving Frame, Connecting Bars, Connecting Tables, Dolly

| Model | Seat Type and Color | Back Type and Color | Back Panel Color | Frame Finish | Polyurethane Arm Color |
|---------|-------------------------|---------------------------|-------------------|--------------|------------------------|
| 1401-UB | DuraSpec, Sterling Grey | Momentum, Beeline, Canvas | White (not shown) | Silver | Sterling Grey |



URBAN Public Seating - POLY SEAT & UPHOLSTERED BACK

Four-point and Sled Base

Standard Features

- 0.875" frame
- DuraSpec Poly seat and Upholstered back
- DuraSpec Poly seat available in Black or Sterling Grey
- Frame in any Spectone color
- Four-point stacks up to 8 high with dolly.
- Sled Base does not stack and ships 1 per carton
- Ships 1/carton 11 cu ft, 2-4/carton 22 cu ft

Contact Spec Customer Service to railroad fabrics (specify repeat info and yardage requirement will be provided) and for repeats greater than 5" x 5"

Options

- Wall-saving frame on Four-point only, add \$22 List,
- Specify back panel in Black RAL 9005, Light Grey RAL 7037 or White RAL 9016
- Polyurethane arms available in Black (B) or Sterling Grey (G)
- Connecting bars for a structured reconfigurable layout, add \$85 List
- Antibacterial and antimicrobial fabrics available
- Other glides may be available for an upcharge - call Customer Service to inquire



Urban, DuraSpec Poly Seat & Upholstered Back – Four-point

COM 0.5 yd
0.5 yd COM per single back

| MODEL | COM | GR 1 | GR 2 | GR 3 | GR 4 | GR 5 | GR 6 |
|----------------|------------|------------|------------|------------|------------|------------|------------|
| 1401-UB | 394 | 424 | 434 | 453 | 484 | 504 | 536 |
| 1411-UB | 394 | 424 | 434 | 453 | 484 | 504 | 536 |

Dimensions (inches)

| | seat H | 18.0 | seat W | 18.0 | arm H | 27.0 | total H | 32.5 |
|-------|--------|---------|--------|-------------------|-------|------|---------|------|
| depth | 22.0 | total W | 24.0 | total W (no arms) | 20.1 | | | |

Exceeds BIFMA Seating Durability Test to 500 lbs



Urban, DuraSpec Poly Seat & Upholstered Back – Sled Base

COM 0.5 yd
0.5 yd COM per single back

| MODEL | COM | GR 1 | GR 2 | GR 3 | GR 4 | GR 5 | GR 6 |
|----------------|------------|------------|------------|------------|------------|------------|------------|
| 1431-UB | 497 | 527 | 537 | 556 | 586 | 607 | 639 |
| 1441-UB | 497 | 527 | 537 | 556 | 586 | 607 | 639 |

Dimensions (inches)

| | seat H | 18.0 | seat W | 18.0 | arm H | 27.0 | total H | 32.5 |
|-------|--------|---------|--------|-------------------|-------|------|---------|------|
| depth | 22.0 | total W | 24.0 | total W (no arms) | 20.1 | | | |

Exceeds BIFMA Seating Durability Test to 500 lb



URBAN Public Seating - POLY SEAT & UPHOLSTERED BACK

Midsize – Four-point and Sled Base

Standard Features

- 0.875" frame
- DuraSpec Poly seat and Upholstered back
- DuraSpec Poly seat available in Black or Sterling Grey
- Frame in any Spectone color
- Four-point stacks up to 4 high with dolly.
- Sled Base does not stack and ships 1 per carton
- Ships 1-3/carton 21.24 cu ft

Contact Spec Customer Service to railroad fabrics (specify repeat info and yardage requirement will be provided) and for repeats greater than 5" x 5"

Options

- Wall-saving frame on Four-point only, add \$22 List.
- Specify back panel in Black RAL 9005, Light Grey RAL 7037 or White RAL 9016
- Polyurethane arms available in Black (B) or Sterling Grey (G)
- Connecting bars for a structured reconfigurable layout, add \$85 List
- Antibacterial and antimicrobial fabrics available
- Other glides may be available for an upcharge - call Customer Service to inquire



Urban, DuraSpec Poly Seat & Upholstered Back – Midsize – Four-point

COM 0.75 yd
0.75 yd COM per single back

| MODEL | COM | GR 1 | GR 2 | GR 3 | GR 4 | GR 5 | GR 6 |
|----------------|------------|------------|------------|------------|------------|------------|------------|
| 1404-UB | 556 | 614 | 633 | 673 | 731 | 777 | 836 |
| 1414-UB | 556 | 614 | 633 | 673 | 731 | 777 | 836 |

Dimensions (inches)

| | seat H | 18.0 | seat W | 22.0 | arm H | 27.0 | total H | 32.5 |
|-------|--------|---------|--------|-------------------|-------|------|---------|------|
| depth | 22.0 | total W | 27.8 | total W (no arms) | 24.0 | | | |

Exceeds BIFMA Seating Durability Test to 500 lbs



Urban, DuraSpec Poly Seat & Upholstered Back – Midsize – Sled Base

COM 0.75 yd
0.75 yd COM per single back

| MODEL | COM | GR 1 | GR 2 | GR 3 | GR 4 | GR 5 | GR 6 |
|----------------|------------|------------|------------|------------|------------|------------|------------|
| 1434-UB | 658 | 717 | 736 | 776 | 834 | 880 | 939 |
| 1444-UB | 658 | 717 | 736 | 776 | 834 | 880 | 939 |

Dimensions (inches)

| | seat H | 18.0 | seat W | 22.0 | arm H | 27.0 | total H | 32.5 |
|-------|--------|---------|--------|-------------------|-------|------|---------|------|
| depth | 22.0 | total W | 27.8 | total W (no arms) | 24.0 | | | |

Exceeds BIFMA Seating Durability Test to 500 lbs





URBAN Public Seating - POLY SEAT & UPHOLSTERED BACK

Casters

Standard Features

- 0.875" frame
- DuraSpec Poly seat and Upholstered back
- DuraSpec Poly seat available in Black or Sterling Grey
- Frame in any Spectone color
- Four-point stacks up to 8 high with dolly.
- Ships 1/carton 11 cu ft, 2-4/carton 22 cu ft

Options

- Specify back panel in Black RAL 9005, Light Grey RAL 7037 or White RAL 9016
- Polyurethane arms available in Black (B) or Sterling Grey (G)
- Antibacterial and antimicrobial fabrics available
- Armless and sled base versions not available

Contact Spec Customer Service to railroad fabrics (specify repeat info and yardage requirement will be provided) and for repeats greater than 5" x 5"



Upholstered Back & Plastic Back Panel

Urban, DuraSpec Poly Seat & Upholstered Back – Casters

COM 0.5 yd
0.5 yd COM per single back

| MODEL | COM | GR1 | GR2 | GR3 | GR4 | GR5 | GR6 |
|----------------|------------|------------|------------|------------|------------|------------|------------|
| 1402-UB | 537 | 566 | 576 | 596 | 624 | 647 | 677 |

Dimensions (inches)

| | | | | | |
|---------|------|---------|------|-------|------|
| seat H | 18.0 | seat W | 18.0 | arm H | 27.0 |
| total H | 32.5 | total W | 24.0 | depth | 22.0 |

Exceeds BIFMA Seating Durability Test to 500 lbs



1402-UB
With arms
19 lbs

URBAN Public Seating - POLY SEAT & UPHOLSTERED BACK

Stools

Standard Features

- 0.875" frame
- DuraSpec Poly seat and Upholstered back
- DuraSpec Poly seat available in Black or Sterling Grey
- Frame in any Spectone color
- Ships 1/carton 17 cu ft

Contact Spec Customer Service to railroad fabrics (specify repeat info and yardage requirement will be provided) and for repeats greater than 5" x 5"

Options

- Specify back panel in Black RAL 9005, Light Grey RAL 7037 or White RAL 9016
- Polyurethane arms available in Black (B) or Sterling Grey (G)
- Antibacterial and antimicrobial fabrics available
- Casters, sled base not available
- Other glides may be available for an upcharge - call Customer Service to inquire



Upholstered Back & Plastic Back Panel

Urban, DuraSpec Poly Seat & Upholstered Back – Stools

COM 0.5 yd
0.5 yd COM per single back

| MODEL | COM | GR1 | GR2 | GR3 | GR4 | GR5 | GR6 |
|----------------|------------|------------|------------|------------|------------|------------|------------|
| 1421-UB | 526 | 555 | 565 | 584 | 614 | 636 | 667 |
| 1425-UB | 526 | 555 | 565 | 584 | 614 | 636 | 667 |

Dimensions (inches)

| | | | | | | | |
|--------|------|---------|------|-------------------|------|---------|------|
| seat H | 28.0 | seat W | 18.0 | arm H | 37.0 | total H | 43.5 |
| depth | 22.0 | total W | 24.0 | total W (no arms) | 20.1 | | |

Exceeds BIFMA Seating Durability Test to 500 lbs



1421-UB
With arms
25 lbs



1425-UB
Without arms
24 lbs

Urban, DuraSpec Poly Seat & Upholstered Back – Midsize Stools

COM 0.75 yd
0.75 yd COM per single back

| MODEL | COM | GR1 | GR2 | GR3 | GR4 | GR5 | GR6 |
|----------------|------------|------------|------------|------------|------------|------------|------------|
| 1424-UB | 686 | 745 | 763 | 804 | 862 | 907 | 967 |
| 1426-UB | 686 | 745 | 763 | 804 | 862 | 907 | 967 |

Dimensions (inches)

| | | | | | | | |
|--------|------|---------|------|-------------------|------|---------|------|
| seat H | 28.0 | seat W | 22.0 | arm H | 37.0 | total H | 43.5 |
| depth | 22.0 | total W | 27.8 | total W (no arms) | 24.0 | | |

Exceeds BIFMA Seating Durability Test to 500 lbs



1424-UB
With arms
27 lbs



1426-UB
Without arms
26 lbs



URBAN Public Seating - POLY SEAT & UPHOLSTERED BACK

Easy Access Hip Single Seater

Standard Features

- 0.875" frame
- DuraSpec Poly seat and Upholstered back
- DuraSpec Poly seat available in Black or Sterling Grey
- Frame in any Spectone color
- Ships 1/carton 19 cu ft

Contact Spec Customer Service to railroad fabrics (specify repeat info and yardage requirement will be provided) and for repeats greater than 5" x 5"

Options

- Specify back panel in Black RAL 9005, Light Grey RAL 7037 or White RAL 9016
- Polyurethane arms available in Black (B) or Sterling Grey (G)
- Antibacterial and antimicrobial fabrics available
- Casters, sled base not available
- Other glides may be available for an upcharge - call Customer Service to inquire



Upholstered Back & Plastic Back Panel

Urban, DuraSpec Poly Seat & Upholstered Back – Easy Access Hip Single Seater

COM 0.5 yd
0.5 yd COM per single back

| MODEL | COM | GR1 | GR2 | GR3 | GR4 | GR5 | GR6 |
|-----------------|------------|------------|------------|------------|------------|------------|------------|
| 1421E-UB | 570 | 600 | 609 | 630 | 658 | 680 | 711 |

Dimensions (inches)

| | | | | | |
|---------|------|---------|------|-------|------|
| seat H | 24.0 | seat W | 18.0 | arm H | 33.0 |
| total H | 38.5 | total W | 24.0 | depth | 32.0 |

Exceeds BIFMA Seating Durability Test to 500 lbs



1421E-UB
With arms
31 lbs

Urban, DuraSpec Poly Seat & Upholstered Back – Midsize Easy Access Hip Single Seater

COM 0.75 yd
0.75 yd COM per single back

| MODEL | COM | GR1 | GR2 | GR3 | GR4 | GR5 | GR6 |
|-----------------|------------|------------|------------|------------|------------|------------|-------------|
| 1424E-UB | 731 | 789 | 809 | 849 | 907 | 953 | 1012 |

Dimensions (inches)

| | | | | | |
|---------|------|---------|------|-------|------|
| seat H | 24.0 | seat W | 22.0 | arm H | 33.0 |
| total H | 38.5 | total W | 27.8 | depth | 32.0 |

Exceeds BIFMA Seating Durability Test to 500 lbs



1424E-UB
With arms
33 lbs



URBAN Public Seating - UPHOLSTERED SEAT & PLASTIC BACK

BACK TO CONTENTS

HOW TO ORDER

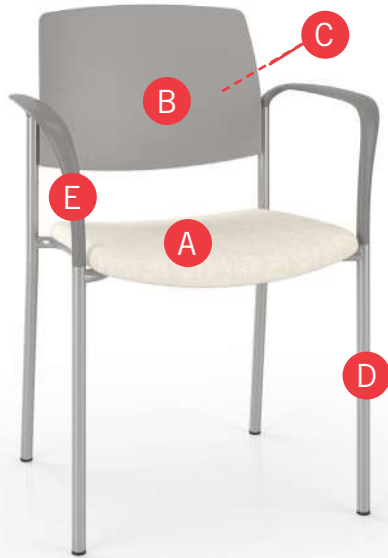

Specify Model

- A** Specify Seat Type and Color
For Upholstered Seat: Fabric Manufacturer, Pattern Name, Color
- B** Specify Back Type and Color
For Plastic Back: Color
For Wood Back: Wood Stain
- C** Specify Back Panel Color
- D** Specify Frame Finish
- E** Specify Polyurethane Arm Color

Optional: Wood Back, Custom Wood Back Design, Moisture Barrier, Wall-saving Frame, Connecting Bars, Connecting Tables, Dolly

| Model | Seat Type and Color | Back Type and Color | Back Panel Color | Frame Finish | Polyurethane Arm Color |
|---------|---------------------------|---------------------|-------------------|--------------|------------------------|
| 1401-US | Momentum, Beeline, Canvas | Plastic, Light Grey | White (not shown) | Silver | Sterling Grey |



URBAN Public Seating - UPHOLSTERED SEAT & PLASTIC BACK

Four-point and Sled Base

Standard Features

- 0.875" frame
- Upholstered seat and plastic back
- Frame in any Spectone color
- Four-point stacks up to 8 high with dolly.
- Sled Base does not stack and ships 1 per carton
- Ships 1/carton 11 cu ft, 2-4/carton 22 cu ft

Contact Spec Customer Service to railroad fabrics (specify repeat info and yardage requirement will be provided) and for repeats greater than 5" x 5"

Options

- Wall-saving frame on Four-point only, add \$22 List
- Specify back in Black RAL 9005, Light Grey RAL 7037 or White RAL 9016
- Specify back panel in Black RAL 9005, Light Grey RAL 7037 or White RAL 9016
- Polyurethane arms available in Black (B) or Sterling Grey (G)
- For Wood Back, specify and add \$94 List
- Connecting bars for a structured reconfigurable layout, add \$85 List
- Antibacterial and antimicrobial fabrics available
- Other glides may be available for an upcharge - call Customer Service to inquire



Urban, Upholstered Seat & Plastic Back – Four-point

COM 0.5 yd
0.5 yd COM per single seat

| MODEL | COM | GR1 | GR2 | GR3 | GR4 | GR5 | GR6 |
|---------|-----|-----|-----|-----|-----|-----|-----|
| 1401-US | 407 | 437 | 447 | 467 | 496 | 517 | 548 |
| 1411-US | 407 | 437 | 447 | 467 | 496 | 517 | 548 |

Dimensions (inches)

| | seat H | 18.0 | seat W | 18.0 | arm H | 27.0 | total H | 32.5 |
|-------|--------|---------|--------|-------------------|-------|------|---------|------|
| depth | 22.0 | total W | 24.0 | total W (no arms) | 20.1 | | | |

Exceeds BIFMA Seating Durability Test to 500 lbs
1" extra seat foam, specify and add \$15 List



Urban, Upholstered Seat & Plastic Back – Sled Base

COM 0.5 yd
0.5 yd COM per single seat

| MODEL | COM | GR1 | GR2 | GR3 | GR4 | GR5 | GR6 |
|---------|-----|-----|-----|-----|-----|-----|-----|
| 1431-US | 510 | 540 | 549 | 569 | 599 | 620 | 651 |
| 1441-US | 510 | 540 | 549 | 569 | 599 | 620 | 651 |

Dimensions (inches)

| | seat H | 18.0 | seat W | 18.0 | arm H | 27.0 | total H | 32.5 |
|-------|--------|---------|--------|-------------------|-------|------|---------|------|
| depth | 22.0 | total W | 24.0 | total W (no arms) | 20.1 | | | |

Exceeds BIFMA Seating Durability Test to 500 lb
1" extra seat foam, specify and add \$15 List





URBAN Public Seating - UPHOLSTERED SEAT & PLASTIC BACK

Midsize – Four-point and Sled Base

Standard Features

- 0.875" frame
- Upholstered seat and plastic back
- Frame in any Spectone color
- Four-point stacks up to 4 high with dolly.
- Sled Base does not stack and ships 1 per carton
- Ships 1-3/carton 21.24 cu ft

Contact Spec Customer Service to railroad fabrics (specify repeat info and yardage requirement will be provided) and for repeats greater than 5" x 5"

Options

- Wall-saving frame on Four-point only, add \$22 List
- Specify back in Black RAL 9005, Light Grey RAL 7037 or White RAL 9016
- Specify back panel in Black RAL 9005, Light Grey RAL 7037 or White RAL 9016
- Polyurethane arms available in Black (B) or Sterling Grey (G)
- For Wood Back, specify and add \$94 List
- Connecting bars for a structured reconfigurable layout, add \$85 List
- Antibacterial and antimicrobial fabrics available
- Other glides may be available for an upcharge - call Customer Service to inquire



Urban, Upholstered Seat & Plastic Back – Midsize – Four-point

COM 0.75 yd
0.75 yd COM per single seat

| MODEL | COM | GR1 | GR2 | GR3 | GR4 | GR5 | GR6 |
|---------|-----|-----|-----|-----|-----|-----|-----|
| 1404-US | 516 | 563 | 578 | 609 | 656 | 693 | 742 |
| 1414-US | 516 | 563 | 578 | 609 | 656 | 693 | 742 |

Dimensions (inches)

| | seat H | 18.0 | seat W | 22.0 | arm H | 27.0 | total H | 32.5 |
|-------|--------|---------|--------|-------------------|-------|------|---------|------|
| depth | 22.0 | total W | 27.8 | total W (no arms) | 24.0 | | | |

Exceeds BIFMA Seating Durability Test to 500 lbs
1" extra seat foam, specify and add \$23 List



Urban, Upholstered Seat & Plastic Back – Midsize – Sled Base

COM 0.75 yd
0.75 yd COM per single seat

| MODEL | COM | GR1 | GR2 | GR3 | GR4 | GR5 | GR6 |
|---------|-----|-----|-----|-----|-----|-----|-----|
| 1434-US | 619 | 666 | 681 | 712 | 759 | 796 | 844 |
| 1444-US | 619 | 666 | 681 | 712 | 759 | 796 | 844 |

Dimensions (inches)

| | seat H | 18.0 | seat W | 22.0 | arm H | 27.0 | total H | 32.5 |
|-------|--------|---------|--------|-------------------|-------|------|---------|------|
| depth | 22.0 | total W | 27.8 | total W (no arms) | 24.0 | | | |

Exceeds BIFMA Seating Durability Test to 500 lbs
1" extra seat foam, specify and add \$23 List





URBAN Public Seating - UPHOLSTERED SEAT & PLASTIC BACK

Casters

Standard Features

- 0.875" frame
- Upholstered seat and plastic back
- Frame in any Spectone color
- Four-point stacks up to 8 high with dolly.
- Ships 1/carton 11 cu ft, 2-4/carton 22 cu ft

Contact Spec Customer Service to railroad fabrics (specify repeat info and yardage requirement will be provided) and for repeats greater than 5" x 5"

Options

- Specify back in Black RAL 9005, Light Grey RAL 7037 or White RAL 9016
- Specify back panel in Black RAL 9005, Light Grey RAL 7037 or White RAL 9016
- Polyurethane arms available in Black (B) or Sterling Grey (G)
- For Wood Back, specify and add \$94 List
- Antibacterial and antimicrobial fabrics available
- Armless and sled base versions not available



Plastic Back & Plastic Back Panel



Optional Wood Back & Plastic Back Panel

Urban, Upholstered Seat & Plastic Back – Casters

COM 0.5 yd
0.5 yd COM per single seat

| MODEL | COM | GR1 | GR2 | GR3 | GR4 | GR5 | GR6 |
|----------------|------------|------------|------------|------------|------------|------------|------------|
| 1402-US | 549 | 579 | 590 | 608 | 639 | 659 | 691 |

Dimensions (inches)

| | | | | | |
|---------|------|---------|------|-------|------|
| seat H | 18.0 | seat W | 18.0 | arm H | 27.0 |
| total H | 32.5 | total W | 24.0 | depth | 22.0 |

Exceeds BIFMA Seating Durability Test to 500 lbs
1" extra seat foam, specify and add \$15 List



1402-US
With arms
19 lbs



URBAN Public Seating - UPHOLSTERED SEAT & PLASTIC BACK

Stools

Standard Features

- 0.875" frame
- Upholstered seat and plastic back
- Frame in any Spectone color
- Ships 1/carton 17 cu ft

Contact Spec Customer Service to railroad fabrics (specify repeat info and yardage requirement will be provided) and for repeats greater than 5" x 5"

Options

- Specify back in Black RAL 9005, Light Grey RAL 7037 or White RAL 9016
- Specify back panel in Black RAL 9005, Light Grey RAL 7037 or White RAL 9016
- Polyurethane arms available in Black (B) or Sterling Grey (G)
- For Wood Back, specify and add \$94 List
- Antibacterial and antimicrobial fabrics available
- Casters, sled base not available
- Other glides may be available for an upcharge - call Customer Service to inquire



Plastic Back & Plastic Back Panel



Optional Wood Back & Plastic Back Panel

Urban, Upholstered Seat & Plastic Back – Stools

COM 0.5 yd
0.5 yd COM per single seat

| MODEL | COM | GR1 | GR2 | GR3 | GR4 | GR5 | GR6 |
|---------|-----|-----|-----|-----|-----|-----|-----|
| 1421-US | 539 | 568 | 578 | 598 | 627 | 649 | 679 |
| 1425-US | 539 | 568 | 578 | 598 | 627 | 649 | 679 |

Dimensions (inches)

| | | | | | | | |
|--------|------|---------|------|-------------------|------|---------|------|
| seat H | 28.0 | seat W | 18.0 | arm H | 37.0 | total H | 43.5 |
| depth | 22.0 | total W | 24.0 | total W (no arms) | 20.1 | | |

Exceeds BIFMA Seating Durability Test to 500 lbs
1" extra seat foam, specify and add \$15 List



1421-US
With arms
25 lbs



1425-US
Without arms
24 lbs

Urban, Upholstered Seat & Plastic Back – Midsize Stools

COM 0.75 yd
0.75 yd COM per single seat

| MODEL | COM | GR1 | GR2 | GR3 | GR4 | GR5 | GR6 |
|---------|-----|-----|-----|-----|-----|-----|-----|
| 1424-US | 647 | 693 | 709 | 740 | 787 | 824 | 872 |
| 1426-US | 647 | 693 | 709 | 740 | 787 | 824 | 872 |

Dimensions (inches)

| | | | | | | | |
|--------|------|---------|------|-------------------|------|---------|------|
| seat H | 28.0 | seat W | 22.0 | arm H | 37.0 | total H | 43.5 |
| depth | 22.0 | total W | 27.8 | total W (no arms) | 24.0 | | |

Exceeds BIFMA Seating Durability Test to 500 lbs
1" extra seat foam, specify and add \$23 List



1424-US
With arms
27 lbs



1426-US
Without arms
26 lbs



URBAN Public Seating - UPHOLSTERED SEAT & PLASTIC BACK

Easy Access Hip Single Seater

Standard Features

- 0.875" frame
- Upholstered seat and plastic back
- Frame in any Spectone color
- Ships 1/carton 19 cu ft

Contact Spec Customer Service to railroad fabrics (specify repeat info and yardage requirement will be provided) and for repeats greater than 5" x 5"

Options

- Specify back in Black RAL 9005, Light Grey RAL 7037 or White RAL 9016
- Specify back panel in Black RAL 9005, Light Grey RAL 7037 or White RAL 9016
- Polyurethane arms available in Black (B) or Sterling Grey (G)
- For Wood Back, specify and add \$94 List
- Antibacterial and antimicrobial fabrics available
- Casters, sled base not available
- Other glides may be available for an upcharge - call Customer Service to inquire



Plastic Back & Plastic Back Panel



Optional Wood Back & Plastic Back Panel

Urban, Upholstered Seat & Plastic Back – Easy Access Hip Single Seater

COM 0.5 yd
0.5 yd COM per single seat

| MODEL | COM | GR1 | GR2 | GR3 | GR4 | GR5 | GR6 |
|-----------------|------------|------------|------------|------------|------------|------------|------------|
| 1421E-US | 583 | 613 | 622 | 643 | 672 | 694 | 724 |

Dimensions (inches)

| | | | | | |
|---------|------|---------|------|-------|------|
| seat H | 24.0 | seat W | 18.0 | arm H | 33.0 |
| total H | 38.5 | total W | 24.0 | depth | 32.0 |

Exceeds BIFMA Seating Durability Test to 500 lbs
1" extra seat foam, specify and add \$15 List



1421E-US
With arms
31 lbs

Urban, Upholstered Seat & Plastic Back – Midsize Easy Access Hip Single Seater

COM 0.75 yd
0.75 yd COM per single seat

| MODEL | COM | GR1 | GR2 | GR3 | GR4 | GR5 | GR6 |
|-----------------|------------|------------|------------|------------|------------|------------|------------|
| 1424E-US | 692 | 738 | 754 | 785 | 832 | 868 | 917 |

Dimensions (inches)

| | | | | | |
|---------|------|---------|------|-------|------|
| seat H | 24.0 | seat W | 22.0 | arm H | 33.0 |
| total H | 38.5 | total W | 27.8 | depth | 32.0 |

Exceeds BIFMA Seating Durability Test to 500 lbs
1" extra seat foam, specify and add \$23 List



1424E-US
With arms
33 lbs



URBAN Public Seating - UPHOLSTERED SEAT & BACK

BACK TO CONTENTS

HOW TO ORDER



Specify Model

- A** Specify Seat Type and Color
For Upholstered Seat: Fabric Manufacturer, Pattern Name, Color
- B** Specify Back Type and Color
For Upholstered Back: Fabric Manufacturer, Pattern Name, Color
- C** Specify Back Panel Color
- D** Specify Frame Finish
- E** Specify Polyurethane Arm Color

Optional: CAL 133, Moisture Barrier, Wall-saving Frame, Connecting Bars, Connecting Tables, Dolly

| Model | Seat Type and Color | Back Type and Color | Back Panel Color | Frame Finish | Polyurethane Arm Color |
|---------|---------------------------|---------------------------|-------------------|--------------|------------------------|
| 1401-UP | Momentum, Beeline, Canvas | Momentum, Beeline, Canvas | White (not shown) | Silver | Sterling Grey |



URBAN Public Seating - UPHOLSTERED SEAT & BACK

Four-point and Sled Base

Standard Features

- 0.875" frame
- Seat and back upholstered
- Frame in any Spectone color
- Four-point stacks up to 8 high with dolly.
- Sled Base does not stack and ships 1 per carton
- Ships 1/carton 11 cu ft, 2-4/carton 22 cu ft

Contact Spec Customer Service to railroad fabrics (specify repeat info and yardage requirement will be provided) and for repeats greater than 5" x 5"

Options

- Wall-saving frame on Four-point only, add \$22 List,
- Specify back panel in Black RAL 9005, Light Grey RAL 7037 or White RAL 9016
- Polyurethane arms available in Black (B) or Sterling Grey (G)
- Connecting bars for a structured reconfigurable layout, add \$85 List
- Antibacterial and antimicrobial fabrics available
- Different fabric on seat and back at no upcharge
- CAL 133
- Other glides may be available for an upcharge - call Customer Service to inquire



Upholstered Back & Plastic Back Panel



Optional Wall-saving Frame

Urban, Upholstered Seat & Back – Four-point

COM 1.0 yd
0.5 yd COM per single seat
0.5 yd COM per single back

| MODEL | COM | GR1 | GR2 | GR3 | GR4 | GR5 | GR6 |
|----------------|------------|------------|------------|------------|------------|------------|------------|
| 1401-UP | 422 | 479 | 499 | 539 | 598 | 643 | 703 |
| 1411-UP | 422 | 479 | 499 | 539 | 598 | 643 | 703 |

Dimensions (inches)

| | seat H | 18.0 | seat W | 18.0 | arm H | 27.0 | total H | 32.5 |
|-------|--------|---------|--------|-------------------|-------|------|---------|------|
| depth | 22.0 | total W | 24.0 | total W (no arms) | 20.1 | | | |

Exceeds BIFMA Seating Durability Test to 500 lbs
CAL 133, add \$62 List
1" extra seat foam, specify and add \$15 List



1401-UP
With arms
19 lbs



1411-UP
Without arms
18 lbs

Urban, Upholstered Seat & Back – Sled Base

COM 1.0 yd
0.5 yd COM per single seat
0.5 yd COM per single back

| MODEL | COM | GR1 | GR2 | GR3 | GR4 | GR5 | GR6 |
|----------------|------------|------------|------------|------------|------------|------------|------------|
| 1431-UP | 525 | 582 | 602 | 642 | 701 | 746 | 806 |
| 1441-UP | 525 | 582 | 602 | 642 | 701 | 746 | 806 |

Dimensions (inches)

| | seat H | 18.0 | seat W | 18.0 | arm H | 27.0 | total H | 32.5 |
|-------|--------|---------|--------|-------------------|-------|------|---------|------|
| depth | 22.0 | total W | 24.0 | total W (no arms) | 20.1 | | | |

Exceeds BIFMA Seating Durability Test to 500 lbs
CAL 133, add \$62 List
1" extra seat foam, specify and add \$15 List



1431-UP
With arms
20 lbs



1441-UP
Without arms
19 lbs

URBAN Public Seating - UPHOLSTERED SEAT & BACK

MidSize – Four-point and Sled Base

Standard Features

- 0.875" frame
- Seat and back upholstered
- Frame in any Spectone color
- Four-point stacks up to 4 high with dolly.
- Sled Base does not stack and ships 1 per carton
- Ships 1-3/carton 21.24 cu ft

Contact Spec Customer Service to railroad fabrics (specify repeat info and yardage requirement will be provided) and for repeats greater than 5" x 5"

Options

- Wall-saving frame on Four-point only, add \$22 List.
- Specify back panel in Black RAL 9005, Light Grey RAL 7037 or White RAL 9016
- Polyurethane arms available in Black (B) or Sterling Grey (G)
- Connecting bars for a structured reconfigurable layout, add \$85 List
- Antibacterial and antimicrobial fabrics available
- Different fabric on seat and back at no upcharge
- CAL 133
- Other glides may be available for an upcharge - call Customer Service to inquire



Urban, Upholstered Seat & Back – Midsize – Four-point

COM 1.5 yd
0.75 yd COM per single seat
0.75 yd COM per single back

| MODEL | COM | GR1 | GR2 | GR3 | GR4 | GR5 | GR6 |
|---------|-----|-----|-----|-----|-----|-----|------|
| 1404-UP | 537 | 641 | 676 | 747 | 853 | 934 | 1042 |
| 1414-UP | 537 | 641 | 676 | 747 | 853 | 934 | 1042 |

Dimensions (inches)

| | seat H | 18.0 | seat W | 22.0 | arm H | 27.0 | total H | 32.5 |
|-------|--------|---------|--------|-------------------|-------|------|---------|------|
| depth | 22.0 | total W | 27.8 | total W (no arms) | 24.0 | | | |

Exceeds BIFMA Seating Durability Test to 500 lbs
CAL 133, add \$87 List
1" extra seat foam, specify and add \$23 List



Urban, Upholstered Seat & Back – Midsize – Sled Base

COM 1.5 yd
0.75 yd COM per single seat
0.75 yd COM per single back

| MODEL | COM | GR1 | GR2 | GR3 | GR4 | GR5 | GR6 |
|---------|-----|-----|-----|-----|-----|------|------|
| 1434-UP | 640 | 744 | 779 | 850 | 956 | 1037 | 1145 |
| 1444-UP | 640 | 744 | 779 | 850 | 956 | 1037 | 1145 |

Dimensions (inches)

| | seat H | 18.0 | seat W | 22.0 | arm H | 27.0 | total H | 32.5 |
|-------|--------|---------|--------|-------------------|-------|------|---------|------|
| depth | 22.0 | total W | 27.8 | total W (no arms) | 24.0 | | | |

Exceeds BIFMA Seating Durability Test to 500 lbs
CAL 133, add \$87 List
1" extra seat foam, specify and add \$23 List





URBAN Public Seating - UPHOLSTERED SEAT & BACK

Casters

Standard Features

- 0.875" frame
- Upholstered seat and back
- Frame in any Spectone color
- Four-point stacks up to 8 high with dolly.
- Ships 1/carton 11 cu ft, 2-4/carton 22 cu ft

Contact Spec Customer Service to railroad fabrics (specify repeat info and yardage requirement will be provided) and for repeats greater than 5" x 5"

Options

- Specify back panel in Black RAL 9005, Light Grey RAL 7037 or White RAL 9016
- Polyurethane arms available in Black (B) or Sterling Grey (G)
- Antibacterial and antimicrobial fabrics available
- Different fabric on seat and back at no upcharge
- Armless and sled base versions not available
- CAL 133



Upholstered Back & Plastic Back Panel

Urban, Upholstered Seat & Back – Casters

COM 1.0 yd
0.5 yd COM per single seat
0.5 yd COM per single back

| MODEL | COM | GR1 | GR2 | GR3 | GR4 | GR5 | GR6 |
|----------------|------------|------------|------------|------------|------------|------------|------------|
| 1402-UP | 564 | 621 | 642 | 680 | 740 | 784 | 844 |

Dimensions (inches)

| | | | | | |
|---------|------|---------|------|-------|------|
| seat H | 18.0 | seat W | 18.0 | arm H | 27.0 |
| total H | 32.5 | total W | 24.0 | depth | 22.0 |

Exceeds BIFMA Seating Durability Test to 500 lbs
CAL 133, add \$62 List
1" extra seat foam, specify and add \$15 List



1402-UP
With arms
19 lbs



URBAN Public Seating - UPHOLSTERED SEAT & BACK

Stools

Standard Features

- 0.875" frame
- Upholstered seat and back
- Frame in any Spectone color
- Ships 1/carton 17 cu ft

Contact Spec Customer Service to railroad fabrics (specify repeat info and yardage requirement will be provided) and for repeats greater than 5" x 5"

Options

- Specify back panel in Black RAL 9005, Light Grey RAL 7037 or White RAL 9016
- Polyurethane arms available in Black (B) or Sterling Grey (G)
- Antibacterial and antimicrobial fabrics available
- Different fabric on seat and back at no upcharge
- Casters, sled base not available
- CAL 133
- Other glides may be available for an upcharge - call Customer Service to inquire



Urban, Upholstered Seat & Back – Stools

COM 1.0 yd
0.5 yd COM per single seat
0.5 yd COM per single back

| MODEL | COM | GR1 | GR2 | GR3 | GR4 | GR5 | GR6 |
|----------------|------------|------------|------------|------------|------------|------------|------------|
| 1421-UP | 552 | 610 | 631 | 670 | 728 | 774 | 833 |
| 1425-UP | 552 | 610 | 631 | 670 | 728 | 774 | 833 |

Dimensions (inches)
seat H 28.0 seat W 18.0 arm H 37.0 total H 43.5
depth 22.0 total W 24.0 total W (no arms) 20.1

Exceeds BIFMA Seating Durability Test to 500 lbs
CAL 133, add \$62 List
1" extra seat foam, specify and add \$15 List



1421-UP
With arms
25 lbs



1425-UP
Without arms
24 lbs

Urban, Upholstered Seat & Back – Midsize Stools

COM 1.5 yd
0.75 yd COM per single seat
0.75 yd COM per single back

| MODEL | COM | GR1 | GR2 | GR3 | GR4 | GR5 | GR6 |
|----------------|------------|------------|------------|------------|------------|-------------|-------------|
| 1424-UP | 668 | 772 | 807 | 878 | 984 | 1065 | 1173 |
| 1426-UP | 668 | 772 | 807 | 878 | 984 | 1065 | 1173 |

Dimensions (inches)
seat H 28.0 seat W 22.0 arm H 37.0 total H 43.5
depth 22.0 total W 27.8 total W (no arms) 24.0

Exceeds BIFMA Seating Durability Test to 500 lbs
CAL 133, add \$87 List
1" extra seat foam, specify and add \$23 List



1424-UP
With arms
27 lbs



1426-UP
Without arms
26 lbs

URBAN Public Seating - UPHOLSTERED SEAT & BACK

Easy Access Hip Single Seater

Standard Features

- 0.875" frame
- Upholstered seat and back
- Frame in any Spectone color
- Ships 1/carton 19 cu ft

Contact Spec Customer Service to railroad fabrics (specify repeat info and yardage requirement will be provided) and for repeats greater than 5" x 5"

Options

- Specify back panel in Black RAL 9005, Light Grey RAL 7037 or White RAL 9016
- Polyurethane arms available in Black (B) or Sterling Grey (G)
- Antibacterial and antimicrobial fabrics available
- Different fabric on seat and back at no upcharge
- Casters, sled base not available
- CAL 133
- Other glides may be available for an upcharge - call Customer Service to inquire



Upholstered Back & Plastic Back Panel

Urban, Upholstered Seat & Back – Easy Access Hip Single Seater

COM 1.0 yd
0.5 yd COM per single seat
0.5 yd COM per single back

| MODEL | COM | GR1 | GR2 | GR3 | GR4 | GR5 | GR6 |
|-----------------|------------|------------|------------|------------|------------|------------|------------|
| 1421E-UP | 598 | 655 | 675 | 714 | 774 | 818 | 879 |

Dimensions (inches)
seat H 24.0 seat W 18.0 arm H 33.0
total H 38.5 total W 24.0 depth 32.0

Exceeds BIFMA Seating Durability Test to 500 lbs
CAL 133, add \$62 List
1" extra seat foam, specify and add \$15 List



1421E-UP
With arms
31 lbs

Urban, Upholstered Seat & Back – Midsize Easy Access Hip Single Seater

COM 1.5 yd
0.75 yd COM per single seat
0.75 yd COM per single back

| MODEL | COM | GR1 | GR2 | GR3 | GR4 | GR5 | GR6 |
|-----------------|------------|------------|------------|------------|-------------|-------------|-------------|
| 1424E-UP | 712 | 816 | 852 | 922 | 1029 | 1110 | 1218 |

Dimensions (inches)
seat H 24.0 seat W 22.0 arm H 33.0
total H 38.5 total W 27.8 depth 32.0

Exceeds BIFMA Seating Durability Test to 500 lbs
CAL 133, add \$87 List
1" extra seat foam, specify and add \$23 List



1424E-UP
With arms
33 lbs

URBAN Public Seating - WOOD BACK

Seat Back Designs

- Backs standard in Natural maple in any of 9 standard stains or stain-to-match at no upcharge

Custom Seat Back Cut-out

- A one time set up charge of \$279 list applies
- Design should fit within a 5" x 5" space (due to contour of back)
- Shape will be mirrored from the front of the chair

Pick a back design and add the name of the cutout following the model number, e.g. 1401Cityscape

Custom Seat Back Engraving and Vinyl Decals

- For quantities over 25, add an upcharge of \$57 List/chair
- For quantities under 25, add an upcharge of \$57 List/chair, plus a \$279 List set up fee **per order**

Engraving: Please note that inconsistencies in the wood may show after the engraving is completed. When choosing the raw wood, we take extra care to select backs that are similar in graining and color, however, no guarantee can be made. We recommend that an engraved image be stained a darker color to hide possible inconsistencies.

Urban – Wood Back Designs



Skyscraper



Cityscape



City Block

Custom Seat Back Cut-out



Custom Seat Back Engraving



Custom Seat Back Vinyl Decals*



* Available up to 4"x4"
Maximum of 4 colors per decal
Vector based files required



URBAN Public Seating - DOLLY

Standard Features

- Black finish only
- 2" black swivel casters
- Standard Dolly stacks 8 chairs
- Ships 1/carton 17 cu ft

Options

- Please specify if Dolly is for chairs with wall-saving frame



Urban – Dolly

| DESCRIPTION | MODEL | PRICE |
|---------------------|--------------|------------|
| Standard | 1499 | 367 |
| Midsized 22" | 1499M | 526 |

Dimensions (inches)

| Standard | | Midsized | |
|-----------------|------|-----------------|------|
| height | 36.5 | height | 36.5 |
| width | 21.0 | width | 23.0 |
| depth | 31.0 | depth | 42.0 |



**1499
Standard
18 lbs**

URBAN Public Seating - CONNECTED

To order connected Urban Chairs

- Select and price the Urban chair required for your configuration
- Select and price the corner, spacer and end tables required
- Add Urban connecting bars (between chairs only). Do not add connecting bars for tables (they are part of the table)
- Send a drawing with your order or call Spec for assistance

Connecting bars and tables can be retrofitted, allowing you to change configurations later or create new configurations from your present Urban chairs.

Connecting bars can be added to any Urban chair,

Connecting bars and table frame bars are finished in the same color as the color of the chair frames





Connecting bars are fastened to the underside of the Urban chair frame at the front and back

Urban Tables

- Table top is 3/4" thick
- Self Edge, PVC Flat and 2mm edge available. PVC Flat edge and 2 mm Bio edge available in 38 solid colors. 2mm PVC edge available in wood grain to match 9 standard stains.
- Select laminate tops from 15 standard laminates or choose any standard Wilsonart, Nevamar, Formica, Arborite and Pionite matte finish laminates at no upcharge.



Urban – Connecting Tables

| |  |  |  |  |  |
|---------------------|---|---|---|--|---|
| DESCRIPTION | Corner Table | Spacer Table | Mini Spacer Table | End Table* | Connecting Bars |
| MODEL | 14RC | 14ST | 14MT | 14ET | 14CON |
| DIMENSIONS (inches) | 25 x 25 | 17 x 17 | 4.5 x 14.5 | 17 x 17 | N/A |
| PRICE | 354 | 242 | 145 | 252 | 85 |
| | | | | *End table is handed, provide layout | |

2000 SERIES Lounge Seating

LAYOUTS



Description

- A popular choice for healthcare and institutional applications, 2000 Series combines great looks and comfort, with durability to meet real life demands.
- Available in one, two or three seaters as freestanding or connected.
- Your layout possibilities are unlimited with spacer, radius and corner tables – for both standard and bariatric seating in virtually any combination.
- Standard seat width is 22". Bariatric separate seat and back is a 30" wide seat and is load tested to 750 lbs. Cannot be connected to other bariatric seats.
- Zipper removable seats and backs are standard on separate seat and back designs.
- All models offer a choice of no center arms or half arm.
- Option of one piece or separate seat and back.
- Standard in 1.5" tube.
- Please send a drawing of the configuration you require with your order.
- Optional floor mounting is available.
- For fabrics you wish railroaded or repeats larger than 5" x 5", please contact the factory with repeat information and yardage requirement will be provided.



LAYOUTS AND DIMENSIONS

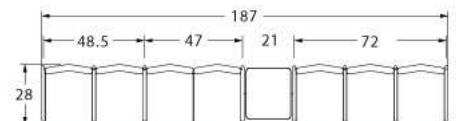
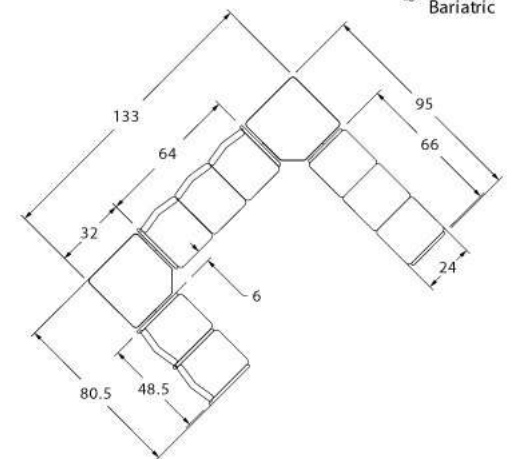
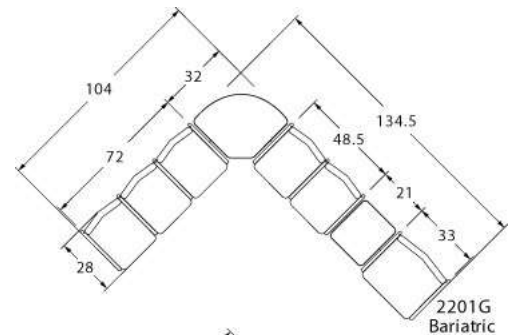



2000 SERIES Lounge Seating



PRODUCT CODE

2201C

| | | | |
|---|--|---|--|
| <p>Series 22 : 2000 Series</p> | <p>Arm/Other 0 : Outside Arm 1 : Half Arm 3 : Easy Access Hip Chair</p> | <p>Number of Seats 1 : Single Seater 2 : Two Seater 3 : Three Seater</p> | <p>Chair Type C : One Piece Seat and Back CS : Seperate Seat and Back G : Bariatric</p> |
|---|--|---|--|

OPTIONS

One-Piece Seat and Back

Separate Seat and Back



FINISHES

FRAME



Select from one of our 76 standard Spectone colors

FABRIC



Select fabrics from one of our textile partners

See Spectone Card or specfurniture.com/materials/finishes for a complete list of finish options and colors.

HOW TO ORDER

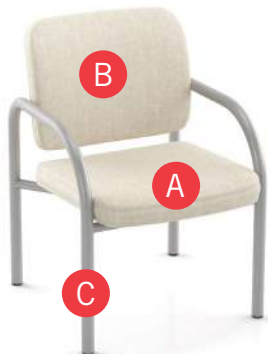

Specify Model

- A** Specify Fabric - Seat
Manufacturer, Pattern Name, Color
- B** Specify Fabric - Back
Manufacturer, Pattern Name, Color
- C** Specify Frame Finish

Optional: CAL 133, Moisture Barrier, Connecting Tables

| Model | Fabric - Seat | Fabric - Back | Frame Finish |
|--------|---------------------------|---------------------------|--------------|
| 2201CS | Momentum, Beeline, Canvas | Momentum, Beeline, Canvas | Silver |



2000 SERIES Lounge Seating

One Piece Single Seater with arms

Standard Features

- One piece seat and back
- Fully welded 1.5" frame
- Frame in any Spectone color
- Glides
- Use in connected layouts at no upcharge
- Ships assembled
- Ships 1/carton 17 cu ft

Options

- Connecting tables
- Antibacterial and antimicrobial fabrics available
- CAL 133

Contact Spec Customer Service to railroad fabrics (specify repeat info and yardage requirement will be provided) and for repeats greater than 5" x 5"



One Piece Single Seater with arms – Four-point

COM 1.75 yds

1.75 yd COM per single seat and back

| MODEL | COM | GR 1 | GR 2 | GR 3 | GR 4 | GR 5 | GR 6 |
|--------------|------------|------------|------------|------------|------------|-------------|-------------|
| 2201C | 693 | 782 | 812 | 872 | 963 | 1032 | 1123 |

Dimensions (inches)

| | | | | | |
|---------|------|---------|------|-------|------|
| seat H | 18.0 | seat W | 22.0 | arm H | 26.0 |
| total H | 35.0 | total W | 25.0 | depth | 26.5 |

Exceeds BIFMA Seating Durability Test to 500 lbs per chair

CAL 133, add \$108 List per chair



2201C
38 lbs



2000 SERIES Lounge Seating

One Piece Two and Three Seaters with outside arms

Standard Features

- One piece seat and back
- Fully welded 1.5" frame
- Frame in any Spectone color
- Glides
- Use in connected layouts at no upcharge
- Ships assembled
- Ships 1/carton 28 cu ft (2 seater),
1/carton 42 cu ft (3 seater)

Options

- Connecting tables
- Antibacterial and antimicrobial fabrics available
- CAL 133

Contact Spec Customer Service to railroad fabrics (specify repeat info and yardage requirement will be provided) and for repeats greater than 5" x 5"

One Piece Two Seater with outside arms – Four-point

COM 3.5 yds

1.75 yd COM per single seat and back

| MODEL | COM | GR 1 | GR 2 | GR 3 | GR 4 | GR 5 | GR 6 |
|--------------|-------------|-------------|-------------|-------------|-------------|-------------|-------------|
| 2202C | 1270 | 1452 | 1511 | 1633 | 1813 | 1951 | 2132 |

Dimensions (inches)

| | | | | | |
|---------|------|---------|------|-------|------|
| seat H | 18.0 | seat W | 22.0 | arm H | 26.0 |
| total H | 35.0 | total W | 47.0 | depth | 26.5 |

Exceeds BIFMA Seating Durability Test to 500 lbs per two seater
CAL 133, add \$216 List per two seater



2202C
68 lbs

One Piece Three Seater with outside arms – Four-point

COM 5.25 yds

1.75 yd COM per single seat and back

| MODEL | COM | GR 1 | GR 2 | GR 3 | GR 4 | GR 5 | GR 6 |
|--------------|-------------|-------------|-------------|-------------|-------------|-------------|-------------|
| 2203C | 1869 | 2140 | 2230 | 2411 | 2682 | 2890 | 3161 |

Dimensions (inches)

| | | | | | |
|---------|------|---------|------|-------|------|
| seat H | 18.0 | seat W | 22.0 | arm H | 26.0 |
| total H | 35.0 | total W | 69.0 | depth | 26.5 |

Exceeds BIFMA Seating Durability Test to 500 lbs per three seater
CAL 133, add \$324 List per three seater



2203C
98 lbs



2000 SERIES Lounge Seating

One Piece Two and Three Seaters with half arms

Standard Features

- One piece seat and back
- Fully welded 1.5" frame
- Frame in any Spectone color
- Glides
- Use in connected layouts at no upcharge
- Ships assembled
- Ships 1/carton 28 cu ft (2 seater),
1/carton 42 cu ft (3 seater)

Options

- Connecting tables
- Antibacterial and antimicrobial fabrics available
- CAL 133

Contact Spec Customer Service to railroad fabrics (specify repeat info and yardage requirement will be provided) and for repeats greater than 5" x 5"



One Piece Two Seater with half arms – Four-point

COM 3.5 yds

1.75 yd COM per single seat and back

| MODEL | COM | GR 1 | GR 2 | GR 3 | GR 4 | GR 5 | GR 6 |
|--------------|-------------|-------------|-------------|-------------|-------------|-------------|-------------|
| 2212C | 1383 | 1566 | 1626 | 1745 | 1926 | 2064 | 2243 |

Dimensions (inches)

| | | | | | |
|---------|------|---------|------|-------|------|
| seat H | 18.0 | seat W | 22.0 | arm H | 26.0 |
| total H | 35.0 | total W | 48.5 | depth | 26.5 |

Exceeds BIFMA Seating Durability Test to 500 lbs per two seater
CAL 133, add \$216 List per two seater



2212C
70 lbs

One Piece Three Seater with half arms – Four-point

COM 5.25 yds

1.75 yd COM per single seat and back

| MODEL | COM | GR 1 | GR 2 | GR 3 | GR 4 | GR 5 | GR 6 |
|--------------|-------------|-------------|-------------|-------------|-------------|-------------|-------------|
| 2213C | 2073 | 2346 | 2437 | 2617 | 2890 | 3096 | 3366 |

Dimensions (inches)

| | | | | | |
|---------|------|---------|------|-------|------|
| seat H | 18.0 | seat W | 22.0 | arm H | 26.0 |
| total H | 35.0 | total W | 72.0 | depth | 26.5 |

Exceeds BIFMA Seating Durability Test to 500 lbs per three seater
CAL 133, add \$324 List per three seater



2213C
99 lbs



2000 SERIES Lounge Seating

One Piece Easy Access Hip Single Seater with arms

Standard Features

- One piece seat and back
- Fully welded 1.5" frame
- Frame in any Spectone color
- Glides
- 24" seat height, no seat pitch (level)
- Footrest which assists entering/exiting chair
- Available only as four-point
- Ships assembled
- Ships 1/carton 19 cu ft

Options

- Antibacterial and antimicrobial fabrics available
- CAL 133

Contact Spec Customer Service to railroad fabrics (specify repeat info and yardage requirement will be provided) and for repeats greater than 5" x 5"



One Piece Easy Access Hip Single Seater with arms

COM 1.75 yds
1.75 yd COM per single seat and back

| MODEL | COM | GR 1 | GR 2 | GR 3 | GR 4 | GR 5 | GR 6 |
|--------------|------------|------------|------------|------------|-------------|-------------|-------------|
| 2231C | 796 | 885 | 915 | 976 | 1066 | 1134 | 1225 |

Dimensions (inches)

| | | | | | |
|---------|------|---------|------|-------|------|
| seat H | 24.0 | seat W | 22.0 | arm H | 30.5 |
| total H | 38.0 | total W | 25.0 | depth | 26.5 |

Exceeds BIFMA Seating Durability Test to 500 lbs per chair
CAL 133, add \$108 List per chair



2231C
45 lbs



2000 SERIES Lounge Seating

Separate Seat and Back Single Seater with arms – Four-point

Standard Features

- Separate seat and back
- Fully welded 1.5" frame
- Frame in any Spectone color
- Glides
- Zippered removable covers
- Use in connected layouts at no upcharge
- Ships assembled
- Ships 1/carton 17 cu ft

Options

- Connecting tables
- Antibacterial and antimicrobial fabrics available
- Different fabric on seat and back at no upcharge
- CAL 133

Contact Spec Customer Service to railroad fabrics (specify repeat info and yardage requirement will be provided) and for repeats greater than 5" x 5"



Separate Seat and Back Single Seater with arms – Four-point

COM 1.75 yds
 1.0 yd COM per single seat
 0.75 yd COM per single back

| MODEL | COM | GR 1 | GR 2 | GR 3 | GR 4 | GR 5 | GR 6 |
|---------------|------------|------------|-------------|-------------|-------------|-------------|-------------|
| 2201CS | 895 | 986 | 1018 | 1077 | 1167 | 1237 | 1325 |

Dimensions (inches)

| | | | | | |
|---------|------|---------|------|-------|------|
| seat H | 18.0 | seat W | 22.0 | arm H | 26.0 |
| total H | 35.0 | total W | 25.0 | depth | 26.5 |

Exceeds BIFMA Seating Durability Test to 500 lbs per chair
 CAL 133, add \$108 List per chair



2201CS
38 lbs



2000 SERIES Lounge Seating

Separate Seat and Back Two and Three Seaters with outside arms – Four-point

Standard Features

- Separate seat and back
- Fully welded 1.5" frame
- Frame in any Spectone color
- Glides
- Zippered removable covers
- Use in connected layouts at no upcharge
- Ships assembled
- Ships 1/carton 28 cu ft (2 seater),
1/carton 42 cu ft (3 seater)

Options

- Connecting tables
- Antibacterial and antimicrobial fabrics available
- Different fabric on seat and back at no upcharge
- CAL 133

Contact Spec Customer Service to railroad fabrics (specify repeat info and yardage requirement will be provided) and for repeats greater than 5" x 5"



Separate Seat and Back Two Seater with outside arms – Four-point

COM 3.5 yds
1.0 yd COM per single seat
0.75 yd COM per single back

| MODEL | COM | GR 1 | GR 2 | GR 3 | GR 4 | GR 5 | GR 6 |
|---------------|-------------|-------------|-------------|-------------|-------------|-------------|-------------|
| 2202CS | 1604 | 1786 | 1846 | 1966 | 2148 | 2285 | 2465 |

Dimensions (inches)
seat H 18.0 seat W 22.0 arm H 26.0
total H 35.0 total W 47.0 depth 26.5

Exceeds BIFMA Seating Durability Test to 500 lbs per two seater
CAL 133, add \$216 List per two seater



2202CS
68 lbs

Separate Seat and Back Three Seater with outside arms – Four-point

COM 5.25 yds
1.0 yd COM per single seat
0.75 yd COM per single back

| MODEL | COM | GR 1 | GR 2 | GR 3 | GR 4 | GR 5 | GR 6 |
|---------------|-------------|-------------|-------------|-------------|-------------|-------------|-------------|
| 2203CS | 2378 | 2648 | 2738 | 2917 | 3190 | 3398 | 3669 |

Dimensions (inches)
seat H 18.0 seat W 22.0 arm H 26.0
total H 35.0 total W 69.0 depth 26.5

Exceeds BIFMA Seating Durability Test to 500 lbs per three seater
CAL 133, add \$324 List per three seater



2203CS
98 lbs



2000 SERIES Lounge Seating

Separate Seat and Back Two and Three Seaters with half arms – Four-point

Standard Features

- Separate seat and back
- Fully welded 1.5" frame
- Frame in any Spectone color
- Glides
- Zippered removable covers
- Use in connected layouts at no upcharge
- Ships assembled
- Ships 1/carton 28 cu ft (2 seater),
1/carton 42 cu ft (3 seater)

Options

- Connecting tables
- Antibacterial and antimicrobial fabrics available
- Different fabric on seat and back at no upcharge
- CAL 133

Contact Spec Customer Service to railroad fabrics (specify repeat info and yardage requirement will be provided) and for repeats greater than 5" x 5"

Separate Seat and Back Two Seater with half arms – Four-point

COM 3.5 yds
1.0 yd COM per single seat
0.75 yd COM per single back

| MODEL | COM | GR 1 | GR 2 | GR 3 | GR 4 | GR 5 | GR 6 |
|---------------|-------------|-------------|-------------|-------------|-------------|-------------|-------------|
| 2212CS | 1792 | 1972 | 2031 | 2152 | 2334 | 2470 | 2653 |

Dimensions (inches)
seat H 18.0 seat W 22.0 arm H 26.0
total H 35.0 total W 48.5 depth 26.5

Exceeds BIFMA Seating Durability Test to 500 lbs per two seater
CAL 133, add \$216 List per two seater



2212CS
70 lbs

Separate Seat and Back Three Seater with half arms – Four-point

COM 5.25 yds
1.0 yd COM per single seat
0.75 yd COM per single back

| MODEL | COM | GR 1 | GR 2 | GR 3 | GR 4 | GR 5 | GR 6 |
|---------------|-------------|-------------|-------------|-------------|-------------|-------------|-------------|
| 2213CS | 2687 | 2958 | 3049 | 3229 | 3500 | 3708 | 3978 |

Dimensions (inches)
seat H 18.0 seat W 22.0 arm H 26.0
total H 35.0 total W 72.0 depth 26.5

Exceeds BIFMA Seating Durability Test to 500 lbs per three seater
CAL 133, add \$324 List per three seater



2213CS
99 lbs



2000 SERIES Lounge Seating

Separate Seat and Back Bariatric Single Seater with arms

Standard Features

- Separate seat and back
- Fully welded 1.5" frame
- Frame in any Spectone color
- Glides
- Zippered removable covers
- Use in connected layouts at no upcharge
- Available only as separate seat and back
- Available only as four-point
- Cannot connect bariatric to bariatric seating
- Ships assembled
- Ships 1/carton 22 cu ft

Options

- Connecting tables
- Antibacterial and antimicrobial fabrics available
- Different fabric on seat and back at no upcharge
- CAL 133

Contact Spec Customer Service to railroad fabrics (specify repeat info and yardage requirement will be provided) and for repeats greater than 5" x 5"



Separate Seat and Back Bariatric Single Seater with arms

COM 3.0 yds
 1.5 yd COM per single seat
 1.5 yd COM per single back

| MODEL | COM | GR 1 | GR 2 | GR 3 | GR 4 | GR 5 | GR 6 |
|--------------|-------------|-------------|-------------|-------------|-------------|-------------|-------------|
| 2201G | 1147 | 1314 | 1368 | 1478 | 1645 | 1771 | 1936 |

Dimensions (inches)

| | | | | | |
|---------|------|---------|------|-------|------|
| seat H | 18.0 | seat W | 30.0 | arm H | 26.0 |
| total H | 35.0 | total W | 33.0 | depth | 26.5 |

Exceeds BIFMA Seating Durability Test to 750 lbs per chair
 CAL 133, add \$134 List per chair



2201G
48 lbs



2000 SERIES Lounge Seating

Separate Seat and Back Easy Access Hip Single Seater with arms

Standard Features

- Separate seat and back
- Fully welded 1.5" frame
- Frame in any Spectone color
- Glides
- Zippered removable covers
- 24" seat height, no seat pitch (level)
- Footrest which assists entering/exiting chair
- Available only as four-point
- Ships assembled
- Ships 1/carton 19 cu ft

Options

- Antibacterial and antimicrobial fabrics available
- Different fabric on seat and back at no upcharge
- CAL 133

Contact Spec Customer Service to railroad fabrics (specify repeat info and yardage requirement will be provided) and for repeats greater than 5" x 5"



Separate Seat and Back Easy Access Hip Single Seater with arms

COM 1.75 yds
 1.0 yd COM per single seat
 0.75 yd COM per single back

| MODEL | COM | GR 1 | GR 2 | GR 3 | GR 4 | GR 5 | GR 6 |
|---------------|------------|-------------|-------------|-------------|-------------|-------------|-------------|
| 2231CS | 998 | 1088 | 1120 | 1180 | 1269 | 1340 | 1428 |

Dimensions (inches)

| | | | | | |
|---------|------|---------|------|-------|-------|
| seat H | 24.0 | seat W | 22.0 | arm H | 30.25 |
| total H | 38.0 | total W | 25.0 | depth | 26.5 |

Exceeds BIFMA Seating Durability Test to 500 lbs per chair
 CAL 133, add \$108 List per chair



2231CS
45 lbs



2000 SERIES Lounge Seating

Freestanding Lounge Tables
Corner and Spacer Connecting Tables

Standard Features

- Tops in laminate or veneer
- Select from 15 standard laminates or choose any standard Wilsonart, Nevamar, Formica, Arborite and Pionite matte finish laminates at no upcharge
- Table tops available with PVC Flat edge (PVF) or Self edge (SE)
- 9 standard hardwood edge stains. Stain-to-match available at no upcharge.
- Frame in any Spectone color
- Glides
- Tops utilize NU Green earth friendly core

Options

- Non-standard laminates, contact Spec for pricing
- Custom size spacer tables for restricted spaces
- Other sizes may be available

Radius Corner Tables are recommended for open areas



Corner and Spacer Connecting Tables

| Model | Laminate PVF/SE | Weight | Cu.Ft. |
|---|--------------------|-----------|----------|
| 22RC/23RC 32 x 32 <i>Radius Corner Table</i> | 704 | 31 | 2 |
| 22SC/23SC 32 x 32 <i>Square Corner Table</i> | 704 | 32 | 2 |
| 22TC45/23TC45 19 x 23 <i>45 degree Corner Table</i> | 542 | 26 | 2 |
| 22ST/23ST 21 x 24 <i>Spacer or End Table</i> | 542 | 21 | 2 |

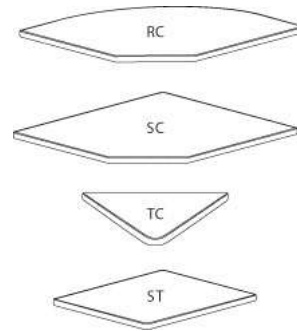



TABLES

ACUTE TABLES



PRODUCT CODE

2430 RE T A

Top Size
Width x Length

Top Shape
D : Round
SQ : Square
RE : Rectangle
RT : Racetrack
B : Bullet
H : Halfmoon
TP : Trapezoid

C90 : Radius
CRC90 : Crescent
BT : Boatshape
BTA : Boatshape Arc

Base
X : X-Base
X4 : 4 Column X-Base
T : T-Base
T2 : Double Column T-Base

Series
Acute

OPTIONS

FLIP TOP



CASTERS



FOLDING



FINISHES

LAMINATE

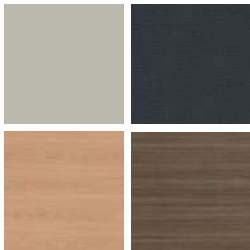

Select from 15 standard laminates or choose any standard Wilsonart, Nevamar, Formica, Arborite and Pionite matte finish laminates at no upcharge

VENEER

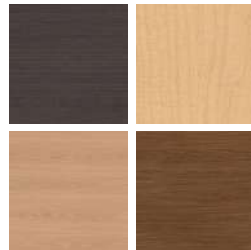

Select from one of our 9 standard wood stains or stain-to-match at no upcharge

BASE



Select from one of our 76 standard Spectone colors

EDGE



See Spectone Card or specfurniture.com/materials/finishes for a complete list of finish options and colors.

ACUTE TABLES

HOW TO ORDER



Specify Top Size (Width x Length) and Shape

- A** Specify Top Type and Finish
For Laminate Top: Manufacturer, Laminate Name, Laminate Code
For Veneer Top: Wood Stain
- B** Specify Edge Type, (for hardwood: Style), and Finish
PVC/2mm/Self Edge/Exposed Baltic Birch Plywood/Hardwood
- C** Specify Base Style and Finish

Optional: Flip Top, Fold, Modesty Panels, Seam Connectors, Hard Casters, Soft Casters, Adjustable Height, Power and Data Modules, Custom Solutions

Restrictions may apply. See price list tables below for more information.



| Top Size and Shape | Top Type and Finish | Edge Type, Style and Finish | Base Style and Finish |
|--------------------|---------------------------------|--|-----------------------|
| 24 x 72, Rectangle | Laminate, Arborite, Brown Sugar | Hardwood, HF, Custom Brown Sugar Stain | TA, Silver |

EDGE PROFILES

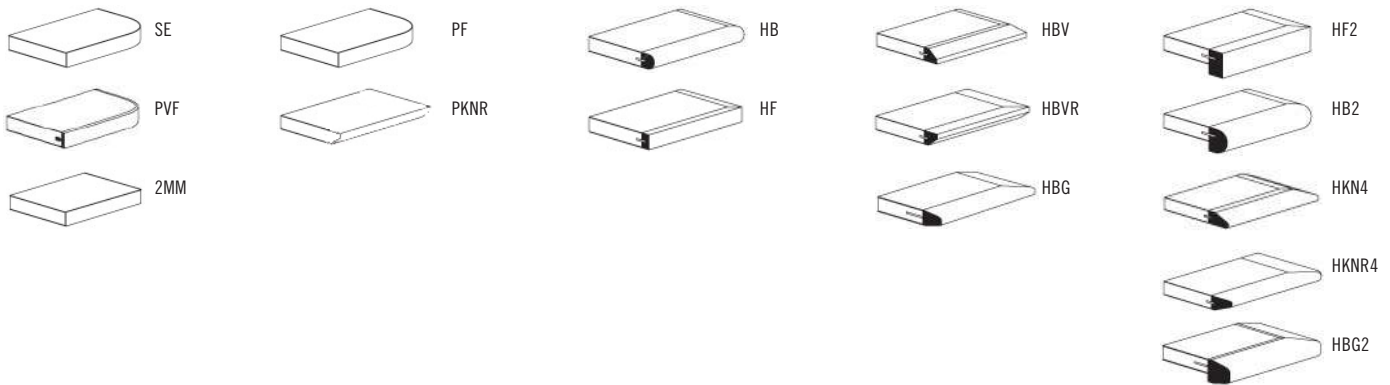



ACUTE TABLES

GENERAL PURPOSE



| MODEL | BASES | | TOP SPECIFICATIONS | | | | | | OPTIONS | | | | LBS |
|---------------|-------|------|--------------------|--|--------------------|-----------------------------|------------------------|-----------------------------|---------------|------------|-------------------|-------------------|-----|
| | Code | Qty. | For Laminate Top | | | For Veneer Top | | | FLIP TOP (FT) | FOLD* (FL) | HARD CASTERS (HC) | SOFT CASTERS (SC) | |
| | | | SE PVF 2MM | HF HB PKNR ¹ PF ¹ | HBV HBVR HBG | HF2 HB2 HKNR4 HBG2 | HF HB HBV HBG | HF2 HB2 HKNR4 HBG2 | | | | | |
| <i>Round</i> | | | | | | | | | | | | | |
| 24D | XA | 1 | 520 | 880 | 917 | 1026 | 1085 | 1197 | 154 | | | | 37 |
| 30D | XA | 1 | 624 | 979 | 1026 | 1244 | 1189 | 1353 | 154 | | | | 47 |
| 36D | XA | 1 | 723 | 1236 | 1327 | 1505 | 1559 | 1788 | 154 | | | | 58 |
| 42D | XA | 1 | 1008 | 1584 | 1708 | 1973 | 1999 | 2312 | 154 | | | | 72 |
| | X4A | 1 | 1204 | 1780 | 1904 | 2169 | 2195 | 2508 | | | 96 | 204 | 87 |
| 48D | XA | 1 | 1031 | 1804 | 1939 | 2071 | 2545 | 2947 | 154 | | 96 | 204 | 88 |
| | X4A | 1 | 1227 | 2000 | 2135 | 2267 | 2741 | 3143 | | | 96 | 204 | 103 |
| 54D | X4A | 1 | 1517 | 2657 | 2867 | 3067 | 3303 | 3819 | | | | | 121 |
| 60D | X4A | 1 | 1565 | 2859 | 3083 | 3252 | 3938 | 4579 | | | | | 140 |
| <i>Square</i> | | | | | | | | | | | | | |
| 24 x 24SQ | XA | 1 | 551 | 746 | 783 | 851 | 901 | 1068 | 154 | | 96 | 204 | 37 |
| 30 x 30SQ | XA | 1 | 658 | 800 | 851 | 1031 | 965 | 1197 | 154 | | 96 | 204 | 47 |
| 36 x 36SQ | XA | 1 | 741 | 964 | 1026 | 1236 | 1244 | 1444 | 154 | | 96 | 204 | 58 |
| 42 x 42SQ | XA | 1 | 1176 | 1499 | 1598 | 1698 | 1767 | 2040 | 310 | | | | 92 |
| | X4A | 1 | 1218 | 1541 | 1640 | 1740 | 1809 | 2082 | | | 96 | 204 | 87 |
| 48 x 48SQ | X4A | 1 | 1372 | 1655 | 1760 | 1807 | 2185 | 2538 | | | 96 | 204 | 103 |
| 54 x 54SQ | X4A | 1 | 1520 | 2144 | 2308 | 2498 | 2602 | 3059 | | | | | 121 |
| 60 x 60SQ | X4A | 1 | 1550 | 2250 | 2425 | 2616 | 3081 | 3634 | | | | | 140 |

*Folding tables available with PVC Flat (PVF) edge only.

¹ Exposed Baltic Birch plywood edge (PKNR, PF) can only be specified on square tops up to 47-1/2" x 95-1/2". Clear finish only.



STANDARD FEATURES

- Select from 15 standard laminates or choose any standard Wilsonart, Nevamar, Formica, Arborite and Pionite matte finish laminates at no upcharge. For other laminate please contact the factory for pricing.
- 9 standard veneer and hardwood edge stains. Stain-to-match available at no upcharge.
- Standard table height 29".
- All bases are standard with floor leveling glides.

OPTIONS

- Custom heights available.
- For applicable Power & Data modules, please see Table Accessories Price List.

HOW TO ORDER

1. Select Model
2. Select Base
3. Select Edge Style
4. Select Options
5. Select Top Finish
6. Select Edge Finish
7. Select Base Finish

Example: 24D - XA - PVF -





ACUTE TABLES GENERAL PURPOSE

| MODEL | BASES | | TOP SPECIFICATIONS | | | | | | OPTIONS | | | | LBS |
|------------------|-------|------|--------------------|---|--------------|--------------------|---------------------|--------------------|---------------|------------|-------------------|-------------------|-----|
| | Code | Qty. | For Laminate Top | | | For Veneer Top | | | FLIP TOP (FT) | FOLD* (FL) | HARD CASTERS (HC) | SOFT CASTERS (SC) | |
| | | | SE PVF 2MM | HF HB PKNR ¹ PF ¹ | HBV HBVR HBG | HF2 HB2 HKNR4 HBG2 | HF HB HBV HBNR4 HBG | HF2 HB2 HKNR4 HBG2 | | | | | |
| <i>Rectangle</i> | | | | | | | | | | | | | |
| 24 x 30RE | XA | 1 | 647 | 779 | 828 | 896 | 949 | 1080 | 154 | | | | 46 |
| | TA | 2 | 758 | 890 | 939 | 1007 | 1060 | 1191 | 310 | | 96 | 204 | 54 |
| 24 x 36RE | XA | 1 | 647 | 779 | 828 | 896 | 949 | 1080 | 154 | | | | 46 |
| | TA | 2 | 758 | 890 | 939 | 1007 | 1060 | 1191 | 310 | | 96 | 204 | 54 |
| 24 x 42RE | TA | 2 | 823 | 1038 | 1094 | 1195 | 1256 | 1437 | 310 | | 96 | 204 | 62 |
| 24 x 48RE | TA | 2 | 823 | 1038 | 1094 | 1195 | 1256 | 1437 | 310 | | 96 | 204 | 62 |
| 24 x 54RE | TA | 2 | 884 | 1197 | 1267 | 1383 | 1470 | 1692 | 310 | | 96 | 204 | 70 |
| 24 x 60RE | TA | 2 | 884 | 1197 | 1267 | 1383 | 1470 | 1692 | 310 | 297 | 96 | 204 | 70 |
| 24 x 66RE | TA | 2 | 1032 | 1409 | 1495 | 1637 | 1728 | 2000 | 310 | 297 | 96 | 204 | 79 |
| 24 x 72RE | TA | 2 | 1032 | 1409 | 1495 | 1637 | 1728 | 2000 | 310 | 297 | 96 | 204 | 79 |
| 30 x 36RE | XA | 1 | 741 | 896 | 950 | 1039 | 1101 | 1259 | 154 | | | | 52 |
| | TA | 2 | 852 | 1007 | 1061 | 1150 | 1212 | 1370 | 310 | | 96 | 204 | 60 |
| 30 x 42RE | XA | 1 | 763 | 1057 | 1124 | 1240 | 1326 | 1546 | 154 | | | | 62 |
| | TA | 2 | 874 | 1168 | 1235 | 1351 | 1437 | 1657 | 310 | | 96 | 204 | 70 |
| 30 x 48RE | XA | 1 | 763 | 1057 | 1124 | 1240 | 1326 | 1546 | 154 | | | | 62 |
| | TA | 2 | 874 | 1168 | 1235 | 1351 | 1437 | 1657 | 310 | | 96 | 204 | 70 |
| 30 x 54RE | TA | 2 | 935 | 1335 | 1422 | 1588 | 1686 | 1962 | 310 | | 96 | 204 | 81 |
| 30 x 60RE | TA | 2 | 935 | 1335 | 1422 | 1588 | 1686 | 1962 | 310 | 297 | 96 | 204 | 81 |
| 30 x 66RE | TA | 2 | 1111 | 1436 | 1542 | 1709 | 1805 | 2110 | 310 | 297 | 96 | 204 | 91 |
| 30 x 72RE | TA | 2 | 1169 | 1592 | 1699 | 1915 | 2028 | 2364 | 310 | 297 | 96 | 204 | 91 |

*Folding tables available with PVC Flat (PVF) edge only.

¹ Exposed Baltic Birch plywood edge (PKNR, PF) can only be specified on tops up to 47-1/2" x 95-1/2". Clear finish only.



30D-XA (shown with round top) 2448RE-TA

STANDARD FEATURES

- Select from 15 standard laminates or choose any standard Wilsonart, Nevamar, Formica, Arborite and Pionite matte finish laminates at no upcharge. For other laminate please contact the factory for pricing.
- 9 standard veneer and hardwood edge stains. Stain-to-match available at no upcharge.
- Standard table height 29".
- All bases are standard with floor leveling glides.

OPTIONS

- Custom heights available.
- For applicable Power & Data modules, please see Table Accessories Price List.

HOW TO ORDER

1. Select Model
2. Select Base
3. Select Edge Style
4. Select Options
5. Select Top Finish
6. Select Edge Finish
7. Select Base Finish

Example: 2430RE - XA - PVF -





ACUTE TABLES

GENERAL PURPOSE

| MODEL | BASES | | TOP SPECIFICATIONS | | | | | | OPTIONS | | | | LBS |
|------------------|-------|------|--------------------|-------------------|------|----------------|------|-------|---------------|------------|-------------------|-------------------|-----|
| | Code | Qty. | For Laminate Top | | | For Veneer Top | | | FLIP TOP (FT) | FOLD* (FL) | HARD CASTERS (HC) | SOFT CASTERS (SC) | |
| | | | SE | HF | HBV | HF2 | HF | HF2 | | | | | |
| | | | PVF | HB | HBVR | HB2 | HB | HB2 | | | | | |
| | | | 2MM | PKNR ¹ | HBG | HKNR4 | HBVR | HKNR4 | | | | | |
| | | | | PF ¹ | | HKG2 | HKG | HKG2 | | | | | |
| <i>Rectangle</i> | | | | | | | | | | | | | |
| 30 x 78RE | TA | 2 | 1397 | 1772 | 1899 | 2150 | 2282 | 2668 | 310 | 297 | 96 | 204 | 102 |
| 30 x 84RE | TA | 2 | 1397 | 1772 | 1899 | 2150 | 2282 | 2668 | 310 | 297 | 96 | 204 | 102 |
| 30 x 90RE | TA | 2 | 1419 | 1997 | 2150 | 2382 | 2538 | 2978 | | 297 | 96 | 204 | 112 |
| 30 x 96RE | TA | 2 | 1419 | 1997 | 2150 | 2382 | 2538 | 2978 | | 297 | 96 | 204 | 112 |
| 36 x 42RE | TA | 2 | 976 | 1197 | 1281 | 1396 | 1486 | 1717 | 310 | | 96 | 204 | 79 |
| 36 x 48RE | TA | 2 | 1001 | 1313 | 1404 | 1542 | 1633 | 1904 | 310 | | 96 | 204 | 79 |
| 36 x 60RE | TA | 2 | 1100 | 1534 | 1644 | 1820 | 1931 | 2269 | 310 | 297 | 96 | 204 | 91 |
| 36 x 66RE | TA | 2 | 1190 | 1640 | 1767 | 1960 | 2082 | 2453 | 310 | 297 | 96 | 204 | 104 |
| | T2A | 2 | 1394 | 1844 | 1971 | 2164 | 2286 | 2657 | | 597 | 96 | 204 | 124 |
| 36 x 72RE | TA | 2 | 1229 | 1699 | 1820 | 2099 | 2235 | 2636 | 310 | 297 | 96 | 204 | 104 |
| | T2A | 2 | 1433 | 1903 | 2024 | 2303 | 2439 | 2840 | | 597 | 96 | 204 | 124 |
| 36 x 78RE | TA | 2 | 1570 | 2073 | 2231 | 2474 | 2632 | 3105 | | 297 | 96 | 204 | 117 |
| | T2A | 2 | 1774 | 2277 | 2435 | 2678 | 2836 | 3309 | | 597 | 96 | 204 | 137 |
| 36 x 84RE | TA | 2 | 1570 | 2073 | 2231 | 2474 | 2632 | 3105 | | 297 | 96 | 204 | 117 |
| | T2A | 2 | 1774 | 2277 | 2435 | 2678 | 2836 | 3309 | | 597 | 96 | 204 | 137 |
| 36 x 90RE | TA | 2 | 1577 | 2294 | 2474 | 2757 | 2939 | 3463 | | | 96 | 204 | 129 |
| | T2A | 2 | 1781 | 2498 | 2678 | 2961 | 3143 | 3667 | | 597 | 96 | 204 | 149 |
| 36 x 96RE | TA | 2 | 1577 | 2294 | 2474 | 2757 | 2939 | 3463 | | | 96 | 204 | 129 |
| | T2A | 2 | 1781 | 2498 | 2678 | 2961 | 3143 | 3667 | | 597 | 96 | 204 | 149 |
| 42 x 78RE | T2A | 2 | 2022 | 2454 | 2627 | 3045 | 3182 | 3730 | | 597 | 96 | 204 | 151 |
| 42 x 84RE | T2A | 2 | 2022 | 2454 | 2627 | 3045 | 3182 | 3730 | | 597 | 96 | 204 | 151 |

*Folding tables available with PVC Flat (PVF) edge only.

¹ Exposed Baltic Birch plywood edge (PKNR, PF) can only be specified on tops up to 47-1/2" x 95-1/2". Clear finish only.



2448RE-TA

STANDARD FEATURES

- Select from 15 standard laminates or choose any standard Wilsonart, Nevamar, Formica, Arborite and Pionite matte finish laminates at no upcharge. For other laminate please contact the factory for pricing.
- 9 standard veneer and hardwood edge stains. Stain-to-match available at no upcharge.
- Standard table height 29".
- All bases are standard with floor leveling glides.

OPTIONS

- Custom heights available.
- For applicable Power & Data modules, please see Table Accessories Price List.

HOW TO ORDER

1. Select Model
2. Select Base
3. Select Edge Style
4. Select Options
5. Select Top Finish
6. Select Edge Finish
7. Select Base Finish

Example: 3078RE - TA - PVF -





ACUTE TABLES

GENERAL PURPOSE

| MODEL | BASES | | TOP SPECIFICATIONS | | | | | | OPTIONS | | | LBS |
|------------------|-------|------|--------------------|----------|--------------------|-----------------------------|------------------------|-----------------------------|---------------|-------------------|-------------------|-----|
| | Code | Qty. | For Laminate Top | | | For Veneer Top | | | FLIP TOP (FT) | HARD CASTERS (HC) | SOFT CASTERS (SC) | |
| | | | SE PVF 2MM | HF HB | HBV HBVR HBG | HF2 HB2 HKNR4 HBG2 | HF HB HBV HBG | HF2 HB2 HKNR4 HBG2 | | | | |
| <i>Racetrack</i> | | | | | | | | | | | | |
| 36 x 54RT | TA | 2 | 1157 | 1728 | 1861 | 2099 | 2197 | 2546 | 310 | 96 | 204 | 91 |
| | T2A | 2 | 1361 | 1932 | 2065 | 2303 | 2401 | 2750 | | | | |
| 36 x 60RT | TA | 2 | 1157 | 1728 | 1861 | 2099 | 2197 | 2546 | 310 | 96 | 204 | 91 |
| | T2A | 2 | 1361 | 1932 | 2065 | 2303 | 2401 | 2750 | | | | |
| 36 x 66RT | TA | 2 | 1318 | 1915 | 2059 | 2314 | 2538 | 2974 | 310 | 96 | 204 | 104 |
| | T2A | 2 | 1522 | 2119 | 2263 | 2518 | 2742 | 3178 | | | | |
| 36 x 72RT | TA | 2 | 1318 | 1915 | 2059 | 2314 | 2538 | 2974 | 310 | 96 | 204 | 104 |
| | T2A | 2 | 1522 | 2119 | 2263 | 2518 | 2742 | 3178 | | | | |
| 36 x 78RT | TA | 2 | 1588 | 2346 | 2523 | 2908 | 2989 | 3497 | | 96 | 204 | 117 |
| | T2A | 2 | 1792 | 2550 | 2727 | 3112 | 3193 | 3701 | | | | |
| 36 x 84RT | TA | 2 | 1588 | 2346 | 2523 | 2908 | 2989 | 3497 | | 96 | 204 | 117 |
| | T2A | 2 | 1792 | 2550 | 2727 | 3112 | 3193 | 3701 | | | | |
| 36 x 90RT | TA | 2 | 1592 | 2603 | 2814 | 3245 | 3346 | 3925 | | 96 | 204 | 129 |
| | T2A | 2 | 1796 | 2807 | 3018 | 3449 | 3550 | 4129 | | | | |
| 36 x 96RT | TA | 2 | 1592 | 2603 | 2814 | 3245 | 3346 | 3925 | | 96 | 204 | 129 |
| | T2A | 2 | 1796 | 2807 | 3018 | 3449 | 3550 | 4129 | | | | |
| 42 x 78RT | T2A | 2 | 2037 | 2754 | 2971 | 3407 | 3512 | 4096 | | 96 | 204 | 166 |
| 42 x 84RT | T2A | 2 | 2037 | 2754 | 2971 | 3407 | 3512 | 4096 | | 96 | 204 | 166 |
| 48 x 78RT | T2A | 2 | 2040 | 3062 | 3308 | 3694 | 3935 | 4599 | | 96 | 204 | 166 |
| 48 x 84RT | T2A | 2 | 2040 | 3062 | 3308 | 3694 | 3935 | 4599 | | 96 | 204 | 166 |



2448RE-TA (shown with rectangle top)

STANDARD FEATURES

- Select from 15 standard laminates or choose any standard Wilsonart, Nevamar, Formica, Arborite and Pionite matte finish laminates at no upcharge. For other laminate please contact the factory for pricing.
- 9 standard veneer and hardwood edge stains. Stain-to-match available at no upcharge.
- Standard table height 29".
- All bases are standard with floor leveling glides.

OPTIONS

- Custom heights available.
- For applicable Power & Data modules, please see Table Accessories Price List.

HOW TO ORDER

1. Select Model
2. Select Base
3. Select Edge Style
4. Select Options
5. Select Top Finish
6. Select Edge Finish
7. Select Base Finish

Example: 3654RT - TA - PVF -





ACUTE TABLES GENERAL PURPOSE



| MODEL | BASES | | TOP SPECIFICATIONS | | | | | | OPTIONS | | | LBS |
|------------------|--------------|------|--------------------|----------|--------------------|----------------------------|------------------------|----------------------------|---------------|-------------------|-------------------|-----|
| | Code | Qty. | For Laminate Top | | | For Veneer Top | | | FLIP TOP (FT) | HARD CASTERS (HC) | SOFT CASTERS (SC) | |
| | | | SE PVF 2MM | HF HB | HBV HBVR HBG | HF2 HB2 HKN4 HBG2 | HF HB HBV HBG | HF2 HB2 HKN4 HBG2 | | | | |
| <i>Bullet</i> | | | | | | | | | | | | |
| 30 x 54B | TA | 2 | 1056 | 1625 | 1744 | 1952 | 2014 | 2358 | 310 | 96 | 204 | 81 |
| 30 x 60B | TA | 2 | 1056 | 1625 | 1744 | 1952 | 2014 | 2358 | 310 | 96 | 204 | 81 |
| 36 x 54B | TA | 2 | 1179 | 2136 | 2305 | 2610 | 2652 | 3085 | 310 | 96 | 204 | 91 |
| 36 x 60B | TA | 2 | 1179 | 2136 | 2305 | 2610 | 2652 | 3085 | 310 | 96 | 204 | 91 |
| 36 x 72B | TA | 2 | 1317 | 2375 | 2562 | 2888 | 3077 | 3621 | 310 | 96 | 204 | 104 |
| <i>Halfmoon</i> | | | | | | | | | | | | |
| 24 x 48H | TA | 2 | 841 | 1355 | 1484 | 1640 | 1767 | 2059 | 310 | 96 | 204 | 62 |
| 30 x 60H | TA | 2 | 1056 | 1821 | 1998 | 2174 | 2394 | 2811 | 310 | 96 | 204 | 81 |
| 36 x 72H | TA | 2 | 1317 | 2361 | 2592 | 2808 | 3165 | 3729 | 310 | 96 | 204 | 104 |
| <i>Trapezoid</i> | | | | | | | | | | | | |
| 30 x 60TP | TA | 2 | 1056 | 1527 | 1637 | 1826 | 1881 | 2200 | 310 | 96 | 204 | 81 |
| 36 x 72TP | TA | 2 | 1317 | 1956 | 2100 | 2428 | 2510 | 2970 | 310 | 96 | 204 | 104 |
| <i>Radius</i> | | | | | | | | | | | | |
| 24 x 24 | 24RC90 | - | 395 | 717 | 810 | 929 | 952 | 1140 | | | | 17 |
| 30 x 30 | 30RC90 | - | 504 | 948 | 1066 | 1195 | 1263 | 1515 | | | | 27 |
| <i>Crescent</i> | | | | | | | | | | | | |
| 30 x 36 | 3036CRC90-TA | 1 | 805 | 1491 | 1578 | 1646 | 1864 | 2103 | | | | 46 |
| 36 x 42 | 3642CRC90-TA | 1 | 1168 | 1812 | 1931 | 2020 | 2320 | 2644 | | | | 59 |



2448RE-TA (shown with rectangle top)

STANDARD FEATURES

- Select from 15 standard laminates or choose any standard Wilsonart, Nevamar, Formica, Arborite and Pionite matte finish laminates at no upcharge. For other laminate please contact the factory for pricing.
- 9 standard veneer and hardwood edge stains. Stain-to-match available at no upcharge.
- Standard table height 29".
- All bases are standard with floor leveling glides.

OPTIONS

- Custom heights available.
- For applicable Power & Data modules, please see Table Accessories Price List.

HOW TO ORDER

1. Select Model
2. Select Base
3. Select Edge Style
4. Select Options
5. Select Top Finish
6. Select Edge Finish
7. Select Base Finish

Example: 3054B - TA - PVF -





ACUTE TABLES BOARDROOM



| MODEL | BASES | | TOP SPECIFICATIONS | | | | | | OPTIONS | LBS |
|------------------|-------|------|--------------------|----------|--------------------|-----------------------------|--------------------------------|-----------------------------|---------|-----|
| | Code | Qty. | For Laminate Top | | | For Veneer Top | | | | |
| | | | SE PVF 2MM | HF HB | HBV HBVR HBG | HF2 HB2 HKNR4 HBG2 | HF HB HBV HBVR HBG | HF2 HB2 HKNR4 HBG2 | | |
| <i>Rectangle</i> | | | | | | | | | | |
| 42 x 96RE | T2A | 2 | 2075 | 2985 | 3231 | 3480 | 3848 | 4560 | | 183 |
| 48 x 96RE | T2A | 2 | 2075 | 2985 | 3231 | 3480 | 3848 | 4560 | | 183 |
| 48 x 120RE | T2A | 3 | 2741 | 3916 | 4194 | 4795 | 4883 | 5716 | | 240 |
| 48 x 144RE | T2A | 3 | 3137 | 4822 | 5189 | 5760 | 5624 | 6626 | | 274 |
| 48 x 168RE | T2A | 3 | 3641 | 5337 | 5756 | 6553 | 6369 | 7533 | | 308 |
| 60 x 120RE | T2A | 3 | 3225 | 4982 | 5366 | 5958 | 5817 | 6862 | | 282 |
| 60 x 144RE | T2A | 3 | 3673 | 5782 | 6241 | 6952 | 6784 | 8037 | | 324 |
| 60 x 168RE | T2A | 3 | 4123 | 6582 | 7116 | 7948 | 7751 | 9211 | | 366 |
| <i>Racetrack</i> | | | | | | | | | | |
| 42 x 96RT | T2A | 2 | 2095 | 3124 | 3375 | 3978 | 4404 | 5163 | | 183 |
| 48 x 96RT | T2A | 2 | 2095 | 3124 | 3375 | 3978 | 4404 | 5163 | | 183 |
| 48 x 120RT | T2A | 3 | 2768 | 4400 | 4727 | 5558 | 5523 | 6410 | | 240 |
| 48 x 144RT | T2A | 3 | 3167 | 5200 | 5601 | 6631 | 6392 | 7468 | | 274 |
| 48 x 168RT | T2A | 3 | 3673 | 5884 | 6352 | 7496 | 7274 | 8521 | | 308 |
| 60 x 120RT | T2A | 3 | 3214 | 5254 | 5660 | 6704 | 6657 | 7770 | | 282 |
| 60 x 144RT | T2A | 3 | 3713 | 6254 | 6757 | 8047 | 7746 | 9090 | | 324 |
| 60 x 168RT | T2A | 3 | 4348 | 7113 | 7697 | 9123 | 8847 | 10405 | | 366 |



2448RE-TA (shown with rectangle top)

STANDARD FEATURES

- Select from 15 standard laminates or choose any standard Wilsonart, Nevamar, Formica, Arborite and Pionite matte finish laminates at no upcharge. For other laminate please contact the factory for pricing.
- 9 standard veneer and hardwood edge stains. Stain-to-match available at no upcharge.
- Standard table height 29".
- All bases are standard with floor leveling glides.

OPTIONS

- Custom heights available.
- For applicable Power & Data modules, please see Table Accessories Price List.

HOW TO ORDER

1. Select Model
2. Select Base
3. Select Edge Style
4. Select Top Finish
5. Select Edge Finish
6. Select Base Finish

Example: 4296RE - T2A - PVF





ACUTE TABLES BOARDROOM



| MODEL | BASES | | TOP SPECIFICATIONS | | | | | | OPTIONS | LBS |
|-------------------------------|-------|------|--------------------|----------|--------------------|-----------------------------|--------------------------------|-----------------------------|---------|-----|
| | Code | Qty. | For Laminate Top | | | For Veneer Top | | | | |
| | | | SE PVF 2MM | HF HB | HBV HBVR HBG | HF2 HB2 HKNR4 HBG2 | HF HB HBV HBVR HBG | HF2 HB2 HKNR4 HBG2 | | |
| <i>Boatshape</i> | | | | | | | | | | |
| 42 x 96BT | T2A | 2 | 2095 | 3826 | 4148 | 4480 | 4951 | 5365 | | 183 |
| 48 x 96BT | T2A | 2 | 2095 | 3826 | 4148 | 4480 | 4951 | 5365 | | 183 |
| 48 x 120BT | T2A | 3 | 2768 | 5169 | 5568 | 5990 | 6169 | 6648 | | 240 |
| 48 x 144BT | T2A | 3 | 3167 | 5970 | 6446 | 6952 | 7590 | 8025 | | 274 |
| 48 x 168BT | T2A | 3 | 3673 | 6735 | 7290 | 7874 | 8172 | 8844 | | 308 |
| 60 x 120BT | T2A | 3 | 3214 | 6213 | 6716 | 7242 | 7468 | 8062 | | 282 |
| 60 x 144BT | T2A | 3 | 3713 | 7218 | 7813 | 8446 | 9241 | 9787 | | 324 |
| 60 x 168BT | T2A | 3 | 4348 | 8176 | 8867 | 9598 | 9968 | 10810 | | 366 |
| <i>Boatshape Arc Ends</i> | | | | | | | | | | |
| 42 x 96BTA | T2A | 2 | 2271 | 4377 | 4701 | 5035 | 5503 | 5917 | | 183 |
| 48 x 96BTA | T2A | 2 | 2271 | 4377 | 4701 | 5035 | 5503 | 5917 | | 183 |
| 48 x 120BTA | T2A | 3 | 2943 | 5723 | 6123 | 6545 | 6724 | 7199 | | 240 |
| 48 x 144BTA | T2A | 3 | 3343 | 6521 | 7001 | 7507 | 8141 | 8579 | | 274 |
| 48 x 168BTA | T2A | 3 | 3850 | 7290 | 7845 | 8429 | 8725 | 9400 | | 308 |
| 60 x 120BTA | T2A | 3 | 3435 | 6908 | 7407 | 7934 | 8158 | 8753 | | 282 |
| 60 x 144BTA | T2A | 3 | 3932 | 7907 | 8506 | 9137 | 9933 | 10476 | | 324 |
| 60 x 168BTA | T2A | 3 | 4567 | 8867 | 9559 | 10288 | 10661 | 11505 | | 366 |



2448RE-TA (shown with rectangle top)

STANDARD FEATURES

- Select from 15 standard laminates or choose any standard Wilsonart, Nevamar, Formica, Arborite and Pionite matte finish laminates at no upcharge. For other laminate please contact the factory for pricing.
- 9 standard veneer and hardwood edge stains. Stain-to-match available at no upcharge.
- Standard table height 29".
- All bases are standard with floor leveling glides.

OPTIONS

- Custom heights available.
- For applicable Power & Data modules, please see Table Accessories Price List.

HOW TO ORDER

1. Select Model
2. Select Base
3. Select Edge Style
4. Select Top Finish
5. Select Edge Finish
6. Select Base Finish

Example: 4296BT - T2A - PVF



ANNEX TABLES



PRODUCT CODE

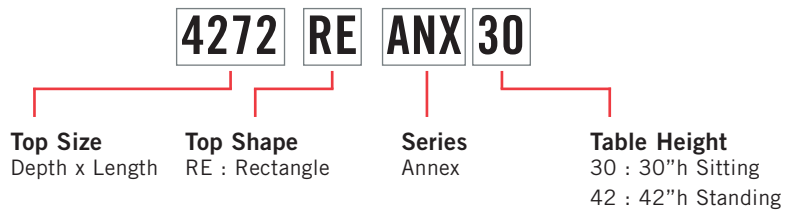

FINISHES

LAMINATE



Select from 15 standard laminates or choose any standard Wilsonart, Nevamar, Formica, Arborite and Pionite matte finish laminates at no upcharge

BASE



Select from one of our 76 standard Spectone colors

EDGE



See Spectone Card or specfurniture.com/materials/finishes for a complete list of finish options and colors.

HOW TO ORDER

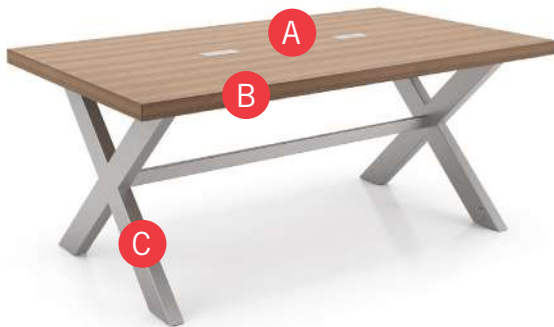

Specify Top Size (Width x Length)

- A** Specify Top Finish
Manufacturer, Laminate Name, Laminate Code
- B** Specify Edge Type and Finish
2mm Bio/2mm PVC Woodgrain/Self Edge
- C** Specify Base Style and Finish
Optional: Power and Data Modules

| Top Size | Top Finish | Edge Type and Finish | Base Style and Finish |
|----------|---------------------------------|--|-----------------------|
| 36 x 72 | Laminate, Arborite, Brown Sugar | Self Edge, Laminate, Arborite, Brown Sugar | ANX42, Silver |



ANNEX TABLES

GENERAL PURPOSE



| MODEL | BASES | TOP SPECIFICATIONS | OPTIONS | LBS |
|-----------------|-------------|--|---------|-----|
| | <i>Code</i> | <i>For Laminate Top</i> SE 2MM | | |
| <i>30" high</i> | | | | |
| 36 X 72RE | ANX30 | 3033 | | 115 |
| 36 X 84RE | ANX30 | 3279 | | 129 |
| 36 X 96RE | ANX30 | 3525 | | 143 |
| 42 X 72RE | ANX30 | 3279 | | 129 |
| 42 X 84RE | ANX30 | 3566 | | 145 |
| 42 X 96RE | ANX30 | 3852 | | 161 |
| <i>42" high</i> | | | | |
| 36 X 72RE | ANX42 | 3163 | | 121 |
| 36 X 84RE | ANX42 | 3409 | | 134 |
| 36 X 96RE | ANX42 | 3655 | | 148 |
| 42 X 72RE | ANX42 | 3409 | | 134 |
| 42 X 84RE | ANX42 | 3696 | | 150 |
| 42 X 96RE | ANX42 | 3982 | | 166 |



STANDARD FEATURES

- 2" built up edge
- Select from 15 standard laminates or choose any standard Wilsonart, Nevamar, Formica, Arborite and Pionite matte finish laminates at no upcharge. For other laminate please contact the factory for pricing.
- Standard with two bases and one stretcher.
- Standard with leveling glides.
- Bases available in any Spectone color.
- Bases are standard with grommets at inside top and inside bottom to feed power through. White grommet will be specified for white bases, black grommet on black bases, and grey grommet for all other Spectone colors.
- Standard 30" or 42" table height, please specify.
- Ships Knocked Down.

OPTIONS

- For applicable Power & Data modules, please see Table Accessories Price List.
- Custom color grommets are available at an upcharge, please contact the factory.
- For veneer finishes or 1-3/4" solid wood top, please contact the factory.

HOW TO ORDER

1. Select Model
2. Select Base
3. Select Edge Style
4. Select Options
5. Select Top Finish
6. Select Edge Finish
7. Select Base Finish

Example: 3684RE - ANX30 - 2MM



ARK TABLES



PRODUCT CODE

2430 RE ARK T

Top Size

Width x Length

Top Shape

- D : Round
- SQ : Square
- RE : Rectangle
- RT : Racetrack
- B : Bullet
- H : Halfmoon
- TP : Trapezoid

- C90 : Crescent
- BT : Boatshape
- BTA : Boatshape Arc

Series

Ark

Base

- X : X-Base
- X4 : 4 Column X-Base
- T : T-Base
- T2 : Double Column T-Base
- C : C-Base
- T2D : T2 with Door



OPTIONS

FLIP TOP



CASTERS



FOLDING



FINISHES

LAMINATE



Select from 15 standard laminates or choose any standard Wilsonart, Nevamar, Formica, Arborite and Pionite matte finish laminates at no upcharge

VENEER

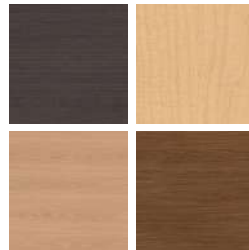

Select from one of our 9 standard wood stains or stain-to-match at no upcharge

BASE



Select from one of our 76 standard Spectone colors

EDGE



See Spectone Card or specfurniture.com/materials/finishes for a complete list of finish options and colors.



ARK TABLES

HOW TO ORDER

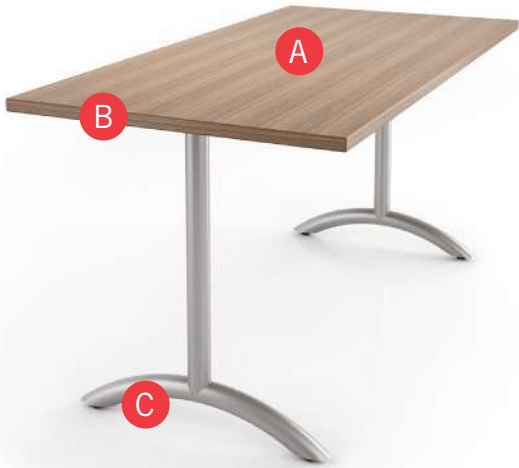

Specify Top Size (Width x Length) and Shape

- A** Specify Top Type and Finish
For Laminate Top: Manufacturer, Laminate Name, Laminate Code
For Veneer Top: Wood Stain
- B** Specify Edge Type, (for hardwood: Style), and Finish
PVC/2mm/Self Edge/Exposed Baltic Birch Plywood/Hardwood
- C** Specify Base Style and Finish

Optional: Flip Top, Fold, Bar Height, Hard Casters, Soft Casters, Wheelbarrow Wheels, Grommets, Seam Connectors, Modesty Panels, Power and Data Modules, Custom Solutions
 Restrictions may apply. See price list tables below for more information.



| Top Size and Shape | Top Type and Finish | Edge Type, Style and Finish | Base Style and Finish |
|--------------------|---------------------------------|--|-----------------------|
| 24 x 72, Rectangle | Laminate, Arborite, Brown Sugar | Hardwood, HF, Custom Brown Sugar Stain | ARKT, Silver |

EDGE PROFILES

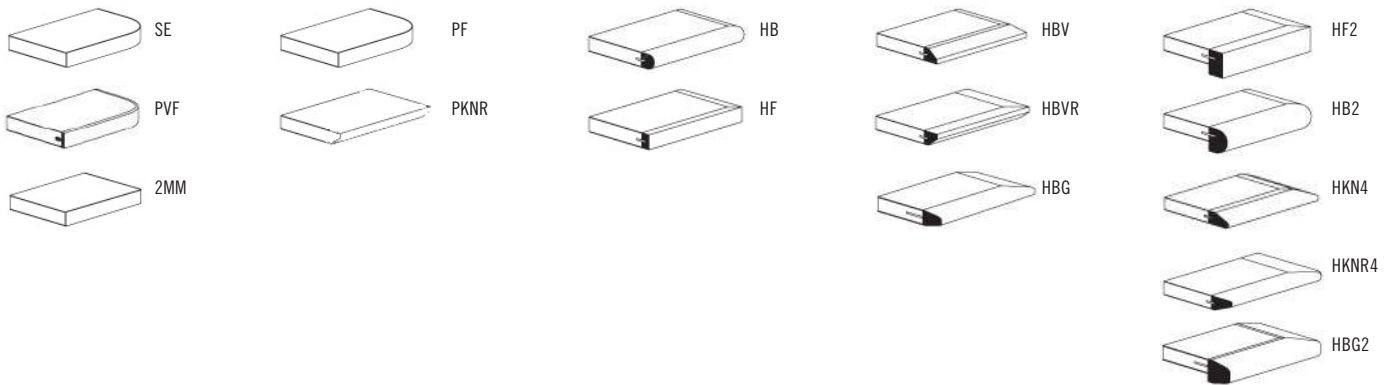



ARK TABLES

GENERAL PURPOSE



| MODEL | BASES | Qty. | TOP SPECIFICATIONS | | | | | | FLIP TOP (FT) | OPTIONS | | LBS | |
|------------------|------------|------|--------------------|--|--------------------|-----------------------------|------------------------|-----------------------------|---------------|------------|-----------|-----------|-----|
| | | | For Laminate Top | | | For Veneer Top | | | | BAR HEIGHT | CASTERS | | |
| Code | | | SE PVF 2MM | HF HB PKNR ¹ PF ¹ | HBV HBVR HBG | HF2 HB2 HKNR4 HBG2 | HF HB HBV HBG | HF2 HB2 HKNR4 HBG2 | | | HARD (HC) | SOFT (SC) | |
| <i>Round</i> | | | | | | | | | | | | | |
| 24D | ARKX | 1 | 581 | 941 | 978 | 1087 | 1146 | 1258 | 154 | 38 | | | 24 |
| 30D | ARKX | 1 | 685 | 1040 | 1087 | 1305 | 1250 | 1414 | 154 | 38 | | | 32 |
| 36D | ARKX | 1 | 784 | 1297 | 1388 | 1566 | 1620 | 1849 | 154 | 38 | 96 | 204 | 41 |
| 42D | ARKX | 1 | 1069 | 1645 | 1769 | 2034 | 2060 | 2373 | 154 | | 96 | 204 | 51 |
| 42D | ARKX4 | 1 | 1250 | 1826 | 1950 | 2215 | 2241 | 2554 | | | 96 | 204 | 75 |
| 48D | ARKX4 | 1 | 1273 | 2046 | 2181 | 2313 | 2787 | 3189 | | | 96 | 204 | 87 |
| 54D | ARKX4 | 1 | 1563 | 2703 | 2913 | 3113 | 3349 | 3865 | | | 96 | 204 | 101 |
| <i>Square</i> | | | | | | | | | | | | | |
| 24x24 SQ | ARKX | 1 | 612 | 807 | 844 | 912 | 962 | 1129 | 154 | 38 | 96 | 204 | 27 |
| 30x30 SQ | ARKX | 1 | 719 | 861 | 912 | 1092 | 1026 | 1258 | 154 | 38 | 96 | 204 | 37 |
| 36x36 SQ | ARKX | 1 | 802 | 1025 | 1087 | 1297 | 1305 | 1505 | 154 | 38 | 96 | 204 | 47 |
| 42x42 SQ | ARKX4 | 1 | 1264 | 1587 | 1686 | 1786 | 1855 | 2128 | | | 96 | 204 | 85 |
| 48x48 SQ | ARKX4 | 1 | 1418 | 1701 | 1806 | 1853 | 2231 | 2584 | | | 96 | 204 | 99 |
| 54x54 SQ | ARKX4 | 1 | 1566 | 2190 | 2354 | 2544 | 2648 | 3105 | | | 96 | 204 | 116 |
| <i>Rectangle</i> | | | | | | | | | | | | | |
| 24x30 RE | ARKX | 1 | 708 | 840 | 889 | 957 | 1010 | 1141 | 154 | | 96 | 204 | 31 |
| 24x30 RE | ARKT, ARKC | 2 | 814 | 946 | 995 | 1063 | 1116 | 1247 | 310 | | 96 | 204 | 39 |
| 24x36 RE | ARKX | 1 | 708 | 840 | 889 | 957 | 1010 | 1141 | 154 | | 96 | 204 | 35 |
| 24x36 RE | ARKT, ARKC | 2 | 814 | 946 | 995 | 1063 | 1116 | 1247 | 310 | | 96 | 204 | 43 |
| 24x42 RE | ARKT, ARKC | 2 | 879 | 1094 | 1150 | 1251 | 1312 | 1493 | 310 | | 96 | 204 | 46 |
| 24x48 RE | ARKT, ARKC | 2 | 879 | 1094 | 1150 | 1251 | 1312 | 1493 | 310 | | 96 | 204 | 50 |

¹Exposed Baltic Birch plywood edge (PKNR, PF) can only be specified on square and rectangle tops up to 47-1/2" x 95-1/2". Clear finish only.



ARK X



ARK X4



ARK T



ARK C

STANDARD FEATURES

- Select from 15 standard laminates or choose any standard Wilsonart, Nevamar, Formica, Arborite and Pionite matte finish laminates at no upcharge. For other laminate please contact the factory for pricing.
- 9 standard veneer and hardwood edge stains. Stain-to-match available at no upcharge.
- Bases available in any Spectone color.
- Standard table height 29".
- All bases are standard with floor leveling glides.
- Locking Casters are not self-leveling.
- Table Carts are available for folding tables. Holds 6 tables.
- Base span increases with size of top.

OPTIONS

- Custom heights available.
- For table accessories, including grommets, seam connectors and modesty panels, go to table accessory price lists.
- For applicable Power & Data modules, please see Table Accessories Price List.

HOW TO ORDER

1. Select Model
2. Select Base
3. Select Edge Style
4. Select Options
5. Select Top Finish
6. Select Edge Finish
7. Select Base Finish

Example: 2424SQ - ARKX - 2MM -

MODEL | BASE | EDGE | OPTIONS



ARK TABLES

GENERAL PURPOSE

| MODEL | BASES | Qty. | TOP SPECIFICATIONS | | | | | | OPTIONS | | | | LBS |
|------------------|------------|------|--------------------|---|--------------|--------------------|---------------|--------------------|---------------|------------|---------|-----|-----------|
| | | | For Laminate Top | | | For Veneer Top | | | FLIP TOP (FT) | FOLD* (FL) | CASTERS | | |
| Code | | | SE PVF 2MM | HF HB PKNR ¹ PF ¹ | HBV HBVR HBG | HF2 HB2 HKNR4 HBG2 | HF HB HBV HBG | HF2 HB2 HKNR4 HBG2 | | | | | HARD (HC) |
| <i>Rectangle</i> | | | | | | | | | | | | | |
| 24x54 RE | ARKT, ARKC | 2 | 940 | 1253 | 1323 | 1439 | 1526 | 1748 | 310 | | 96 | 204 | 53 |
| 24x60 RE | ARKT, ARKC | 2 | 940 | 1253 | 1323 | 1439 | 1526 | 1748 | 310 | 297 | 96 | 204 | 57 |
| 24x66 RE | ARKT, ARKC | 2 | 1088 | 1465 | 1551 | 1693 | 1784 | 2056 | 310 | 297 | 96 | 204 | 61 |
| 24x72 RE | ARKT, ARKC | 2 | 1088 | 1465 | 1551 | 1693 | 1784 | 2056 | 310 | 297 | 96 | 204 | 64 |
| 30x36 RE | ARKX | 2 | 802 | 957 | 1011 | 1100 | 1162 | 1320 | 154 | | 96 | 204 | 41 |
| 30x36 RE | ARKT, ARKC | 2 | 908 | 1063 | 1117 | 1206 | 1268 | 1426 | 310 | | 96 | 204 | 49 |
| 30x42 RE | ARKT, ARKC | 2 | 930 | 1224 | 1291 | 1407 | 1493 | 1713 | 310 | | 96 | 204 | 53 |
| 30x48 RE | ARKT, ARKC | 2 | 930 | 1224 | 1291 | 1407 | 1493 | 1713 | 310 | | 96 | 204 | 58 |
| 30x54 RE | ARKT, ARKC | 2 | 991 | 1391 | 1478 | 1644 | 1742 | 2018 | 310 | | 96 | 204 | 62 |
| 30x60 RE | ARKT, ARKC | 2 | 991 | 1391 | 1478 | 1644 | 1742 | 2018 | 310 | 297 | 96 | 204 | 67 |
| 30x66 RE | ARKT, ARKC | 2 | 1167 | 1492 | 1598 | 1765 | 1861 | 2166 | 310 | 297 | 96 | 204 | 71 |
| 30x72 RE | ARKT, ARKC | 2 | 1225 | 1648 | 1755 | 1971 | 2084 | 2420 | 310 | 297 | 96 | 204 | 76 |
| 30x78 RE | ARKT, ARKC | 2 | 1453 | 1828 | 1955 | 2206 | 2338 | 2724 | 310 | 297 | 96 | 204 | 80 |
| 30x84 RE | ARKT, ARKC | 2 | 1453 | 1828 | 1955 | 2206 | 2338 | 2724 | 310 | 297 | 96 | 204 | 85 |
| 30x90 RE | ARKT, ARKC | 2 | 1475 | 2053 | 2206 | 2438 | 2594 | 3034 | 310 | 297 | 96 | 204 | 89 |
| 30x96 RE | ARKT, ARKC | 2 | 1475 | 2053 | 2206 | 2438 | 2594 | 3034 | 310 | 297 | 96 | 204 | 94 |
| 36x42 RE | ARKT, ARKC | 2 | 1032 | 1253 | 1337 | 1452 | 1542 | 1773 | 310 | | 96 | 204 | 60 |
| 36x48 RE | ARKT, ARKC | 2 | 1057 | 1369 | 1460 | 1598 | 1689 | 1960 | 310 | | 96 | 204 | 66 |
| 36x54 RE | ARKT, ARKC | 2 | 1137 | 1474 | 1578 | 1732 | 1848 | 2144 | 310 | | 96 | 204 | 71 |
| 36x60 RE | ARKT, ARKC | 2 | 1156 | 1590 | 1700 | 1876 | 1987 | 2325 | 310 | | 96 | 204 | 77 |
| 36x66 RE | ARKT, ARKC | 2 | 1246 | 1696 | 1823 | 2016 | 2138 | 2509 | 310 | | 96 | 204 | 82 |
| 36x66 RE | ARKT2 | 2 | 1510 | 1960 | 2087 | 2280 | 2402 | 2773 | | | | | 100 |

*Folding tables available with PVC Flat (PVF) edge only.

¹ Exposed Baltic Birch plywood edge (PKNR, PF) can only be specified on tops up to 47-1/2" x 95-1/2". Clear finish only.



ARK X



ARK T



ARK C

STANDARD FEATURES

- Select from 15 standard laminates or choose any standard Wilsonart, Nevamar, Formica, Arborite and Pionite matte finish laminates at no upcharge. For other laminate please contact the factory for pricing.
- 9 standard veneer and hardwood edge stains. Stain-to-match available at no upcharge.
- Bases available in any Spectone color.
- Standard table height 29".
- All bases are standard with floor leveling glides.
- Locking Casters are not self-leveling.
- Table Carts are available for folding tables. Holds 6 tables.
- Base span increases with size of top.

OPTIONS

- Custom heights available.
- For table accessories, including grommets, seam connectors and modesty panels, go to table accessory price lists.
- For applicable Power & Data modules, please see Table Accessories Price List.

HOW TO ORDER

1. Select Model
2. Select Base
3. Select Edge Style
4. Select Options
5. Select Top Finish
6. Select Edge Finish
7. Select Base Finish

Example: 3084RE - ARKT - 2MM -





ARK TABLES

GENERAL PURPOSE

| MODEL | BASES | Qty. | TOP SPECIFICATIONS | | | | | | OPTIONS | | | | LBS |
|------------------|------------|------|--------------------|---|--------------|-------------------|---------------|-------------------|---------------|------------|---------|-----|-----------|
| | | | For Laminate Top | | | For Veneer Top | | | FLIP TOP (FT) | FOLD* (FL) | CASTERS | | |
| Code | | | SE PVF 2MM | HF HB PKNR ¹ PF ¹ | HBV HBVR HBG | HF2 HB2 HKN4 HBG2 | HF HB HBV HBG | HF2 HB2 HKN4 HBG2 | | | | | HARD (HC) |
| <i>Rectangle</i> | | | | | | | | | | | | | |
| 36x72 RE | ARKT, ARKC | 2 | 1285 | 1755 | 1876 | 2155 | 2291 | 2692 | 310 | 297 | 96 | 204 | 87 |
| 36x72 RE | ARKT2 | 2 | 1549 | 2019 | 2140 | 2419 | 2555 | 2956 | | | | | 105 |
| 36x78 RE | ARKT, ARKC | 2 | 1626 | 2129 | 2287 | 2530 | 2688 | 3161 | 310 | 297 | 96 | 204 | 93 |
| 36x78 RE | ARKT2 | 2 | 1890 | 2393 | 2551 | 2794 | 2952 | 3425 | | | | | 111 |
| 36x84 RE | ARKT, ARKC | 2 | 1626 | 2129 | 2287 | 2530 | 2688 | 3161 | 310 | 297 | 96 | 204 | 98 |
| 36x84 RE | ARKT2 | 2 | 1890 | 2393 | 2551 | 2794 | 2952 | 3425 | | | | | 116 |
| 36x90 RE | ARKT, ARKC | 2 | 1633 | 2350 | 2530 | 2813 | 2995 | 3519 | 310 | 297 | 96 | 204 | 104 |
| 36x90 RE | ARKT2 | 2 | 1897 | 2614 | 2794 | 3077 | 3259 | 3783 | | | | | 122 |
| 36x96 RE | ARKT, ARKC | 2 | 1633 | 2350 | 2530 | 2813 | 2995 | 3519 | 310 | 297 | 96 | 204 | 109 |
| 36x96 RE | ARKT2 | 2 | 1897 | 2614 | 2794 | 3077 | 3259 | 3783 | | | | | 127 |
| 42x78 RE | ARKT2 | 2 | 2138 | 2570 | 2743 | 3161 | 3298 | 3846 | | | | | 123 |
| 42x84 RE | ARKT2 | 2 | 2138 | 2570 | 2743 | 3161 | 3298 | 3846 | | | | | 130 |

*Folding tables available with PVC Flat (PVF) edge only.

¹ Exposed Baltic Birch plywood edge (PKNR, PF) can only be specified on tops up to 47-1/2" x 95-1/2". Clear finish only.



STANDARD FEATURES

- Select from 15 standard laminates or choose any standard Wilsonart, Nevamar, Formica, Arborite and Pionite matte finish laminates at no upcharge. For other laminate please contact the factory for pricing.
- 9 standard veneer and hardwood edge stains. Stain-to-match available at no upcharge.
- Bases available in any Spectone color.
- Standard table height 29".
- All bases are standard with floor leveling glides.
- Locking Casters are not self-leveling.
- Table Carts are available for folding tables. Holds 6 tables.
- Base span increases with size of top.

OPTIONS

- Custom heights available.
- For table accessories, including grommets, seam connectors and modesty panels, go to table accessory price lists.
- For applicable Power & Data modules, please see Table Accessories Price List.

HOW TO ORDER

1. Select Model
2. Select Base
3. Select Edge Style
4. Select Options
5. Select Top Finish
6. Select Edge Finish
7. Select Base Finish

Example: 3690RE - ARKT2 - 2MM -
 MODEL BASE EDGE OPTIONS



ARK TABLES

GENERAL PURPOSE

| MODEL | BASES | Qty. | TOP SPECIFICATIONS | | | | | | OPTIONS | | | LBS |
|------------------|------------|------|--------------------|-------|--------------|---------------------|---------------------|-----------|---------------|-----------|-----|-----|
| | | | For Laminate Top | | | For Veneer Top | | | FLIP TOP (FT) | CASTERS | | |
| | | | SE PVF 2MM | HF HB | HBV HBVR HBG | HF HB HB2 HKN4 HBG2 | HF HB HB2 HKN4 HBG2 | HARD (HC) | | SOFT (SC) | | |
| <i>Racetrack</i> | | | | | | | | | | | | |
| 36x54 RT | ARKT, ARKC | 2 | 1213 | 1784 | 1917 | 2155 | 2253 | 2602 | 310 | 96 | 204 | 64 |
| 36x54 RT | ARKT2 | 2 | 1477 | 2048 | 2181 | 2419 | 2517 | 2866 | | | | 82 |
| 36x60 RT | ARKT, ARKC | 2 | 1213 | 1784 | 1917 | 2155 | 2253 | 2602 | 310 | 96 | 204 | 70 |
| 36x60 RT | ARKT2 | 2 | 1477 | 2048 | 2181 | 2419 | 2517 | 2866 | | | | 88 |
| 36x66 RT | ARKT, ARKC | 2 | 1374 | 1971 | 2115 | 2370 | 2594 | 3030 | 310 | 96 | 204 | 75 |
| 36x66 RT | ARKT2 | 2 | 1638 | 2235 | 2379 | 2634 | 2858 | 3294 | | | | 93 |
| 36x72 RT | ARKT, ARKC | 2 | 1374 | 1971 | 2115 | 2370 | 2594 | 3030 | 310 | 96 | 204 | 80 |
| 36x72 RT | ARKT2 | 2 | 1638 | 2235 | 2379 | 2634 | 2858 | 3294 | | | | 98 |
| 36x78 RT | ARKT, ARKC | 2 | 1644 | 2402 | 2579 | 2964 | 3045 | 3553 | 310 | 96 | 204 | 86 |
| 36x78 RT | ARKT2 | 2 | 1908 | 2666 | 2843 | 3228 | 3309 | 3817 | | | | 104 |
| 36x84 RT | ARKT, ARKC | 2 | 1644 | 2402 | 2579 | 2964 | 3045 | 3553 | 310 | 96 | 204 | 91 |
| 36x84 RT | ARKT2 | 2 | 1908 | 2666 | 2843 | 3228 | 3309 | 3817 | | | | 109 |
| 36x90 RT | ARKT, ARKC | 2 | 1648 | 2659 | 2870 | 3301 | 3402 | 3981 | 310 | 96 | 204 | 97 |
| 36x90 RT | ARKT2 | 2 | 1912 | 2923 | 3134 | 3565 | 3666 | 4245 | | | | 115 |
| 36x96 RT | ARKT, ARKC | 2 | 1648 | 2659 | 2870 | 3301 | 3402 | 3981 | 310 | 96 | 204 | 102 |
| 36x96 RT | ARKT2 | 2 | 1912 | 2923 | 3134 | 3565 | 3666 | 4245 | | | | 120 |
| 42x78 RT | ARKT2 | 2 | 2153 | 2870 | 3087 | 3523 | 3628 | 4212 | | | | 114 |
| 42x84 RT | ARKT2 | 2 | 2153 | 2870 | 3087 | 3523 | 3628 | 4212 | | | | 120 |
| 48x78 RT | ARKT2 | 2 | 2156 | 3178 | 3424 | 3810 | 4051 | 4715 | | | | 123 |
| 48x84 RT | ARKT2 | 2 | 2156 | 3178 | 3424 | 3810 | 4051 | 4715 | | | | 130 |



STANDARD FEATURES

- Select from 15 standard laminates or choose any standard Wilsonart, Nevamar, Formica, Arborite and Pionite matte finish laminates at no upcharge. For other laminate please contact the factory for pricing.
- 9 standard veneer and hardwood edge stains. Stain-to-match available at no upcharge.
- Bases available in any Spectone color.
- Standard table height 29".
- All bases are standard with floor leveling glides.
- Locking Casters are not self-leveling.
- Table Carts are available for folding tables. Holds 6 tables.
- Base span increases with size of top.

OPTIONS

- Custom heights available.
- For table accessories, including grommets, seam connectors and modesty panels, go to table accessory price lists.
- For applicable Power & Data modules, please see Table Accessories Price List.

HOW TO ORDER

1. Select Model
2. Select Base
3. Select Edge Style
4. Select Options
5. Select Top Finish
6. Select Edge Finish
7. Select Base Finish

Example: 3690RT - ARKT2 - 2MM -

MODEL | BASE | EDGE | OPTIONS



BACK TO CONTENTS

ARK TABLES

GENERAL PURPOSE



| MODEL | | BASES | TOP SPECIFICATIONS | | | | | | OPTIONS | | | LBS |
|-----------------------------|------|------------|--------------------|-------|--------------|--------------------|---------------|--------------------|---------------|-----------|-----------|-----|
| Code | Qty. | | For Laminate Top | | | For Veneer Top | | | FLIP TOP (FT) | CASTERS | | |
| | | | SE PVF 2MM | HF HB | HBV HBVR HBG | HF2 HB2 HKNR4 HBG2 | HF HB HBV HBG | HF2 HB2 HKNR4 HBG2 | | HARD (HC) | SOFT (SC) | |
| <i>Bullet</i> | | | | | | | | | | | | |
| 30x54 B | 2 | ARKT, ARKC | 1112 | 1681 | 1800 | 2008 | 2070 | 2414 | 310 | 96 | 204 | 60 |
| 30x60 B | 2 | ARKT, ARKC | 1112 | 1681 | 1800 | 2008 | 2070 | 2414 | 310 | 96 | 204 | 64 |
| 36x54 B | 2 | ARKT, ARKC | 1235 | 2192 | 2361 | 2666 | 2708 | 3141 | 310 | 96 | 204 | 68 |
| 36x60 B | 2 | ARKT, ARKC | 1235 | 2192 | 2361 | 2666 | 2708 | 3141 | 310 | 96 | 204 | 73 |
| 36x66 B | 2 | ARKT, ARKC | 1373 | 2431 | 2618 | 2944 | 3133 | 3677 | 310 | 96 | 204 | 78 |
| 36x72 B | 2 | ARKT, ARKC | 1373 | 2431 | 2618 | 2944 | 3133 | 3677 | 310 | 96 | 204 | 84 |
| <i>Halfmoon</i> | | | | | | | | | | | | |
| 24x48 H | 2 | ARKT, ARKC | 897 | 1411 | 1540 | 1696 | 1823 | 2115 | 310 | 96 | 204 | 44 |
| 30x60 H | 2 | ARKT, ARKC | 1112 | 1877 | 2054 | 2230 | 2450 | 2867 | 310 | 96 | 204 | 57 |
| 36x72 H | 2 | ARKT, ARKC | 1373 | 2417 | 2648 | 2864 | 3221 | 3785 | 310 | 96 | 204 | 73 |
| <i>Trapezoid</i> | | | | | | | | | | | | |
| 30x60 TP | 2 | ARKT, ARKC | 1112 | 1583 | 1693 | 1882 | 1937 | 2256 | 310 | 96 | 204 | 63 |
| 36x72 TP | 2 | ARKT, ARKC | 1373 | 2012 | 2156 | 2484 | 2566 | 3026 | 310 | 96 | 204 | 82 |
| <i>Crescent (connector)</i> | | | | | | | | | | | | |
| 30x36 CRC90 | 2 | ARKT, ARKC | 1087 | 1773 | 1860 | 1928 | 2146 | 2385 | | | | 47 |
| 36x42 CRC90 | 2 | ARKT, ARKC | 1450 | 2094 | 2213 | 2302 | 2602 | 2926 | | | | 58 |



STANDARD FEATURES

- Select from 15 standard laminates or choose any standard Wilsonart, Nevamar, Formica, Arborite and Pionite matte finish laminates at no upcharge. For other laminate please contact the factory for pricing.
- 9 standard veneer and hardwood edge stains. Stain-to-match available at no upcharge.
- Bases available in any Spectone color.
- Standard table height 29".
- All bases are standard with floor leveling glides.
- Locking Casters are not self-leveling.
- Table Carts are available for folding tables. Holds 6 tables.
- Base span increases with size of top.

OPTIONS

- Custom heights available.
- For table accessories, including grommets, seam connectors and modesty panels, go to table accessory price lists.
- For applicable Power & Data modules, please see Table Accessories Price List.

HOW TO ORDER

1. Select Model
2. Select Base
3. Select Edge Style
4. Select Options
5. Select Top Finish
6. Select Edge Finish
7. Select Base Finish

Example: 3672B - ARKT - 2MM - [] [] [] []

MODEL BASE EDGE OPTIONS



ARK TABLES BOARDROOM



| MODEL | | BASES | | TOP SPECIFICATIONS | | | | | | OPTIONS | LBS |
|------------------|--------|-------------|--|-------------------------|----------|--------------------|-------------------------------------|--------------------------------|-------------------------------------|---------|-----|
| <i>Code</i> | | <i>Qty.</i> | | <i>For Laminate Top</i> | | | <i>For Veneer Top</i> | | | | |
| | | | | SE PVF 2MM | HF HB | HBV HBVR HBG | HF2 HB2 HKN4 HKNR4 HBG2 | HF HB HBV HBVR HBG | HF2 HB2 HKN4 HKNR4 HBG2 | | |
| <i>Rectangle</i> | | | | | | | | | | | |
| 42x96 RE | ARKT2 | 2 | | 2191 | 3101 | 3347 | 3596 | 3964 | 4676 | | 141 |
| 42x96 RE | ARKT2D | 2 | | 3353 | 4263 | 4509 | 4758 | 5126 | 5838 | | 149 |
| 48x96 RE | ARKT2 | 2 | | 2191 | 3101 | 3347 | 3596 | 3964 | 4676 | | 157 |
| 48x96 RE | ARKT2D | 2 | | 3353 | 4263 | 4509 | 4758 | 5126 | 5838 | | 165 |
| 48x120 RE | ARKT2 | 3 | | 2915 | 4090 | 4368 | 4969 | 5057 | 5890 | | 206 |
| 48x120 RE | ARKT2D | 3 | | 4658 | 5833 | 6111 | 6712 | 6800 | 7633 | | 218 |
| 48x144 RE | ARKT2 | 3 | | 3311 | 4996 | 5363 | 5934 | 5798 | 6800 | | 235 |
| 48x144 RE | ARKT2D | 3 | | 5054 | 6739 | 7106 | 7677 | 7541 | 8543 | | 247 |
| 48x168 RE | ARKT2 | 3 | | 3815 | 5511 | 5930 | 6727 | 6543 | 7707 | | 264 |
| 48x168 RE | ARKT2D | 3 | | 5558 | 7254 | 7673 | 8470 | 8286 | 9450 | | 276 |
| 60x120 RE | ARKT2 | 3 | | 3399 | 5156 | 5540 | 6132 | 5991 | 7036 | | 242 |
| 60x120 RE | ARKT2D | 3 | | 5142 | 6899 | 7283 | 7875 | 7734 | 8779 | | 254 |
| 60x144 RE | ARKT2 | 3 | | 3847 | 5956 | 6415 | 7126 | 6958 | 8211 | | 278 |
| 60x144 RE | ARKT2D | 3 | | 5590 | 7699 | 8158 | 8869 | 8701 | 9954 | | 290 |
| 60x168 RE | ARKT2 | 3 | | 4297 | 6756 | 7290 | 8122 | 7925 | 9385 | | 314 |
| 60x168 RE | ARKT2D | 3 | | 6040 | 8499 | 9033 | 9865 | 9668 | 11128 | | 326 |



ARKT2



ARKT2D

STANDARD FEATURES

- Select from 15 standard laminates or choose any standard Wilsonart, Nevamar, Formica, Arborite and Pionite matte finish laminates at no upcharge. For other laminate please contact the factory for pricing.
- 9 standard veneer and hardwood edge stains. Stain-to-match available at no upcharge.
- Bases available in any Spectone color.
- Standard table height 29".
- All bases are standard with floor leveling glides.

OPTIONS

- Custom heights available.
- For table accessories, including grommets, seam connectors and modesty panels, go to table accessory price lists.
- For applicable Power & Data modules, please see Table Accessories Price List.

HOW TO ORDER

1. Select Model
2. Select Base
3. Select Edge Style
4. Select Options
5. Select Top Finish
6. Select Edge Finish
7. Select Base Finish

Example: 4296RE - ARKT2 - 2MM -





ARK TABLES BOARDROOM



| MODEL | BASES | | TOP SPECIFICATIONS | | | | | | OPTIONS | LBS |
|------------------|--------|------|--------------------|----------|--------------------|-------------------------------------|--------------------------------|-------------------------------------|---------|-----|
| | Code | Qty. | For Laminate Top | | | For Veneer Top | | | | |
| | | | SE PVF 2MM | HF HB | HBV HBVR HBG | HF2 HB2 HKN4 HKNR4 HBG2 | HF HB HBV HBVR HBG | HF2 HB2 HKN4 HKNR4 HBG2 | | |
| <i>Racetrack</i> | | | | | | | | | | |
| 42x96 RT | ARKT2 | 2 | 2211 | 3240 | 3491 | 4094 | 4520 | 5279 | | 132 |
| 42x96 RT | ARKT2D | 2 | 3373 | 4402 | 4653 | 5256 | 5682 | 6441 | | 140 |
| 48x96 RT | ARKT2 | 2 | 2211 | 3240 | 3491 | 4094 | 4520 | 5279 | | 144 |
| 48x96 RT | ARKT2D | 2 | 3373 | 4402 | 4653 | 5256 | 5682 | 6441 | | 152 |
| 48x120 RT | ARKT2 | 3 | 2942 | 4574 | 4901 | 5732 | 5697 | 6584 | | 194 |
| 48x120 RT | ARKT2D | 3 | 4685 | 6317 | 6644 | 7475 | 7440 | 8327 | | 206 |
| 48x144 RT | ARKT2 | 3 | 3341 | 5374 | 5775 | 6805 | 6566 | 7642 | | 223 |
| 48x144 RT | ARKT2D | 3 | 5084 | 7117 | 7518 | 8548 | 8309 | 9385 | | 235 |
| 48x168 RT | ARKT2 | 3 | 3847 | 6058 | 6526 | 7670 | 7448 | 8695 | | 251 |
| 48x168 RT | ARKT2D | 3 | 5590 | 7801 | 8269 | 9413 | 9191 | 10438 | | 263 |
| 60x120 RT | ARKT2 | 3 | 3388 | 5428 | 5834 | 6878 | 6831 | 7944 | | 223 |
| 60x120 RT | ARKT2D | 3 | 5131 | 7171 | 7577 | 8621 | 8574 | 9687 | | 235 |
| 60x144 RT | ARKT2 | 3 | 3887 | 6428 | 6931 | 8221 | 7920 | 9264 | | 259 |
| 60x144 RT | ARKT2D | 3 | 5630 | 8171 | 8674 | 9964 | 9663 | 11007 | | 271 |
| 60x168 RT | ARKT2 | 3 | 4522 | 7287 | 7871 | 9297 | 9021 | 10579 | | 295 |
| 60x168 RT | ARKT2D | 3 | 6265 | 9030 | 9614 | 11040 | 10764 | 12322 | | 307 |



ARKT2



ARKT2D

STANDARD FEATURES

- Select from 15 standard laminates or choose any standard Wilsonart, Nevamar, Formica, Arborite and Pionite matte finish laminates at no upcharge. For other laminate please contact the factory for pricing.
- 9 standard veneer and hardwood edge stains. Stain-to-match available at no upcharge.
- Bases available in any Spectone color.
- Standard table height 29".
- All bases are standard with floor leveling glides.

OPTIONS

- Custom heights available.
- For table accessories, including grommets, seam connectors and modesty panels, go to table accessory price lists.
- For applicable Power & Data modules, please see Table Accessories Price List.

HOW TO ORDER

1. Select Model
2. Select Base
3. Select Edge Style
4. Select Options
5. Select Top Finish
6. Select Edge Finish
7. Select Base Finish

Example: 4296RT - ARKT2 - 2MM -





ARK TABLES BOARDROOM



| MODEL | | BASES | TOP SPECIFICATIONS | | | | | | OPTIONS | LBS |
|------------------|--------|-------------|-------------------------|----------|--------------------|-------------------------------------|--------------------------------|-------------------------------------|---------|-----|
| <i>Code</i> | | <i>Qty.</i> | <i>For Laminate Top</i> | | | <i>For Veneer Top</i> | | | | |
| | | | SE PVF 2MM | HF HB | HBV HBVR HBG | HF2 HB2 HKN4 HKNR4 HBG2 | HF HB HBV HBVR HBG | HF2 HB2 HKN4 HKNR4 HBG2 | | |
| <i>Boatshape</i> | | | | | | | | | | |
| 42x96 BT | ARKT2 | 2 | 2211 | 3942 | 4264 | 4596 | 5067 | 5481 | | 132 |
| 42x96 BT | ARKT2D | 2 | 3373 | 5104 | 5426 | 5758 | 6229 | 6643 | | 140 |
| 48x96 BT | ARKT2 | 2 | 2211 | 3942 | 4264 | 4596 | 5067 | 5481 | | 147 |
| 48x96 BT | ARKT2D | 2 | 3373 | 5104 | 5426 | 5758 | 6229 | 6643 | | 155 |
| 48x120 BT | ARKT2 | 3 | 2942 | 5343 | 5742 | 6164 | 6343 | 6822 | | 194 |
| 48x120 BT | ARKT2D | 3 | 4685 | 7086 | 7485 | 7907 | 8086 | 8565 | | 206 |
| 48x144 BT | ARKT2 | 3 | 3341 | 6144 | 6620 | 7126 | 7764 | 8199 | | 221 |
| 48x144 BT | ARKT2D | 3 | 5084 | 7887 | 8363 | 8869 | 9507 | 9942 | | 233 |
| 48x168 BT | ARKT2 | 3 | 3847 | 6909 | 7464 | 8048 | 8346 | 9018 | | 247 |
| 48x168 BT | ARKT2D | 3 | 5590 | 8652 | 9207 | 9791 | 10089 | 10761 | | 259 |
| 60x120 BT | ARKT2 | 3 | 3388 | 6387 | 6890 | 7416 | 7642 | 8236 | | 230 |
| 60x120 BT | ARKT2D | 3 | 5131 | 8130 | 8633 | 9159 | 9385 | 9979 | | 242 |
| 60x144 BT | ARKT2 | 3 | 3887 | 7392 | 7987 | 8620 | 9415 | 9961 | | 264 |
| 60x144 BT | ARKT2D | 3 | 5630 | 9135 | 9730 | 10363 | 11158 | 11704 | | 276 |
| 60x168 BT | ARKT2 | 3 | 4522 | 8350 | 9041 | 9772 | 10142 | 10984 | | 298 |
| 60x168 BT | ARKT2D | 3 | 6265 | 10093 | 10784 | 11515 | 11885 | 12727 | | 310 |



ARKT2



ARKT2D

STANDARD FEATURES

- Select from 15 standard laminates or choose any standard Wilsonart, Nevamar, Formica, Arborite and Pionite matte finish laminates at no upcharge. For other laminate please contact the factory for pricing.
- 9 standard veneer and hardwood edge stains. Stain-to-match available at no upcharge.
- Bases available in any Spectone color.
- Standard table height 29".
- All bases are standard with floor leveling glides.

OPTIONS

- Custom heights available.
- For table accessories, including grommets, seam connectors and modesty panels, go to table accessory price lists.
- For applicable Power & Data modules, please see Table Accessories Price List.

HOW TO ORDER

1. Select Model
2. Select Base
3. Select Edge Style
4. Select Options
5. Select Top Finish
6. Select Edge Finish
7. Select Base Finish

Example: 4296BT - ARKT2 - 2MM -





ARK TABLES BOARDROOM



| MODEL | | BASES | TOP SPECIFICATIONS | | | | | | OPTIONS | LBS |
|---------------------------|--------|-------------|-------------------------|----------|--------------------|-------------------------------------|--------------------------------|-------------------------------------|---------|-----|
| <i>Code</i> | | <i>Qty.</i> | <i>For Laminate Top</i> | | | <i>For Veneer Top</i> | | | | |
| | | | SE PVF 2MM | HF HB | HBV HBVR HBG | HF2 HB2 HKN4 HKNR4 HBG2 | HF HB HBV HBVR HBG | HF2 HB2 HKN4 HKNR4 HBG2 | | |
| <i>Boatshape Arc Ends</i> | | | | | | | | | | |
| 42x96 BTA | ARKT2 | 2 | 2387 | 4493 | 4817 | 5151 | 5619 | 6033 | | 129 |
| 42x96 BTA | ARKT2D | 2 | 3549 | 5655 | 5979 | 6313 | 6781 | 7195 | | 137 |
| 48x96 BTA | ARKT2 | 2 | 2387 | 4493 | 4817 | 5151 | 5619 | 6033 | | 144 |
| 48x96 BTA | ARKT2D | 2 | 3549 | 5655 | 5979 | 6313 | 6781 | 7195 | | 152 |
| 48x120 BTA | ARKT2 | 3 | 3117 | 5897 | 6297 | 6719 | 6898 | 7373 | | 191 |
| 48x120 BTA | ARKT2D | 3 | 4860 | 7640 | 8040 | 8462 | 8641 | 9116 | | 203 |
| 48x144 BTA | ARKT2 | 3 | 3517 | 6695 | 7175 | 7681 | 8315 | 8753 | | 218 |
| 48x144 BTA | ARKT2D | 3 | 5260 | 8438 | 8918 | 9424 | 10058 | 10496 | | 230 |
| 48x168 BTA | ARKT2 | 3 | 4024 | 7464 | 8019 | 8603 | 8899 | 9574 | | 245 |
| 48x168 BTA | ARKT2D | 3 | 5767 | 9207 | 9762 | 10346 | 10642 | 11317 | | 257 |
| 60x120 BTA | ARKT2 | 3 | 3609 | 7082 | 7581 | 8108 | 8332 | 8927 | | 227 |
| 60x120 BTA | ARKT2D | 3 | 5352 | 8825 | 9324 | 9851 | 10075 | 10670 | | 239 |
| 60x144 BTA | ARKT2 | 3 | 4106 | 8081 | 8680 | 9311 | 10107 | 10650 | | 260 |
| 60x144 BTA | ARKT2D | 3 | 5849 | 9824 | 10423 | 11054 | 11850 | 12393 | | 272 |
| 60x168 BTA | ARKT2 | 3 | 4741 | 9041 | 9733 | 10462 | 10835 | 11679 | | 295 |
| 60x168 BTA | ARKT2D | 3 | 6484 | 10784 | 11476 | 12205 | 12578 | 13422 | | 307 |



ARKT2



ARKT2D

STANDARD FEATURES

- Select from 15 standard laminates or choose any standard Wilsonart, Nevamar, Formica, Arborite and Pionite matte finish laminates at no upcharge. For other laminate please contact the factory for pricing.
- 9 standard veneer and hardwood edge stains. Stain-to-match available at no upcharge.
- Bases available in any Spectone color.
- Standard table height 29".
- All bases are standard with floor leveling glides.

OPTIONS

- Custom heights available.
- For table accessories, including grommets, seam connectors and modesty panels, go to table accessory price lists.
- For applicable Power & Data modules, please see Table Accessories Price List.

HOW TO ORDER

1. Select Model
2. Select Base
3. Select Edge Style
4. Select Options
5. Select Top Finish
6. Select Edge Finish
7. Select Base Finish

Example: 4296BTA - ARKT2 - 2MM -





ASKEW TABLES



PRODUCT CODE

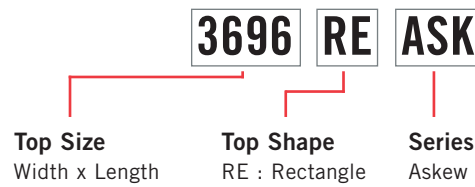

FINISHES

LAMINATE



Select from 15 standard laminates or choose any standard Wilsonart, Nevamar, Formica, Arborite and Pionite matte finish laminates at no upcharge

VENEER

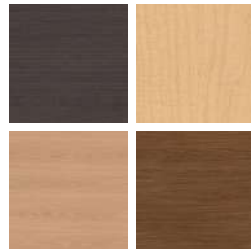

Select from one of our 9 standard wood stains or stain-to-match at no upcharge

BASE



Select from one of our 76 standard Spectone colors

EDGE



See Spectone Card or specfurniture.com/materials/finishes for a complete list of finish options and colors.



ASKEW TABLES

HOW TO ORDER



Specify Top Size (Width x Length) and Shape

- A** Specify Top Type and Finish
For Laminate Top: Manufacturer, Laminate Name & Code
For Veneer Top: Wood Stain
- B** Specify Edge Type, (for hardwood: Style), and Finish
PVC/2mm/Self Edge/Exposed Baltic Birch Plywood/Hardwood
- C** Specify Base Style and Finish
 Optional: Power and Data Modules, Wire Management Solutions, Custom Solutions

| Top Size and Shape | Top Type and Finish | Edge Type and Finish | Base Style and Finish |
|--------------------|---------------------------------|--|-----------------------|
| 36 x 96, Rectangle | Laminate, Arborite, Brown Sugar | Hardwood, HF, Custom Brown Sugar Stain | ASK, Silver |



EDGE PROFILES

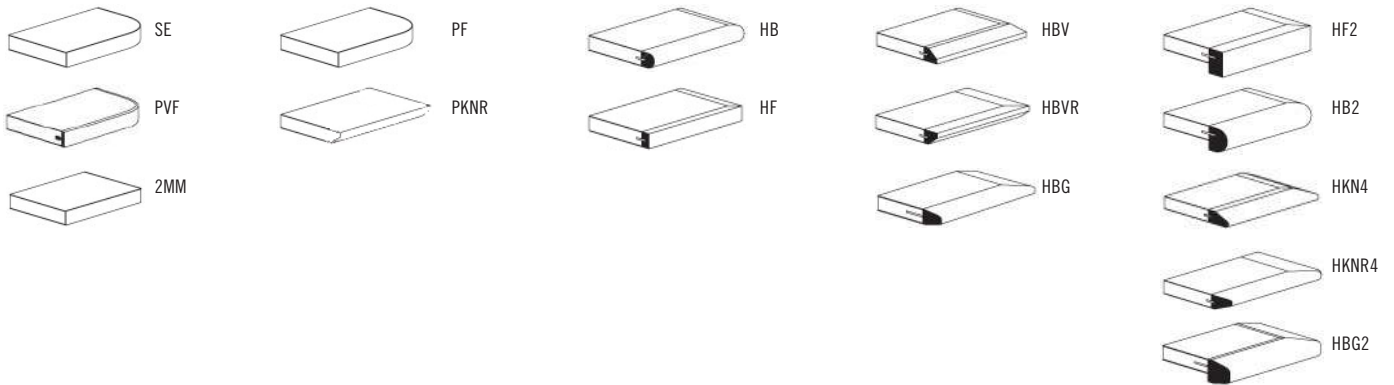



ASKEW TABLES BOARDROOM

| MODEL | TABLETOPS <i>Number of Sections</i> | BASES | | TOP SPECIFICATIONS | | | | | | LBS |
|------------------|--|-------------|-------------|-------------------------|--|--------------------|-------------------------------------|--------------------------------|-------------------------------------|-----|
| | | <i>Code</i> | <i>Qty.</i> | <i>For Laminate Top</i> | | | <i>For Veneer Top</i> | | | |
| | | | | SE PVF 2MM | HF HB PKNR ¹ PF ¹ | HBV HBVR HBG | HF2 HB2 HKN4 HKNR4 HBG2 | HF HB HBV HBVR HBG | HF2 HB2 HKN4 HKNR4 HBG2 | |
| <i>Rectangle</i> | | | | | | | | | | |
| 36 X 96RE | 1 | ASK | 2 | 3309 | 4026 | 4206 | 4489 | 4671 | 5195 | 139 |
| 36 X 108RE | 1 | ASK | 2 | 3442 | 4116 | 4324 | 4632 | 4863 | 5456 | 152 |
| 36 X 120RE | 2 | ASK | 2 | 3480 | 4347 | 4568 | 4919 | 5142 | 5818 | 165 |
| 36 X 144RE | 2 | ASK | 3 | 4830 | 5770 | 6011 | 6571 | 6841 | 7644 | 198 |
| 36 X 168RE | 2 | ASK | 3 | 5296 | 6518 | 6832 | 7559 | 7910 | 8954 | 221 |
| 36 X 192RE | 2 | ASK | 3 | 5527 | 6960 | 7320 | 7885 | 8249 | 9298 | 245 |
| 36 X 216RE | 2 | ASK | 3 | 5793 | 7141 | 7557 | 8172 | 8634 | 9820 | 268 |
| 42 X 96RE | 1 | ASK | 2 | 3603 | 4513 | 4759 | 5008 | 5376 | 6088 | 154 |
| 42 X 108RE | 1 | ASK | 2 | 3797 | 4890 | 5149 | 5708 | 5790 | 6564 | 168 |
| 42 X 120RE | 2 | ASK | 2 | 3920 | 5095 | 5374 | 5974 | 6062 | 6895 | 183 |
| 42 X 144RE | 2 | ASK | 3 | 5408 | 7093 | 7460 | 8031 | 7896 | 8897 | 219 |
| 42 X 168RE | 2 | ASK | 3 | 5912 | 7609 | 8027 | 8824 | 8640 | 9804 | 246 |
| 42 X 192RE | 2 | ASK | 3 | 6235 | 8444 | 8952 | 10089 | 9701 | 11094 | 274 |
| 42 X 216RE | 2 | ASK | 3 | 6853 | 9040 | 9599 | 10809 | 10441 | 12010 | 301 |
| 48 X 96RE | 1 | ASK | 2 | 3603 | 4513 | 4759 | 5008 | 5376 | 6088 | 168 |
| 48 X 108RE | 1 | ASK | 2 | 3818 | 4911 | 5170 | 5728 | 5810 | 6585 | 185 |
| 48 X 120RE | 2 | ASK | 2 | 3941 | 5116 | 5394 | 5995 | 6083 | 6916 | 201 |
| 48 X 144RE | 2 | ASK | 3 | 5429 | 7114 | 7481 | 8052 | 7916 | 8918 | 241 |
| 48 X 168RE | 2 | ASK | 3 | 5933 | 7629 | 8048 | 8845 | 8661 | 9825 | 272 |
| 48 X 192RE | 2 | ASK | 3 | 6256 | 8465 | 8973 | 10110 | 9722 | 11114 | 302 |
| 48 X 216RE | 2 | ASK | 3 | 6873 | 9060 | 9620 | 10830 | 10461 | 12031 | 333 |



¹ Exposed Baltic Birch plywood edge (PKNR, PF) can only be specified on square tops up to 47-1/2" x 95-1/2". Clear finish only.



3696 RE ASK



48144 RE ASK



WIRE MANAGER

STANDARD FEATURES

- End bases are 18" inset from the end of the table top, lengthwise.
- End bases skew outward. Center base on tables over 120" in length is symmetrical.
- Select from 15 standard laminates or choose any standard Wilsonart, Nevamar, Formica, Arborite and Pionite matte finish laminates at no upcharge. For other laminate please contact the factory for pricing.
- 9 standard veneer and hardwood edge stains. Stain-to-match available at no upcharge.
- Standard with leveling glides.
- Bases available in any Spectone color.
- Standard 30" table height.
- Standard 1" table top.

OPTIONS

- For Power & Data modules, please see Table Accessories Price List.
- Vertical Wire Manager magnetically attaches to any base, add \$156 List each
- Radius corners.
- Other base heights may be available, please contact Factory.
- 2" built up edge table top available, contact Factory for pricing.

HOW TO ORDER

1. Select Model
2. Select Base
3. Select Edge Style
4. Select Options
5. Select Top Finish
6. Select Edge Finish
7. Select Base Finish

Example: 4296RE - ASK - PVF -





ASKEW TABLES BOARDROOM



| MODEL | TABLETOPS | | BASES | | TOP SPECIFICATIONS | | | | | | LBS |
|------------------|--------------------|------|-------|------------------|--------------------|--------------------|-------------------------------------|--------------------------------|-------------------------------------|-----|-----|
| | Number of Sections | Code | Qty. | For Laminate Top | | | For Veneer Top | | | | |
| | | | | SE PVF 2MM | HF HB | HBV HBVR HBG | HF2 HB2 HKN4 HKNR4 HBG2 | HF HB HBV HBVR HBG | HF2 HB2 HKN4 HKNR4 HBG2 | | |
| <i>Rectangle</i> | | | | | | | | | | | |
| 60 X 96RE | 1 | ASK | 2 | 5283 | 6458 | 6736 | 7337 | 7425 | 8258 | 203 | |
| 60 X 108RE | 1 | ASK | 2 | 5610 | 7244 | 7601 | 8152 | 8021 | 8992 | 223 | |
| 60 X 120RE | 2 | ASK | 2 | 5767 | 7524 | 7908 | 8500 | 8359 | 9404 | 243 | |
| 60 X 144RE | 2 | ASK | 3 | 7978 | 10087 | 10546 | 11257 | 11089 | 12342 | 292 | |
| 60 X 168RE | 2 | ASK | 3 | 8428 | 10887 | 11421 | 12253 | 12056 | 13516 | 330 | |
| 60 X 192RE | 2 | ASK | 3 | 9059 | 12007 | 12646 | 13644 | 13409 | 15163 | 369 | |
| 60 X 216RE | 2 | ASK | 3 | 9528 | 12847 | 13569 | 14689 | 14424 | 16394 | 407 | |



6096 RE ASK



WIRE MANAGER

STANDARD FEATURES

- End bases are 18" inset from the end of the table top, lengthwise.
- End bases skew outward. Center base on tables over 120" in length is symmetrical.
- Select from 15 standard laminates or choose any standard Wilsonart, Nevamar, Formica, Arborite and Pionite matte finish laminates at no upcharge. For other laminate please contact the factory for pricing.
- 9 standard veneer and hardwood edge stains. Stain-to-match available at no upcharge.
- Standard with leveling glides.
- Bases available in any Spectone color.
- Standard 30" table height.
- Standard 1" table top.

OPTIONS

- For Power & Data modules, please see Table Accessories Price List.
- Vertical Wire Manager magnetically attaches to any base, add \$156 List each
- Radius corners.
- Other base heights may be available, please contact Factory.
- 2" built up edge table top available, contact Factory for pricing.

HOW TO ORDER

1. Select Model
2. Select Base
3. Select Edge Style
4. Select Options
5. Select Top Finish
6. Select Edge Finish
7. Select Base Finish

Example: 6096RE - ASK - PVF -



BOARDGAMES TABLES



PRODUCT CODE

4896 BT BG EL - L

Top Size

Width x Length

Top Shape

D : Round
 SQ : Square
 RE : Rectangle
 REA: Rectangle Arc
 RT : Racetrack
 BT : Boatshape
 BTA : Boatshape Arc

EL : Ellipse
 VC : Video
 Conference
 VCA : Video
 Conference Arc

Series

BG : Boardgame
 PL : Plinth

Base Shape

DR : Drum
 RE : Rectangle
 SQ : Square
 EL : Ellipse
 DDR : D-Drum
 HDR : Half Drum

Finish

L : Laminate
 V : Veneer

OPTIONS

BASE



TRIM DETAIL



FINISHES

LAMINATE



Select from 15 standard laminates or choose any standard Wilsonart, Nevamar, Formica, Arborite and Pionite matte finish laminates at no upcharge

VENEER



Select from one of our 9 standard wood stains or stain-to-match at no upcharge

ALUMINUM BASE TRIM



Select from one of our 76 standard Spectone colors

EDGE



See Spectone Card or specfurniture.com/materials/finishes for a complete list of finish options and colors.



BOARDGAMES TABLES

BACK TO CONTENTS

HOW TO ORDER

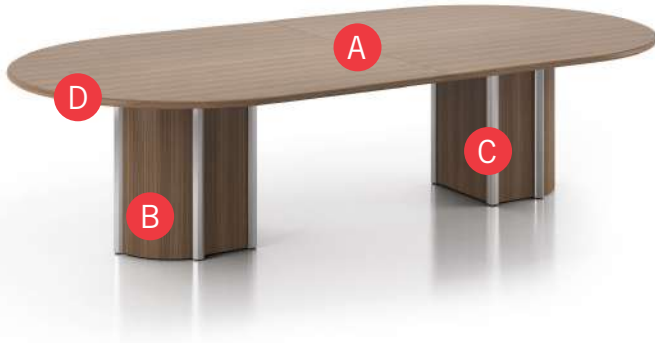

Specify Top Size (Width x Length) and Shape

- A** Specify Top Type and Finish
For Laminate Top: Manufacturer, Laminate Name, Laminate Code
For Veneer Top: Wood Stain
- B** Specify Edge Type, (for hardwood: Style), and Finish
PVC/2mm/Self Edge/Exposed Baltic Birch Plywood/Hardwood
- C** Specify Base Type and Finish
For Laminate Base: Manufacturer, Laminate Name, Laminate Code
For Veneer Base: Wood Stain
- D** Specify Base Trim Type and Finish
For Aluminum: RAL Color
For Wood: Wood Stain

Optional: Grommets, Power and Data Modules, Custom Solutions



| Top Size and Shape | Top Type and Finish | Edge Type and Finish | Base Type and Finish | Base Trim Type and Finish |
|--------------------|---------------------------------|--|---------------------------------|---------------------------|
| 24 x 72, Racetrack | Laminate, Arborite, Brown Sugar | Hardwood, HF, Custom Brown Sugar Stain | Laminate, Arborite, Brown Sugar | Aluminum, Silver |

BOARDGAMES TABLES BOARDROOM

TABLETOP SHAPES

On one piece tabletops, grain direction runs lengthwise.

On tabletops of two or more pieces, grain direction runs from side to side, as standard.

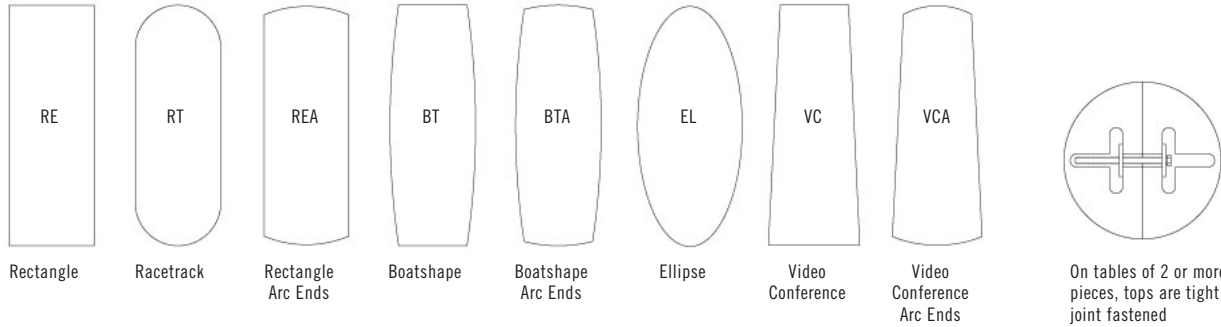

EDGE PROFILES

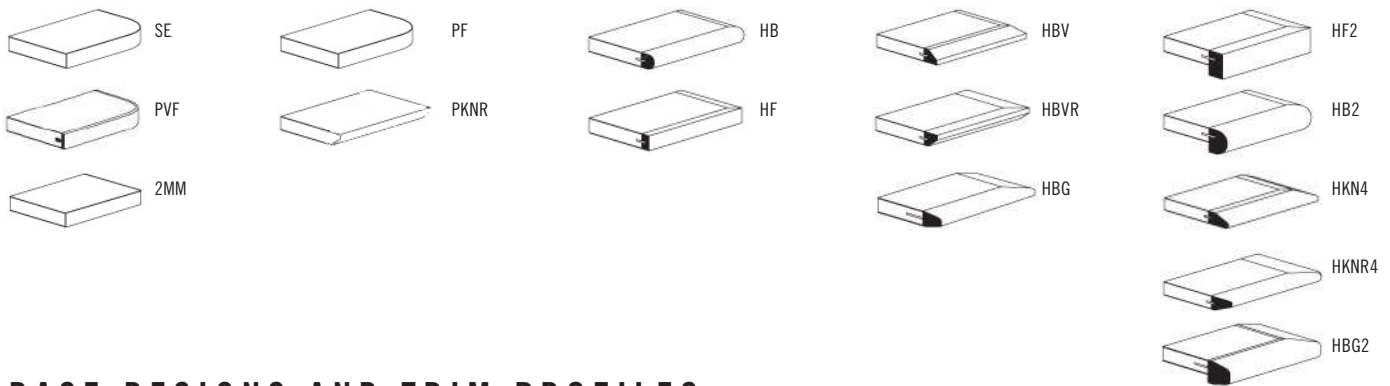

BASE DESIGNS AND TRIM PROFILES

Boardgames - Base Designs

Six different Boardgames bases are available, in laminate or veneer, standard at 22" width. For 30" width options, please contact Spec Customer Service. Each base features trim profiles in your choice of aluminum extrusion or wood. Aluminum extrusion is available in any Spectone color at no upcharge.

Wood trim on base stained in any of Spec's 9 standard stain colors or stain-to-match at no upcharge. The bases are standard with a removable door for wire access and a cutout at the top for wire pass-through.

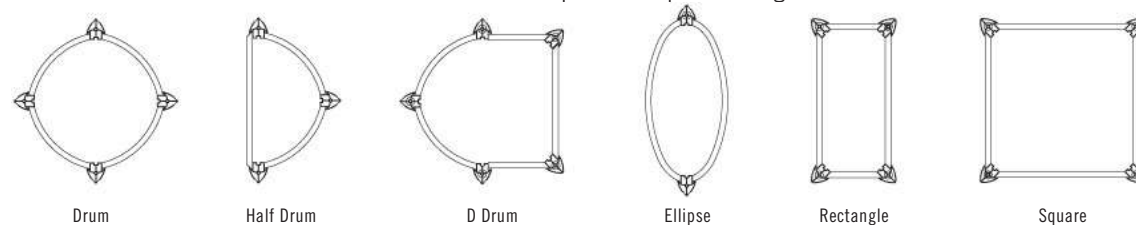

Boardgames - Base Trim Profiles

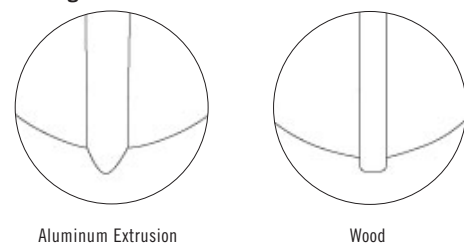



BOARDGAMES TABLES

BOARDROOM

TABLETOP



| MODEL | TABLETOPS | | TOP AND EDGE SPECIFICATIONS | | | | | | BASES | | LBS |
|--------------|-----------|--------------------|-----------------------------|----------|--------------------|-------------------------------------|--------------------------------|-------------------------------------|------------------------------|------------|-----|
| | Code | Number of Sections | For Laminate Top | | | For Veneer Top | | | Number of Bases Required | Base width | |
| | | | SE PVF 2MM | HF HB | HBV HBVR HBG | HF2 HB2 HKN4 HKNR4 HBG2 | HF HB HBV HBVR HBG | HF2 HB2 HKN4 HKNR4 HBG2 | BGDR BGSQ PLDR PLSQ | | |
| <i>Round</i> | | | | | | | | | | | |
| 42 | 42D | 1 | 667 | 1243 | 1367 | 1632 | 1658 | 1971 | 1 | 22" | 110 |
| 48 | 48D | 1 | 690 | 1463 | 1598 | 1730 | 2204 | 2606 | 1 | 22" | 126 |
| 54 | 54D | 1 | 980 | 2120 | 2330 | 2530 | 2766 | 3282 | 1 | 22" | 146 |
| 60 | 60D | 1 | 1028 | 2322 | 2546 | 2715 | 3401 | 4042 | 1 | 30" | 165 |



BASES

| MODEL | BASE SHAPES | FINISH | BASE PRICE | | LBS | |
|--------|-------------|--------------------|------------|----------|------|----|
| | | | 22" wide | 30" wide | | |
| BGDR-L | | BOARDGAME DRUM | Laminate | 1479 | 2071 | 75 |
| BGDR-V | | Veneer | 1654 | 2316 | 75 | |
| BGSQ-L | | BOARDGAME SQUARE | Laminate | 977 | 1368 | 70 |
| BGSQ-V | | Veneer | 1151 | 1611 | 70 | |
| PLDR-L | | PLINTH BASE DRUM | Laminate | 1479 | 2071 | 75 |
| PLDR-V | | Veneer | 1654 | 2316 | 75 | |
| PLSQ-L | | PLINTH BASE SQUARE | Laminate | 977 | 1368 | 70 |
| PLSQ-V | | Veneer | 1151 | 1611 | 70 | |



BGDR



BGSQ



PLSQ



PLDR

For applicable Power & Data modules, please see Table Accessories Price List.



BOARDGAMES TABLES

BOARDROOM

TABLETOP



| MODEL | TABLETOPS | | TOP AND EDGE SPECIFICATIONS | | | | | | BASES | | LBS |
|---------------|-----------|--------------------|-----------------------------|--|--------------------|-------------------------------------|--------------------------------|-------------------------------------|------------------------------|------------|-----|
| | Code | Number of Sections | For Laminate Top | | | For Veneer Top | | | Number of Bases Required | Base width | |
| | | | SE PVF 2MM | HF HB PKNR ¹ PF ¹ | HBV HBVR HBG | HF2 HB2 HKN4 HKNR4 HBG2 | HF HB HBV HBVR HBG | HF2 HB2 HKN4 HKNR4 HBG2 | BGDR BGSQ PLDR PLSQ | | |
| <i>Square</i> | | | | | | | | | | | |
| 36 x 36 | 36SQ | 1 | 400 | 623 | 685 | 895 | 903 | 1103 | 1 | 22" | 98 |
| 42 x 42 | 42SQ | 1 | 681 | 1004 | 1103 | 1203 | 1272 | 1545 | 1 | 22" | 112 |
| 48 x 48 | 48SQ | 1 | 835 | 1118 | 1223 | 1270 | 1648 | 2001 | 1 | 22" | 128 |
| 54 x 54 | 54SQ | 1 | 983 | 1607 | 1771 | 1961 | 2065 | 2522 | 1 | 22" | 146 |
| 60 x 60 | 60SQ | 1 | 1013 | 1713 | 1888 | 2079 | 2544 | 3097 | 1 | 30" | 165 |

¹ Exposed Baltic Birch plywood edge (PKNR, PF) can only be specified on tops up to 47-1/2" x 95-1/2". Clear finish only.



BASES

| MODEL | BASE SHAPES | FINISH | BASE PRICE | | LBS | |
|--------|-------------|--------------------|------------|----------|------|----|
| | | | 22" wide | 30" wide | | |
| BGDR-L | | BOARDGAME DRUM | Laminate | 1479 | 2071 | 75 |
| BGDR-V | | Veneer | 1654 | 2316 | 75 | |
| BGSQ-L | | BOARDGAME SQUARE | Laminate | 977 | 1368 | 70 |
| BGSQ-V | | Veneer | 1151 | 1611 | 70 | |
| PLDR-L | | PLINTH BASE DRUM | Laminate | 1479 | 2071 | 75 |
| PLDR-V | | Veneer | 1654 | 2316 | 75 | |
| PLSQ-L | | PLINTH BASE SQUARE | Laminate | 977 | 1368 | 70 |
| PLSQ-V | | Veneer | 1151 | 1611 | 70 | |



BGDR



BGSQ



PLSQ



PLDR



BACK TO CONTENTS

BOARDGAMES TABLES

BOARDROOM

TABLETOP

| MODEL | TABLETOPS | | TOP AND EDGE SPECIFICATIONS | | | | | | BASES | | LBS | |
|------------------|-----------|--------------------|-----------------------------|--|--------------------|-------------------------------------|--------------------------------|-------------------------------------|--------------------------|--|-----|------------|
| | Code | Number of Sections | For Laminate Top | | | For Veneer Top | | | Number of Bases Required | | | Base width |
| | | | SE PVF 2MM | HF HB PKNR ¹ PF ¹ | HBV HBVR HBG | HF2 HB2 HKN4 HKNR4 HBG2 | HF HB HBV HBVR HBG | HF2 HB2 HKN4 HKNR4 HBG2 | BGEL BGRE BGHDR* | BGDR BGSQ BGDDR* PLDR PLSQ | | |
| <i>Rectangle</i> | | | | | | | | | | | | |
| 48 x 96 | 4896RE | 1 | 1419 | 2329 | 2575 | 2824 | 3192 | 3904 | 2 | 2 | 22" | 135 |
| 48 x 120 | 48120RE | 2 | 1757 | 2932 | 3210 | 3811 | 3899 | 4732 | 3 | 2 | 22" | 168 |
| 48 x 144 | 48144RE | 2 | 2153 | 3838 | 4205 | 4776 | 4640 | 5642 | 3 | 3 | 22" | 202 |
| 48 x 168 | 48168RE | 2 | 2657 | 4353 | 4772 | 5569 | 5385 | 6549 | 3 | 3 | 22" | 236 |
| 48 x 192 | 48192RE | 2 | 2980 | 5189 | 5697 | 6834 | 6446 | 7838 | 3 | 3 | 22" | 269 |
| 48 x 216 | 48216RE | 2 | 3597 | 5784 | 6344 | 7554 | 7185 | 8755 | 3 | 3 | 22" | 303 |
| 60 x 120 | 60120RE | 2 | 2241 | 3998 | 4382 | 4974 | 4833 | 5878 | 3 | 2 | 30" | 210 |
| 60 x 144 | 60144RE | 2 | 2689 | 4798 | 5257 | 5968 | 5800 | 7053 | 3 | 3 | 30" | 252 |
| 60 x 168 | 60168RE | 2 | 3139 | 5598 | 6132 | 6964 | 6767 | 8227 | 3 | 3 | 30" | 294 |
| 60 x 192 | 60192RE | 2 | 3770 | 6718 | 7357 | 8355 | 8120 | 9874 | 3 | 3 | 30" | 336 |
| 60 x 216 | 60216RE | 2 | 4239 | 7558 | 8280 | 9400 | 9135 | 11105 | 3 | 3 | 30" | 378 |

*When specifying Half Drum (BGHDR) or D-Drum (BGDDR) bases where 3 bases are required, the middle base should be specified as a Rectangle base (BGRE).
¹ Exposed Baltic Birch plywood edge (PKNR, PF) can only be specified on tops up to 47-1/2" x 95-1/2". Clear finish only.

BASES

| MODEL | BASE SHAPES | | FINISH | BASE PRICE | | LBS | |
|---------|-------------|-----------------------|----------|-----------------------|----------|------|----------|
| | | | | Aluminum or Wood Trim | 22" wide | | 30" wide |
| BGDR-L | | BOARDGAME DRUM | Laminate | | 1479 | 2071 | 75 |
| BGDR-V | | | Veneer | | 1654 | 2316 | 75 |
| BGRE-L | | BOARDGAME RECTANGLE | Laminate | | 977 | 1368 | 70 |
| BGRE-V | | | Veneer | | 1151 | 1611 | 70 |
| BGSQ-L | | BOARDGAME SQUARE | Laminate | | 977 | 1368 | 70 |
| BGSQ-V | | | Veneer | | 1151 | 1611 | 70 |
| BGEL-L | | BOARDGAME ELLIPSE | Laminate | | 1046 | - | 65 |
| BGEL-V | | | Veneer | | 1224 | - | 65 |
| BGDDR-L | | BOARDGAME D-DRUM | Laminate | | 1650 | 2310 | 85 |
| BGDDR-V | | | Veneer | | 1830 | 2562 | 85 |
| BGHDR-L | | BOARDGAME HALF DRUM | Laminate | | 1191 | 1667 | 65 |
| BGHDR-V | | | Veneer | | 1368 | 1915 | 65 |
| PLDR-L | | PLINTH BASE DRUM | Laminate | | 1479 | 2071 | 75 |
| PLDR-V | | | Veneer | | 1654 | 2316 | 75 |
| PLSQ-L | | PLINTH BASE SQUARE | Laminate | | 977 | 1368 | 70 |
| PLSQ-V | | | Veneer | | 1151 | 1611 | 70 |
| PLRE-L | | PLINTH BASE RECTANGLE | Laminate | | 977 | 1368 | 70 |
| PLRE-V | | | Veneer | | 1151 | 1611 | 70 |



For applicable Power & Data modules, please see Table Accessories Price List.



BOARDGAMES TABLES

BOARDROOM

TABLETOP

| MODEL | TABLETOPS | | TOP AND EDGE SPECIFICATIONS | | | | | | BASES | | | LBS |
|---------------------------|-----------|--------------------|-----------------------------|----------|--------------------|-------------------------------------|--------------------------------|-------------------------------------|--------------------------|------------------------|--------------|-----|
| | Code | Number of Sections | For Laminate Top | | | For Veneer Top | | | Number of Bases Required | | Base width | |
| | | | SE PVF 2MM | HF HB | HBV HBVR HBG | HF2 HB2 HKN4 HKNR4 HBG2 | HF HB HBV HBVR HBG | HF2 HB2 HKN4 HKNR4 HBG2 | BGEL BGRE BGHDR* | BGDR BGSQ BGDDR* | PLDR PLSQ | |
| <i>Rectangle Arc Ends</i> | | | | | | | | | | | | |
| 48 x 96 | 4896REA | 1 | 1439 | 2468 | 2719 | 3322 | 3748 | 4507 | 2 | 2 | 22" | 135 |
| 48 x 120 | 48120REA | 2 | 1784 | 3416 | 3743 | 4574 | 4539 | 5426 | 3 | 2 | 22" | 168 |
| 48 x 144 | 48144REA | 2 | 2183 | 4216 | 4617 | 5647 | 5408 | 6484 | 3 | 3 | 22" | 202 |
| 48 x 168 | 48168REA | 2 | 2689 | 4900 | 5368 | 6512 | 6290 | 7537 | 3 | 3 | 22" | 236 |
| 48 x 192 | 48192REA | 2 | 2878 | 5764 | 6321 | 7424 | 7718 | 8592 | 3 | 3 | 22" | 269 |
| 48 x 216 | 48216REA | 2 | 3597 | 6464 | 7092 | 8458 | 8795 | 9645 | 3 | 3 | 22" | 303 |
| 60 x 120 | 60120REA | 2 | 2230 | 4270 | 4676 | 5720 | 5673 | 6786 | 3 | 2 | 30" | 210 |
| 60 x 144 | 60144REA | 2 | 2729 | 5270 | 5773 | 7063 | 6762 | 8106 | 3 | 3 | 30" | 252 |
| 60 x 168 | 60168REA | 2 | 3364 | 6129 | 6713 | 8139 | 7863 | 9421 | 3 | 3 | 30" | 294 |
| 60 x 192 | 60192REA | 2 | 4035 | 7354 | 8057 | 9768 | 10160 | 11307 | 3 | 3 | 30" | 336 |
| 60 x 216 | 60216REA | 2 | 4540 | 8272 | 9063 | 10989 | 11429 | 12719 | 3 | 3 | 30" | 378 |

*When specifying Half Drum (BGHDR) or D-Drum (BGDDR) bases where 3 bases are required, the middle base should be specified as a Rectangle base (BGRE).

BASES

| MODEL | BASE SHAPES | FINISH | BASE PRICE | | LBS | |
|---------|-------------|-----------------------|-----------------------|----------|------|----------|
| | | | Aluminum or Wood Trim | 22" wide | | 30" wide |
| BGDR-L | | BOARDGAME DRUM | Laminate | 1479 | 2071 | 75 |
| BGDR-V | | | Veneer | 1654 | 2316 | 75 |
| BGRE-L | | BOARDGAME RECTANGLE | Laminate | 977 | 1368 | 70 |
| BGRE-V | | | Veneer | 1151 | 1611 | 70 |
| BGSQ-L | | BOARDGAME SQUARE | Laminate | 977 | 1368 | 70 |
| BGSQ-V | | | Veneer | 1151 | 1611 | 70 |
| BGEL-L | | BOARDGAME ELLIPSE | Laminate | 1046 | - | 65 |
| BGEL-V | | | Veneer | 1224 | - | 65 |
| BGDDR-L | | BOARDGAME D-DRUM | Laminate | 1650 | 2310 | 85 |
| BGDDR-V | | | Veneer | 1830 | 2562 | 85 |
| BGHDR-L | | BOARDGAME HALF DRUM | Laminate | 1191 | 1667 | 65 |
| BGHDR-V | | | Veneer | 1368 | 1915 | 65 |
| PLDR-L | | PLINTH BASE DRUM | Laminate | 1479 | 2071 | 75 |
| PLDR-V | | | Veneer | 1654 | 2316 | 75 |
| PLSQ-L | | PLINTH BASE SQUARE | Laminate | 977 | 1368 | 70 |
| PLSQ-V | | | Veneer | 1151 | 1611 | 70 |
| PLRE-L | | PLINTH BASE RECTANGLE | Laminate | 977 | 1368 | 70 |
| PLRE-V | | | Veneer | 1151 | 1611 | 70 |



For applicable Power & Data modules, please see Table Accessories Price List.



BACK TO CONTENTS

BOARDGAMES TABLES

BOARDROOM

TABLETOP

| MODEL | TABLETOPS | | TOP AND EDGE SPECIFICATIONS | | | | | | BASES | | | LBS |
|------------------|-----------|--------------------|-----------------------------|----------|--------------------|-------------------------------------|--------------------------------|-------------------------------------|--------------------------|------------------------|--------------|-----|
| | Code | Number of Sections | For Laminate Top | | | For Veneer Top | | | Number of Bases Required | | Base width | |
| | | | SE PVF 2MM | HF HB | HBV HBVR HBG | HF2 HB2 HKN4 HKNR4 HBG2 | HF HB HBV HBVR HBG | HF2 HB2 HKN4 HKNR4 HBG2 | BGEL BGRE BGHDR* | BGDR BGSQ BGDDR* | PLDR PLSQ | |
| <i>Racetrack</i> | | | | | | | | | | | | |
| 48 x 96 | 4896RT | 1 | 1439 | 2468 | 2719 | 3322 | 3748 | 4507 | 2 | 2 | 22" | 135 |
| 48 x 120 | 48120RT | 2 | 1784 | 3416 | 3743 | 4574 | 4539 | 5426 | 3 | 2 | 22" | 168 |
| 48 x 144 | 48144RT | 2 | 2183 | 4216 | 4617 | 5647 | 5408 | 6484 | 3 | 3 | 22" | 202 |
| 48 x 168 | 48168RT | 2 | 2689 | 4900 | 5368 | 6512 | 6290 | 7537 | 3 | 3 | 22" | 236 |
| 48 x 192 | 48192RT | 2 | 2878 | 5764 | 6321 | 7424 | 7718 | 8592 | 3 | 3 | 22" | 269 |
| 48 x 216 | 48216RT | 2 | 3597 | 6464 | 7092 | 8458 | 8795 | 9645 | 3 | 3 | 22" | 303 |
| 60 x 120 | 60120RT | 2 | 2230 | 4270 | 4676 | 5720 | 5673 | 6786 | 3 | 2 | 30" | 210 |
| 60 x 144 | 60144RT | 2 | 2729 | 5270 | 5773 | 7063 | 6762 | 8106 | 3 | 3 | 30" | 252 |
| 60 x 168 | 60168RT | 2 | 3364 | 6129 | 6713 | 8139 | 7863 | 9421 | 3 | 3 | 30" | 294 |
| 60 x 192 | 60192RT | 2 | 4035 | 7354 | 8057 | 9768 | 10160 | 11307 | 3 | 3 | 30" | 336 |
| 60 x 216 | 60216RT | 2 | 4540 | 8272 | 9063 | 10989 | 11429 | 12719 | 3 | 3 | 30" | 378 |

*When specifying Half Drum (BGHDR) or D-Drum (BGDDR) bases where 3 bases are required, the middle base should be specified as a Rectangle base (BGRE).

BASES

| MODEL | BASE SHAPES | | FINISH | BASE PRICE | | LBS |
|---------|-------------|-----------------------|----------|-----------------------|----------|-----|
| | | | | Aluminum or Wood Trim | 22" wide | |
| BGDR-L | | BOARDGAME DRUM | Laminate | 1479 | 2071 | 75 |
| BGDR-V | | | Veneer | 1654 | 2316 | 75 |
| BGRE-L | | BOARDGAME RECTANGLE | Laminate | 977 | 1368 | 70 |
| BGRE-V | | | Veneer | 1151 | 1611 | 70 |
| BGSQ-L | | BOARDGAME SQUARE | Laminate | 977 | 1368 | 70 |
| BGSQ-V | | | Veneer | 1151 | 1611 | 70 |
| BGEL-L | | BOARDGAME ELLIPSE | Laminate | 1046 | - | 65 |
| BGEL-V | | | Veneer | 1224 | - | 65 |
| BGDDR-L | | BOARDGAME D-DRUM | Laminate | 1650 | 2310 | 85 |
| BGDDR-V | | | Veneer | 1830 | 2562 | 85 |
| BGHDR-L | | BOARDGAME HALF DRUM | Laminate | 1191 | 1667 | 65 |
| BGHDR-V | | | Veneer | 1368 | 1915 | 65 |
| PLDR-L | | PLINTH BASE DRUM | Laminate | 1479 | 2071 | 75 |
| PLDR-V | | | Veneer | 1654 | 2316 | 75 |
| PLSQ-L | | PLINTH BASE SQUARE | Laminate | 977 | 1368 | 70 |
| PLSQ-V | | | Veneer | 1151 | 1611 | 70 |
| PLRE-L | | PLINTH BASE RECTANGLE | Laminate | 977 | 1368 | 70 |
| PLRE-V | | | Veneer | 1151 | 1611 | 70 |



For applicable Power & Data modules, please see Table Accessories Price List.



BACK TO CONTENTS

BOARDGAMES TABLES

BOARDROOM

TABLETOP



| MODEL | TABLETOPS | | TOP AND EDGE SPECIFICATIONS | | | | | | BASES | | | LBS |
|------------------|-----------|--------------------|-----------------------------|----------|--------------------|-------------------------------------|--------------------------------|-------------------------------------|--------------------------|------------------------|--------------|-----|
| | Code | Number of Sections | For Laminate Top | | | For Veneer Top | | | Number of Bases Required | | Base width | |
| | | | SE PVF 2MM | HF HB | HBV HBVR HBG | HF2 HB2 HKN4 HKNR4 HBG2 | HF HB HBV HBVR HBG | HF2 HB2 HKN4 HKNR4 HBG2 | BGEL BGRE BGHDR* | BGDR BGSQ BGDDR* | PLDR PLSQ | |
| <i>Boatshape</i> | | | | | | | | | | | | |
| 48 x 96 | 4896BT | 1 | 1439 | 3170 | 3492 | 3824 | 4295 | 4709 | 2 | 2 | 22" | 135 |
| 48 x 120 | 48120BT | 2 | 1784 | 4185 | 4584 | 5006 | 5185 | 5664 | 3 | 2 | 22" | 168 |
| 48 x 144 | 48144BT | 2 | 2183 | 4986 | 5462 | 5968 | 6606 | 7041 | 3 | 3 | 22" | 202 |
| 48 x 168 | 48168BT | 2 | 2689 | 5751 | 6306 | 6890 | 7188 | 7860 | 3 | 3 | 22" | 236 |
| 48 x 192 | 48192BT | 2 | 2878 | 6632 | 7271 | 8535 | 8875 | 9881 | 3 | 3 | 22" | 269 |
| 48 x 216 | 48216BT | 2 | 3597 | 7432 | 8153 | 9726 | 10115 | 11091 | 3 | 3 | 22" | 303 |
| 60 x 120 | 60120BT | 2 | 2230 | 5229 | 5732 | 6258 | 6484 | 7078 | 3 | 2 | 30" | 210 |
| 60 x 144 | 60144BT | 2 | 2729 | 6234 | 6829 | 7462 | 8257 | 8803 | 3 | 3 | 30" | 252 |
| 60 x 168 | 60168BT | 2 | 3364 | 7192 | 7883 | 8614 | 8984 | 9826 | 3 | 3 | 30" | 294 |
| 60 x 192 | 60192BT | 2 | 4035 | 8629 | 9459 | 10338 | 10781 | 11790 | 3 | 3 | 30" | 336 |
| 60 x 216 | 60216BT | 2 | 4540 | 9707 | 10643 | 11630 | 12128 | 13266 | 3 | 3 | 30" | 378 |

*When specifying Half Drum (BGHDR) or D-Drum (BGDDR) bases where 3 bases are required, the middle base should be specified as a Rectangle base (BGRE).

BASES

| MODEL | BASE SHAPES | FINISH | BASE PRICE | | LBS | |
|---------|-------------|-----------------------|-----------------------|----------|------|----------|
| | | | Aluminum or Wood Trim | 22" wide | | 30" wide |
| BGDR-L | | BOARDGAME DRUM | Laminate | 1479 | 2071 | 75 |
| BGDR-V | | | Veneer | 1654 | 2316 | 75 |
| BGRE-L | | BOARDGAME RECTANGLE | Laminate | 977 | 1368 | 70 |
| BGRE-V | | | Veneer | 1151 | 1611 | 70 |
| BGSQ-L | | BOARDGAME SQUARE | Laminate | 977 | 1368 | 70 |
| BGSQ-V | | | Veneer | 1151 | 1611 | 70 |
| BGEL-L | | BOARDGAME ELLIPSE | Laminate | 1046 | - | 65 |
| BGEL-V | | | Veneer | 1224 | - | 65 |
| BGDDR-L | | BOARDGAME D-DRUM | Laminate | 1650 | 2310 | 85 |
| BGDDR-V | | | Veneer | 1830 | 2562 | 85 |
| BGHDR-L | | BOARDGAME HALF DRUM | Laminate | 1191 | 1667 | 65 |
| BGHDR-V | | | Veneer | 1368 | 1915 | 65 |
| PLDR-L | | PLINTH BASE DRUM | Laminate | 1479 | 2071 | 75 |
| PLDR-V | | | Veneer | 1654 | 2316 | 75 |
| PLSQ-L | | PLINTH BASE SQUARE | Laminate | 977 | 1368 | 70 |
| PLSQ-V | | | Veneer | 1151 | 1611 | 70 |
| PLRE-L | | PLINTH BASE RECTANGLE | Laminate | 977 | 1368 | 70 |
| PLRE-V | | | Veneer | 1151 | 1611 | 70 |



For applicable Power & Data modules, please see Table Accessories Price List.



BOARDGAMES TABLES

BOARDROOM

TABLETOP



| MODEL | TABLETOPS | | TOP AND EDGE SPECIFICATIONS | | | | | | BASES | | | LBS |
|---------------------------|-----------|--------------------|-----------------------------|----------|--------------------|-------------------------------------|--------------------------------|-------------------------------------|--------------------------|------------------------|--------------|-----|
| | Code | Number of Sections | For Laminate Top | | | For Veneer Top | | | Number of Bases Required | | Base width | |
| | | | SE PVF 2MM | HF HB | HBV HBVR HBG | HF2 HB2 HKN4 HKNR4 HBG2 | HF HB HBV HBVR HBG | HF2 HB2 HKN4 HKNR4 HBG2 | BGEL BGRE BGHDR* | BGDR BGSQ BGDDR* | PLDR PLSQ | |
| <i>Boatshape Arc Ends</i> | | | | | | | | | | | | |
| 48 x 96 | 4896BTA | 1 | 1615 | 3721 | 4045 | 4379 | 4847 | 5261 | 2 | 2 | 22" | 135 |
| 48 x 120 | 48120BTA | 2 | 1959 | 4739 | 5139 | 5561 | 5740 | 6215 | 3 | 2 | 22" | 168 |
| 48 x 144 | 48144BTA | 2 | 2359 | 5537 | 6017 | 6523 | 7157 | 7595 | 3 | 3 | 22" | 202 |
| 48 x 168 | 48168BTA | 2 | 2866 | 6306 | 6861 | 7445 | 7741 | 8416 | 3 | 3 | 22" | 236 |
| 48 x 192 | 48192BTA | 2 | 3166 | 7295 | 7997 | 9390 | 9765 | 10869 | 3 | 3 | 22" | 269 |
| 48 x 216 | 48216BTA | 2 | 3955 | 8178 | 8970 | 10698 | 11128 | 12201 | 3 | 3 | 22" | 303 |
| 60 x 120 | 60120BTA | 2 | 2451 | 5924 | 6423 | 6950 | 7174 | 7769 | 3 | 2 | 30" | 210 |
| 60 x 144 | 60144BTA | 2 | 2948 | 6923 | 7522 | 8153 | 8949 | 9492 | 3 | 3 | 30" | 252 |
| 60 x 168 | 60168BTA | 2 | 3583 | 7883 | 8575 | 9304 | 9677 | 10521 | 3 | 3 | 30" | 294 |
| 60 x 192 | 60192BTA | 2 | 4300 | 9459 | 10290 | 11163 | 11612 | 12625 | 3 | 3 | 30" | 336 |
| 60 x 216 | 60216BTA | 2 | 4840 | 10643 | 11577 | 12560 | 13062 | 14201 | 3 | 3 | 30" | 378 |

*When specifying Half Drum (BGHDR) or D-Drum (BGDDR) bases where 3 bases are required, the middle base should be specified as a Rectangle base (BGRE).

BASES

| MODEL | BASE SHAPES | FINISH | BASE PRICE | | LBS | |
|---------|-------------|-----------------------|-----------------------|----------|------|----------|
| | | | Aluminum or Wood Trim | 22" wide | | 30" wide |
| BGDR-L | | BOARDGAME DRUM | Laminate | 1479 | 2071 | 75 |
| BGDR-V | | | Veneer | 1654 | 2316 | 75 |
| BGRE-L | | BOARDGAME RECTANGLE | Laminate | 977 | 1368 | 70 |
| BGRE-V | | | Veneer | 1151 | 1611 | 70 |
| BGSQ-L | | BOARDGAME SQUARE | Laminate | 977 | 1368 | 70 |
| BGSQ-V | | | Veneer | 1151 | 1611 | 70 |
| BGEL-L | | BOARDGAME ELLIPSE | Laminate | 1046 | - | 65 |
| BGEL-V | | | Veneer | 1224 | - | 65 |
| BGDDR-L | | BOARDGAME D-DRUM | Laminate | 1650 | 2310 | 85 |
| BGDDR-V | | | Veneer | 1830 | 2562 | 85 |
| BGHDR-L | | BOARDGAME HALF DRUM | Laminate | 1191 | 1667 | 65 |
| BGHDR-V | | | Veneer | 1368 | 1915 | 65 |
| PLDR-L | | PLINTH BASE DRUM | Laminate | 1479 | 2071 | 75 |
| PLDR-V | | | Veneer | 1654 | 2316 | 75 |
| PLSQ-L | | PLINTH BASE SQUARE | Laminate | 977 | 1368 | 70 |
| PLSQ-V | | | Veneer | 1151 | 1611 | 70 |
| PLRE-L | | PLINTH BASE RECTANGLE | Laminate | 977 | 1368 | 70 |
| PLRE-V | | | Veneer | 1151 | 1611 | 70 |



For applicable Power & Data modules, please see Table Accessories Price List.



BOARDGAMES TABLES

BOARDROOM

TABLETOP



| MODEL | TABLETOPS | | TOP AND EDGE SPECIFICATIONS | | | | | | BASES | | LBS | |
|----------------|-----------|--------------------|-----------------------------|----------|--------------------|-------------------------------------|--------------------------------|-------------------------------------|--------------------------|------------------------|-----|------------|
| | Code | Number of Sections | For Laminate Top | | | For Veneer Top | | | Number of Bases Required | | | Base width |
| | | | SE PVF 2MM | HF HB | HBV HBVR HBG | HF2 HB2 HKN4 HKNR4 HBG2 | HF HB HBV HBVR HBG | HF2 HB2 HKN4 HKNR4 HBG2 | BGEL BGRE BGHDR* | BGDR BGSQ BGDDR* | | |
| <i>Ellipse</i> | | | | | | | | | | | | |
| 48 x 96 | 4896EL | 1 | 1727 | 3803 | 4190 | 4591 | 5152 | 5648 | 2 | 2 | 22" | 135 |
| 48 x 120 | 48120EL | 2 | 2141 | 5022 | 5503 | 6007 | 6224 | 6793 | 3 | 2 | 22" | 168 |
| 48 x 144 | 48144EL | 2 | 2619 | 5983 | 6555 | 7164 | 7927 | 8451 | 3 | 3 | 22" | 202 |
| 48 x 168 | 48168EL | 2 | 3229 | 6901 | 7568 | 8268 | 8598 | 9434 | 3 | 3 | 22" | 236 |
| 48 x 192 | 48192EL | 2 | 3480 | 8025 | 8796 | 10327 | 10742 | 11957 | 3 | 3 | 22" | 269 |
| 48 x 216 | 48216EL | 2 | 4351 | 8995 | 9866 | 11768 | 12239 | 13421 | 3 | 3 | 22" | 303 |
| 60 x 120 | 60120EL | 2 | 2819 | 6813 | 7386 | 7992 | 8250 | 8934 | 3 | 2 | 30" | 210 |
| 60 x 144 | 60144EL | 2 | 3390 | 7961 | 8649 | 9378 | 10290 | 10917 | 3 | 3 | 30" | 252 |
| 60 x 168 | 60168EL | 2 | 4120 | 9067 | 9862 | 10701 | 11130 | 12097 | 3 | 3 | 30" | 294 |
| 60 x 192 | 60192EL | 2 | 4947 | 10877 | 11833 | 12839 | 13354 | 14518 | 3 | 3 | 30" | 336 |
| 60 x 216 | 60216EL | 2 | 5566 | 12239 | 13314 | 14442 | 15023 | 16330 | 3 | 3 | 30" | 378 |

*When specifying Half Drum (BGHDR) or D-Drum (BGDDR) bases where 3 bases are required, the middle base should be specified as a Rectangle base (BGRE).

BASES

| MODEL | BASE SHAPES | | FINISH | BASE PRICE | | LBS |
|---------|-------------|-----------------------|----------|-----------------------|----------|-----|
| | | | | Aluminum or Wood Trim | 22" wide | |
| BGDR-L | | BOARDGAME DRUM | Laminate | 1479 | 2071 | 75 |
| BGDR-V | | | Veneer | 1654 | 2316 | 75 |
| BGRE-L | | BOARDGAME RECTANGLE | Laminate | 977 | 1368 | 70 |
| BGRE-V | | | Veneer | 1151 | 1611 | 70 |
| BGSQ-L | | BOARDGAME SQUARE | Laminate | 977 | 1368 | 70 |
| BGSQ-V | | | Veneer | 1151 | 1611 | 70 |
| BGEL-L | | BOARDGAME ELLIPSE | Laminate | 1046 | - | 65 |
| BGEL-V | | | Veneer | 1224 | - | 65 |
| BGDDR-L | | BOARDGAME D-DRUM | Laminate | 1650 | 2310 | 85 |
| BGDDR-V | | | Veneer | 1830 | 2562 | 85 |
| BGHDR-L | | BOARDGAME HALF DRUM | Laminate | 1191 | 1667 | 65 |
| BGHDR-V | | | Veneer | 1368 | 1915 | 65 |
| PLDR-L | | PLINTH BASE DRUM | Laminate | 1479 | 2071 | 75 |
| PLDR-V | | | Veneer | 1654 | 2316 | 75 |
| PLSQ-L | | PLINTH BASE SQUARE | Laminate | 977 | 1368 | 70 |
| PLSQ-V | | | Veneer | 1151 | 1611 | 70 |
| PLRE-L | | PLINTH BASE RECTANGLE | Laminate | 977 | 1368 | 70 |
| PLRE-V | | | Veneer | 1151 | 1611 | 70 |



For applicable Power & Data modules, please see Table Accessories Price List.



BACK TO CONTENTS

BOARDGAMES TABLES BOARDROOM TABLETOP

| MODEL | TABLETOPS | | TOP AND EDGE SPECIFICATIONS | | | | | | BASES | | | LBS |
|-------------------------|-----------|--------------------|-----------------------------|----------|--------------------|-------------------------------------|--------------------------------|-------------------------------------|--------------------------|------------------------|------------|-----|
| | Code | Number of Sections | For Laminate Top | | | For Veneer Top | | | Number of Bases Required | | Base width | |
| | | | SE PVF 2MM | HF HB | HBV HBVR HBG | HF2 HB2 HKN4 HKNR4 HBG2 | HF HB HBV HBVR HBG | HF2 HB2 HKN4 HKNR4 HBG2 | BGEL BGRE BGHDR* | BGDR BGSQ BGDDR* | | |
| <i>Video Conference</i> | | | | | | | | | | | | |
| 48 x 96 | 4896VC | 1 | 1439 | 3170 | 3492 | 3824 | 4295 | 4709 | 2 | 2 | 22" | 135 |
| 48 x 120 | 48120VC | 2 | 1784 | 4185 | 4584 | 5006 | 5185 | 5664 | 3 | 2 | 22" | 168 |
| 48 x 144 | 48144VC | 2 | 2183 | 4986 | 5462 | 5968 | 6606 | 7041 | 3 | 3 | 22" | 202 |
| 48 x 168 | 48168VC | 2 | 2689 | 5751 | 6306 | 6890 | 7167 | 7860 | 3 | 3 | 22" | 236 |
| 48 x 192 | 48192VC | 2 | 2878 | 6632 | 7271 | 8535 | 8875 | 9881 | 3 | 3 | 22" | 269 |
| 48 x 216 | 48216VC | 2 | 3597 | 7432 | 8153 | 9726 | 10115 | 11091 | 3 | 3 | 22" | 303 |
| 60 x 120 | 60120VC | 2 | 2230 | 5229 | 5732 | 6258 | 6484 | 7078 | 3 | 2 | 30" | 210 |
| 60 x 144 | 60144VC | 2 | 2729 | 6234 | 6829 | 7462 | 8257 | 8803 | 3 | 3 | 30" | 252 |
| 60 x 168 | 60168VC | 2 | 3364 | 7192 | 7883 | 8614 | 8984 | 9826 | 3 | 3 | 30" | 294 |
| 60 x 192 | 60192VC | 2 | 4035 | 8629 | 9459 | 10338 | 10781 | 11790 | 3 | 3 | 30" | 336 |
| 60 x 216 | 60216VC | 2 | 4540 | 9707 | 10643 | 11630 | 12128 | 13266 | 3 | 3 | 30" | 378 |

*When specifying Half Drum (BGHDR) or D-Drum (BGDDR) bases where 3 bases are required, the middle base should be specified as a Rectangle base (BGRE).

BASES

| MODEL | BASE SHAPES | FINISH | BASE PRICE | | LBS | |
|---------|-------------|-----------------------|-----------------------|----------|------|----------|
| | | | Aluminum or Wood Trim | 22" wide | | 30" wide |
| BGDR-L | | BOARDGAME DRUM | Laminate | 1479 | 2071 | 75 |
| BGDR-V | | | Veneer | 1654 | 2316 | 75 |
| BGRE-L | | BOARDGAME RECTANGLE | Laminate | 977 | 1368 | 70 |
| BGRE-V | | | Veneer | 1151 | 1611 | 70 |
| BGSQ-L | | BOARDGAME SQUARE | Laminate | 977 | 1368 | 70 |
| BGSQ-V | | | Veneer | 1151 | 1611 | 70 |
| BGEL-L | | BOARDGAME ELLIPSE | Laminate | 1046 | - | 65 |
| BGEL-V | | | Veneer | 1224 | - | 65 |
| BGDDR-L | | BOARDGAME D-DRUM | Laminate | 1650 | 2310 | 85 |
| BGDDR-V | | | Veneer | 1830 | 2562 | 85 |
| BGHDR-L | | BOARDGAME HALF DRUM | Laminate | 1191 | 1667 | 65 |
| BGHDR-V | | | Veneer | 1368 | 1915 | 65 |
| PLDR-L | | PLINTH BASE DRUM | Laminate | 1479 | 2071 | 75 |
| PLDR-V | | | Veneer | 1654 | 2316 | 75 |
| PLSQ-L | | PLINTH BASE SQUARE | Laminate | 977 | 1368 | 70 |
| PLSQ-V | | | Veneer | 1151 | 1611 | 70 |
| PLRE-L | | PLINTH BASE RECTANGLE | Laminate | 977 | 1368 | 70 |
| PLRE-V | | | Veneer | 1151 | 1611 | 70 |



For applicable Power & Data modules, please see Table Accessories Price List.



BOARDGAMES TABLES

BOARDROOM

TABLETOP

| MODEL | TABLETOPS | | TOP AND EDGE SPECIFICATIONS | | | | | | BASES | | | LBS |
|----------------------------------|-----------|--------------------|-----------------------------|----------|--------------------|-------------------------------------|--------------------------------|-------------------------------------|--------------------------|------------------------|--------------|-----|
| | Code | Number of Sections | For Laminate Top | | | For Veneer Top | | | Number of Bases Required | | Base width | |
| | | | SE PVF 2MM | HF HB | HBV HBVR HBG | HF2 HB2 HKN4 HKNR4 HBG2 | HF HB HBV HBVR HBG | HF2 HB2 HKN4 HKNR4 HBG2 | BGEL BGRE BGHDR* | BGDR BGSQ BGDDR* | PLDR PLSQ | |
| <i>Video Conference Arc Ends</i> | | | | | | | | | | | | |
| 48 x 96 | 4896VCA | 1 | 1615 | 3721 | 4045 | 4379 | 4847 | 5261 | 2 | 2 | 22" | 135 |
| 48 x 120 | 48120VCA | 2 | 1959 | 4739 | 5139 | 5561 | 5740 | 6215 | 3 | 2 | 22" | 168 |
| 48 x 144 | 48144VCA | 2 | 2359 | 5537 | 6017 | 6523 | 7157 | 7595 | 3 | 3 | 22" | 202 |
| 48 x 168 | 48168VCA | 2 | 2866 | 6306 | 6861 | 7445 | 7741 | 8416 | 3 | 3 | 22" | 236 |
| 48 x 192 | 48192VCA | 2 | 3166 | 7295 | 7997 | 9390 | 9765 | 10869 | 3 | 3 | 22" | 269 |
| 48 x 216 | 48216VCA | 2 | 3955 | 8178 | 8970 | 10698 | 11128 | 12201 | 3 | 3 | 22" | 303 |
| 60 x 120 | 60120VCA | 2 | 2451 | 5924 | 6423 | 6950 | 7174 | 7769 | 3 | 2 | 30" | 210 |
| 60 x 144 | 60144VCA | 2 | 2948 | 6923 | 7522 | 8153 | 8949 | 9492 | 3 | 3 | 30" | 252 |
| 60 x 168 | 60168VCA | 2 | 3583 | 7883 | 8575 | 9304 | 9677 | 10521 | 3 | 3 | 30" | 294 |
| 60 x 192 | 60192VCA | 2 | 4300 | 9459 | 10290 | 11163 | 11612 | 12625 | 3 | 3 | 30" | 336 |
| 60 x 216 | 60216VCA | 2 | 4840 | 10643 | 11577 | 12560 | 13062 | 14201 | 3 | 3 | 30" | 378 |

*When specifying Half Drum (BGHDR) or D-Drum (BGDDR) bases where 3 bases are required, the middle base should be specified as a Rectangle base (BGRE).

BASES

| MODEL | BASE SHAPES | FINISH | BASE PRICE | | LBS | |
|---------|-------------|-----------------------|-----------------------|----------|------|----------|
| | | | Aluminum or Wood Trim | 22" wide | | 30" wide |
| BGDR-L | | BOARDGAME DRUM | Laminate | 1479 | 2071 | 75 |
| BGDR-V | | | Veneer | 1654 | 2316 | 75 |
| BGRE-L | | BOARDGAME RECTANGLE | Laminate | 977 | 1368 | 70 |
| BGRE-V | | | Veneer | 1151 | 1611 | 70 |
| BGSQ-L | | BOARDGAME SQUARE | Laminate | 977 | 1368 | 70 |
| BGSQ-V | | | Veneer | 1151 | 1611 | 70 |
| BGEL-L | | BOARDGAME ELLIPSE | Laminate | 1046 | - | 65 |
| BGEL-V | | | Veneer | 1224 | - | 65 |
| BGDDR-L | | BOARDGAME D-DRUM | Laminate | 1650 | 2310 | 85 |
| BGDDR-V | | | Veneer | 1830 | 2562 | 85 |
| BGHDR-L | | BOARDGAME HALF DRUM | Laminate | 1191 | 1667 | 65 |
| BGHDR-V | | | Veneer | 1368 | 1915 | 65 |
| PLDR-L | | PLINTH BASE DRUM | Laminate | 1479 | 2071 | 75 |
| PLDR-V | | | Veneer | 1654 | 2316 | 75 |
| PLSQ-L | | PLINTH BASE SQUARE | Laminate | 977 | 1368 | 70 |
| PLSQ-V | | | Veneer | 1151 | 1611 | 70 |
| PLRE-L | | PLINTH BASE RECTANGLE | Laminate | 977 | 1368 | 70 |
| PLRE-V | | | Veneer | 1151 | 1611 | 70 |



For applicable Power & Data modules, please see Table Accessories Price List.

BOARDGAMES TABLES

TABLETOP SECTIONS AND SEATING LAYOUTS

| RECTANGLE | | |
|---------------------|------------------------------------|--|
| <i>Size / Shape</i> | <i>Number of Tabletop Sections</i> | <i>Number of Chairs (based on 25" wide chairs)</i> |
| 48 x 96RE | 1 | 8 |
| 48 x 120RE | 2 | 10 |
| 48 x 144RE | 2 | 10 |
| 48 x 168RE | 2 | 12 |
| 48 x 192RE | 2 | 14 |
| 48 x 216RE | 2 | 14 |
| 60 x 120RE | 2 | 10 |
| 60 x 144RE | 2 | 12 |
| 60 x 168RE | 2 | 12 |
| 60 x 192RE | 2 | 14 |
| 60 x 216RE | 2 | 16 |

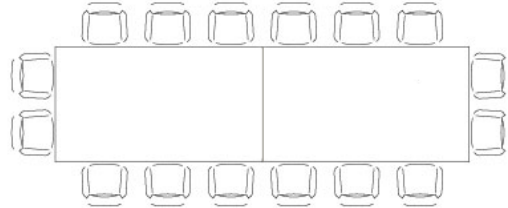

Rectangle 60x216

| RACETRACK | | |
|---------------------|------------------------------------|--|
| <i>Size / Shape</i> | <i>Number of Tabletop Sections</i> | <i>Number of Chairs (based on 25" wide chairs)</i> |
| 48 x 96RT | 1 | 8 |
| 48 x 120RT | 2 | 10 |
| 48 x 144RT | 2 | 10 |
| 48 x 168RT | 2 | 12 |
| 48 x 192RT | 2 | 14 |
| 48 x 216RT | 2 | 14 |
| 60 x 120RT | 2 | 10 |
| 60 x 144RT | 2 | 12 |
| 60 x 168RT | 2 | 12 |
| 60 x 192RT | 2 | 14 |
| 60 x 216RT | 2 | 16 |

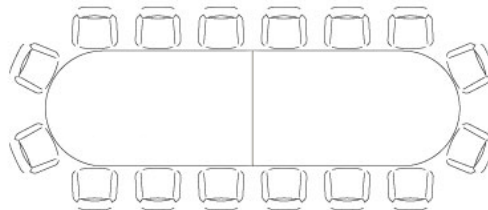

Racetrack 60x216

| RECTANGLE ARC ENDS | | |
|---------------------|------------------------------------|--|
| <i>Size / Shape</i> | <i>Number of Tabletop Sections</i> | <i>Number of Chairs (based on 25" wide chairs)</i> |
| 48 x 96REA | 1 | 8 |
| 48 x 120REA | 2 | 10 |
| 48 x 144REA | 2 | 10 |
| 48 x 168REA | 2 | 12 |
| 48 x 192REA | 2 | 14 |
| 48 x 216REA | 2 | 14 |
| 60 x 120REA | 2 | 10 |
| 60 x 144REA | 2 | 12 |
| 60 x 168REA | 2 | 12 |
| 60 x 192REA | 2 | 14 |
| 60 x 216REA | 2 | 16 |

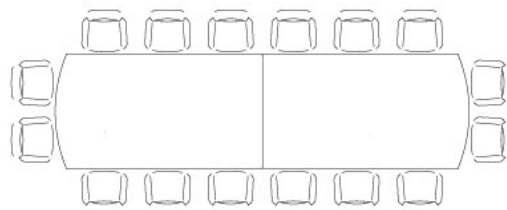

Rectangle Arc Ends 60x216

BOARDGAMES TABLES

TABLETOP SECTIONS AND SEATING LAYOUTS

| BOATSHAPE | | |
|--------------------------------|-----------------------------|---|
| Size / Shape | Number of Tabletop Sections | Number of Chairs (based on 25" wide chairs) |
| 48 x 96BT | 1 | 8 |
| 48 x 120BT | 2 | 10 |
| 48 x 144BT | 2 | 10 |
| 48 x 168BT | 2 | 12 |
| 48 x 192BT | 2 | 14 |
| 48 x 216BT | 2 | 14 |
| 60 x 120BT | 2 | 10 |
| 60 x 144BT | 2 | 12 |
| 60 x 168BT | 2 | 12 |
| 60 x 192BT | 2 | 14 |
| 60 x 216BT | 2 | 16 |
| <i>Standard with 12" Taper</i> | | |

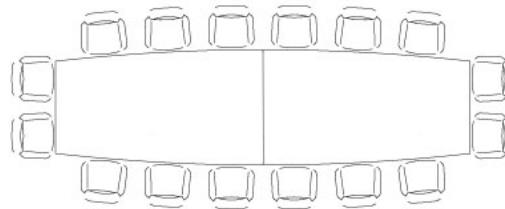

Boatshape 60x216

| BOATSHAPE ARC ENDS | | |
|--------------------|-----------------------------|---|
| Size / Shape | Number of Tabletop Sections | Number of Chairs (based on 25" wide chairs) |
| 48 x 96BTA | 1 | 8 |
| 48 x 120BTA | 2 | 10 |
| 48 x 144BTA | 2 | 10 |
| 48 x 168BTA | 2 | 12 |
| 48 x 192BTA | 2 | 14 |
| 48 x 216BTA | 2 | 14 |
| 60 x 120BTA | 2 | 10 |
| 60 x 144BTA | 2 | 12 |
| 60 x 168BTA | 2 | 12 |
| 60 x 192BTA | 2 | 14 |
| 60 x 216BTA | 2 | 16 |

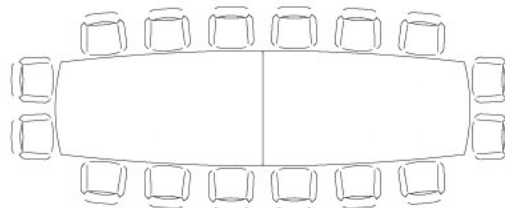

Boatshape Arc Ends 60x216

| ELLIPSE | | |
|--------------|-----------------------------|---|
| Size / Shape | Number of Tabletop Sections | Number of Chairs (based on 25" wide chairs) |
| 48 x 96EL | 1 | 6 |
| 48 x 120EL | 2 | 6 |
| 48 x 144EL | 2 | 8 |
| 48 x 168EL | 2 | 10 |
| 48 x 192EL | 2 | 10 |
| 48 x 216EL | 2 | 12 |
| 60 x 120EL | 2 | 8 |
| 60 x 144EL | 2 | 10 |
| 60 x 168EL | 2 | 10 |
| 60 x 192EL | 2 | 12 |
| 60 x 216EL | 2 | 14 |

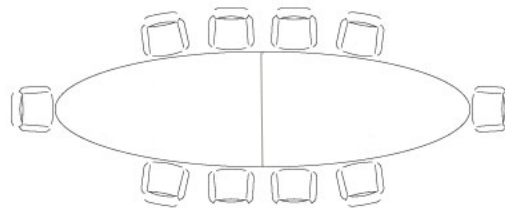

Ellipse 60x216

BOARDGAMES TABLES

TABLETOP SECTIONS AND SEATING LAYOUTS

| VIDEO CONFERENCE | | |
|-------------------------|-----------------------------|---|
| Size / Shape | Number of Tabletop Sections | Number of Chairs (based on 25" wide chairs) |
| 48 x 96VC | 1 | 8 |
| 48 x 120VC | 2 | 10 |
| 48 x 144VC | 2 | 10 |
| 48 x 168VC | 2 | 14 |
| 48 x 192VC | 2 | 14 |
| 48 x 216VC | 2 | 14 |
| 60 x 120VC | 2 | 10 |
| 60 x 144VC | 2 | 10 |
| 60 x 168VC | 2 | 14 |
| 60 x 192VC | 2 | 14 |
| 60 x 216VC | 2 | 16 |
| Standard with 12" Taper | | |

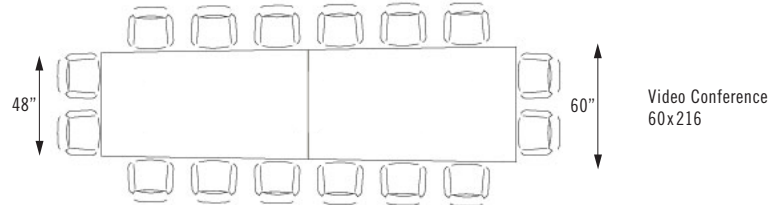

| VIDEO CONFERENCE ARC | | |
|-------------------------|-----------------------------|---|
| Size / Shape | Number of Tabletop Sections | Number of Chairs (based on 25" wide chairs) |
| 48 x 96VCA | 1 | 8 |
| 48 x 120VCA | 2 | 10 |
| 48 x 144VCA | 2 | 10 |
| 48 x 168VCA | 2 | 14 |
| 48 x 192VCA | 2 | 14 |
| 48 x 216VCA | 2 | 14 |
| 60 x 120VCA | 2 | 10 |
| 60 x 144VCA | 2 | 10 |
| 60 x 168VCA | 2 | 14 |
| 60 x 192VCA | 2 | 14 |
| 60 x 216VCA | 2 | 16 |
| Standard with 12" Taper | | |

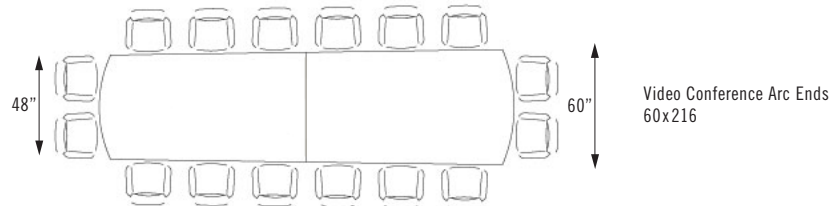

LARGER TABLE SIZES

Boardgames tabletops with a length of 108" to 216" and a width that doesn't exceed 60", will be made in 2 equal pieces. Boardgames tabletops with a length of 216" to 324" and a width that doesn't exceed 60", will be made in 3 equal pieces. All multiple piece tabletops are tight joint fastened. Bases standard in 22" width. 30" width is available, please contact factory for pricing.

WOOD FINISHES AND GRAIN DIRECTION

Finishes

Veneers and hardwood edge finishes are available in our 9 standard stains or stain-to-match which is never an upcharge.

Grain Direction

The grain on a single piece laminate or veneer boardroom tabletop will run lengthwise.

The grain on a 2-piece or more veneer top runs width-wise. The grain on a 2-piece or more laminate top runs length-wise.



BOARDGAMES TABLES POWER AND VOICE/DATA MODULES

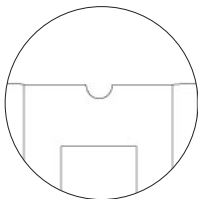
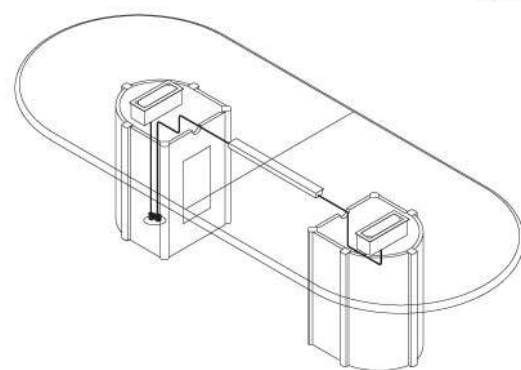
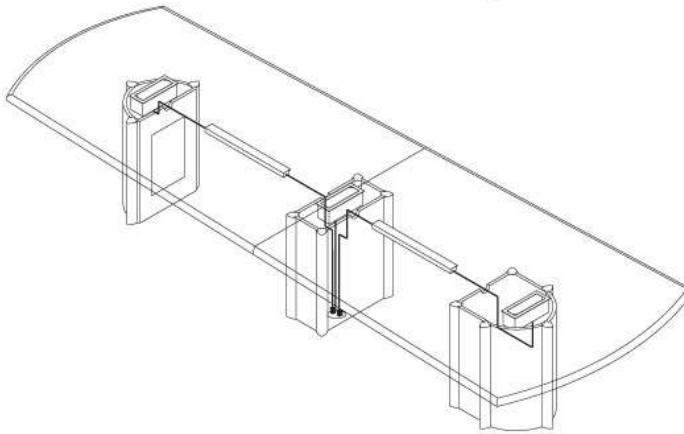
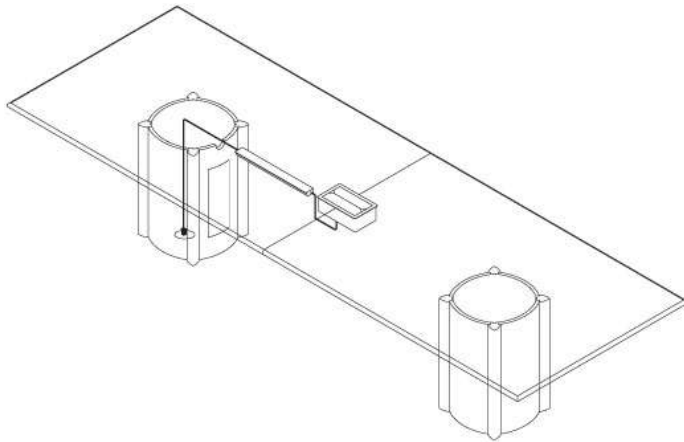

All Boardgames bases are standard with a touch latch removable door and a 3" cutout for wire pass-through at the top

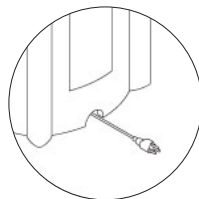

Optional cutout for wire pass-through at the bottom of Boardgames bases must be specified if required

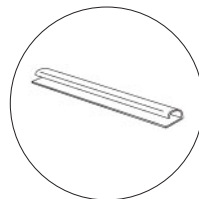

Tops are standard with 24" PVC under table wire manager between bases



BGDR Drum



BGHDR Half Drum

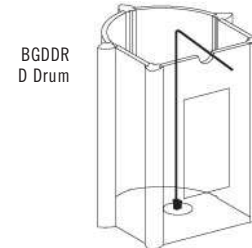

BGDDR D Drum



BGEL Ellipse

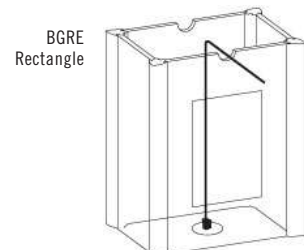

BGRE Rectangle

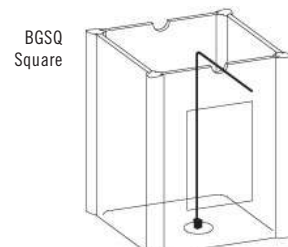

BGSQ Square

CONDUCTOR TABLES



PRODUCT CODE

2430 RE CT

Top Size

Width x Length

Top Shape

- D : Round
- SQ : Square
- RE : Rectangle
- RT : Racetrack
- B : Bullet
- H : Halfmoon
- TP : Trapezoid
- RC90 : Radius (*connector*)
- TC90 : Triangle (*connector*)
- CRC90 : Crescent (*connector*)
- BT : Boatshape
- BTA : Boatshape Arc

Series

Conductor

Base

- X : X-Base
- X4 : 4 Column X-Base
- T : T-Base
- T2 : Double Column T-Base
- T2D : T2 with Door
- C : C-Base

OPTIONS

FLIP TOP



CASTERS



FOLDING



FINISHES

LAMINATE

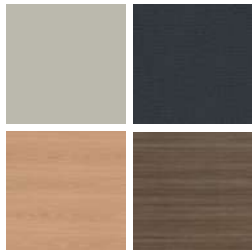

Select from 15 standard laminates or choose any standard Wilsonart, Nevamar, Formica, Arborite and Pionite matte finish laminates at no upcharge

VENEER

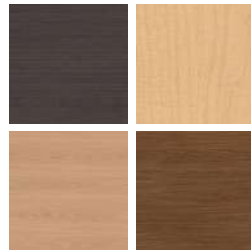

Select from one of our 9 standard wood stains or stain-to-match at no upcharge

BASE



Select from one of our 76 standard Spectone colors

EDGE



See Spectone Card or specfurniture.com/materials/finishes for a complete list of finish options and colors.

CONDUCTOR TABLES

HOW TO ORDER

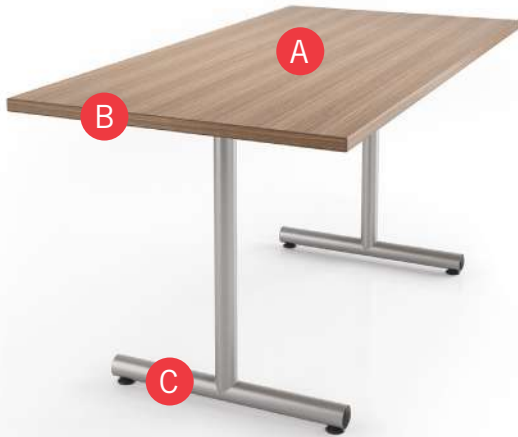

Specify Top Size (Width x Length) and Shape

- A** Specify Top Type and Finish
For Laminate Top: Manufacturer, Laminate Name, Laminate Code
For Veneer Top: Wood Stain
- B** Specify Edge Type, (for hardwood: Style), and Finish
PVC/2mm/Self Edge/Exposed Baltic Birch Plywood/Hardwood
- C** Specify Base Style and Finish

Optional: Flip Top, Fold, Bar Height, Hard Casters, Soft Casters, Wheelbarrow Wheels, Grommets, Seam Connectors, Modesty Panels, Adjustable Height, Power and Data Modules, Custom Solutions

Restrictions may apply. See price list tables below for more information.



| Top Size and Shape | Top Type and Finish | Edge Type, Style and Finish | Base Style and Finish |
|--------------------|---------------------------------|--|-----------------------|
| 24 x 72, Rectangle | Laminate, Arborite, Brown Sugar | Hardwood, HF, Custom Brown Sugar Stain | CT, Silver |

EDGE PROFILES

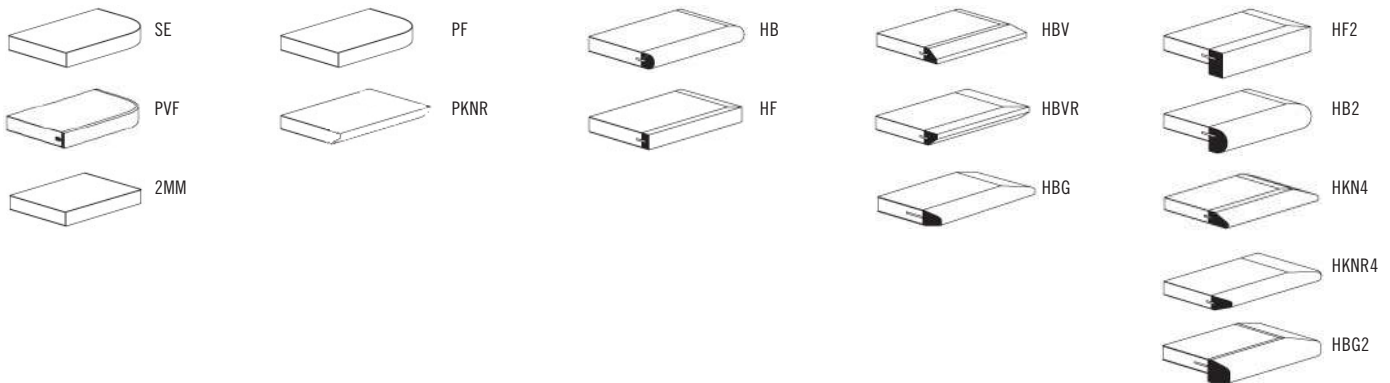



BACK TO CONTENTS

CONDUCTOR TABLES GENERAL PURPOSE



| MODEL | BASES | | TOP SPECIFICATIONS | | | | | | OPTIONS | | | LBS |
|---------------|-------|------|--------------------|--|--------------------|-------------------------------------|--------------------------------|-------------------------------------|---------------|-------------------|-------------------|-----|
| | Code | Qty. | For Laminate Top | | | For Veneer Top | | | FLIP TOP (FT) | HARD CASTERS (HC) | SOFT CASTERS (SC) | |
| | | | SE PVF 2MM | HF HB PKNR ¹ PF ¹ | HBV HBVR HBG | HF2 HB2 HKN4 HKNR4 HBG2 | HF HB HBV HBVR HBG | HF2 HB2 HKN4 HKNR4 HBG2 | | | | |
| <i>Round</i> | | | | | | | | | | | | |
| 24D | CX | 1 | 611 | 971 | 1008 | 1117 | 1176 | 1288 | 154 | 96 | 204 | 34 |
| 30D | CX | 1 | 715 | 1070 | 1117 | 1335 | 1280 | 1444 | 154 | 96 | 204 | 44 |
| 36D | CX | 1 | 814 | 1327 | 1418 | 1596 | 1650 | 1879 | 154 | 96 | 204 | 55 |
| 42D | CX | 1 | 1099 | 1675 | 1799 | 2064 | 2090 | 2403 | | | | 69 |
| | CX4 | 1 | 1253 | 1829 | 1953 | 2218 | 2244 | 2557 | | 96 | 204 | 77 |
| 48D | CX4 | 1 | 1276 | 2049 | 2184 | 2316 | 2790 | 3192 | | 96 | 204 | 93 |
| 54D | CX4 | 1 | 1566 | 2706 | 2916 | 3116 | 3352 | 3868 | | | | 111 |
| 60D | CX4 | 1 | 1614 | 2908 | 3132 | 3301 | 3987 | 4628 | | | | 130 |
| <i>Square</i> | | | | | | | | | | | | |
| 24 x 24SQ | CX | 1 | 642 | 837 | 874 | 942 | 992 | 1159 | 154 | 96 | 204 | 34 |
| 30 x 30SQ | CX | 1 | 749 | 891 | 942 | 1122 | 1056 | 1288 | 154 | 96 | 204 | 44 |
| 36 x 36SQ | CX | 1 | 832 | 1055 | 1117 | 1327 | 1335 | 1535 | 154 | 96 | 204 | 55 |
| 42 x 42SQ | CX4 | 1 | 1267 | 1590 | 1689 | 1789 | 1858 | 2131 | | 96 | 204 | 77 |
| 48 x 48SQ | CX4 | 1 | 1421 | 1704 | 1809 | 1856 | 2234 | 2587 | | 96 | 204 | 93 |
| 54 x 54SQ | CX4 | 1 | 1569 | 2193 | 2357 | 2547 | 2651 | 3108 | | | | 111 |
| 60 x 60SQ | CX4 | 1 | 1599 | 2299 | 2474 | 2665 | 3130 | 3683 | | | | 130 |

¹ Exposed Baltic Birch plywood edge (PKNR, PF) can only be specified on square tops up to 47-1/2" x 95-1/2". Clear finish only.



30D-CX



42D-CX4

STANDARD FEATURES

- Select from 15 standard laminates or choose any standard Wilsonart, Nevamar, Formica, Arborite and Pionite matte finish laminates at no upcharge. For other laminate please contact the factory for pricing.
- 9 standard veneer and hardwood edge stains. Stain-to-match available at no upcharge.
- Bases available in any Spectone color.
- Standard table height 29".
- All bases are standard with floor leveling glides.

OPTIONS

- Custom heights available.
- For applicable Power & Data modules, please see Table Accessories Price List.

HOW TO ORDER

1. Select Model
2. Select Base
3. Select Edge Style
4. Select Options
5. Select Top Finish
6. Select Edge Finish
7. Select Base Finish

Example: 24D - CX - PVF -





CONDUCTOR TABLES GENERAL PURPOSE

| MODEL | BASES | | TOP SPECIFICATIONS | | | | | | OPTIONS | | | | LBS | |
|------------------|-------|------|--------------------|--|--------------------|-------------------------------------|--------------------------------|-------------------------------------|---------------|------------|---------|-----|-----------|-------------|
| | Code | Qty. | For Laminate Top | | | For Veneer Top | | | FLIP TOP (FT) | FOLD* (FL) | CASTERS | | | WHEELS (WB) |
| | | | SE PVF 2MM | HF HB PKNR ¹ PF ¹ | HBV HBVR HBG | HF2 HB2 HKN4 HKNR4 HBG2 | HF HB HBV HBVR HBG | HF2 HB2 HKN4 HKNR4 HBG2 | | | | | HARD (HC) | |
| <i>Rectangle</i> | | | | | | | | | | | | | | |
| 24 x 30RE | CX | 1 | 738 | 870 | 919 | 987 | 1040 | 1171 | 154 | | | | | 43 |
| | CT | 2 | 814 | 946 | 995 | 1063 | 1116 | 1247 | 310 | | 96 | 204 | 95 | 52 |
| 24 x 36RE | CX | 1 | 738 | 870 | 919 | 987 | 1040 | 1171 | 154 | | | | | 43 |
| | CT | 2 | 814 | 946 | 995 | 1063 | 1116 | 1247 | 310 | | 96 | 204 | 95 | 52 |
| 24 x 42RE | CT | 2 | 879 | 1094 | 1150 | 1251 | 1312 | 1493 | 310 | | 96 | 204 | 95 | 60 |
| 24 x 48RE | CT | 2 | 879 | 1094 | 1150 | 1251 | 1312 | 1493 | 310 | | 96 | 204 | 95 | 60 |
| 24 x 54RE | CT | 2 | 940 | 1253 | 1323 | 1439 | 1526 | 1748 | 310 | | 96 | 204 | 95 | 68 |
| 24 x 60RE | CT | 2 | 940 | 1253 | 1323 | 1439 | 1526 | 1748 | 310 | 297 | 96 | 204 | 95 | 68 |
| 24 x 66RE | CT | 2 | 1088 | 1465 | 1551 | 1693 | 1784 | 2056 | 310 | 297 | 96 | 204 | 95 | 77 |
| 24 x 72RE | CT | 2 | 1088 | 1465 | 1551 | 1693 | 1784 | 2056 | 310 | 297 | 96 | 204 | 95 | 77 |
| 30 x 36RE | CX | 1 | 832 | 987 | 1041 | 1130 | 1192 | 1350 | 154 | | | | | 49 |
| | CT | 2 | 908 | 1063 | 1117 | 1206 | 1268 | 1426 | 310 | | 96 | 204 | 95 | 58 |
| 30 x 42RE | CT | 2 | 930 | 1224 | 1291 | 1407 | 1493 | 1713 | 310 | | 96 | 204 | 95 | 68 |
| 30 x 48RE | CT | 2 | 930 | 1224 | 1291 | 1407 | 1493 | 1713 | 310 | | 96 | 204 | 95 | 68 |
| 30 x 54RE | CT | 2 | 991 | 1391 | 1478 | 1644 | 1742 | 2018 | 310 | | 96 | 204 | 95 | 79 |
| 30 x 60RE | CT | 2 | 991 | 1391 | 1478 | 1644 | 1742 | 2018 | 310 | 297 | 96 | 204 | 95 | 79 |
| 30 x 66RE | CT | 2 | 1167 | 1492 | 1598 | 1765 | 1861 | 2166 | 310 | 297 | 96 | 204 | 95 | 89 |
| 30 x 72RE | CT | 2 | 1225 | 1648 | 1755 | 1971 | 2084 | 2420 | 310 | 297 | 96 | 204 | 95 | 89 |
| 30 x 78RE | CT | 2 | 1453 | 1828 | 1955 | 2206 | 2338 | 2724 | 310 | 297 | 96 | 204 | | 100 |
| 30 x 84RE | CT | 2 | 1453 | 1828 | 1955 | 2206 | 2338 | 2724 | 310 | 297 | 96 | 204 | | 100 |
| 30 x 90RE | CT | 2 | 1475 | 2053 | 2206 | 2438 | 2594 | 3034 | | 297 | 96 | 204 | 95 | 110 |
| 30 x 96RE | CT | 2 | 1475 | 2053 | 2206 | 2438 | 2594 | 3034 | | 297 | 96 | 204 | 95 | 110 |

*Folding tables available with PVC Flat (PVF) edge only.

¹ Exposed Baltic Birch plywood edge (PKNR, PF) can only be specified on tops up to 47-1/2" x 95-1/2". Clear finish only.



STANDARD FEATURES

- Select from 15 standard laminates or choose any standard Wilsonart, Nevamar, Formica, Arborite and Pionite matte finish laminates at no upcharge. For other laminate please contact the factory for pricing.
- 9 standard veneer and hardwood edge stains. Stain-to-match available at no upcharge.
- Bases available in any Spectone color.
- Standard table height 29".
- All bases are standard with floor leveling glides.

OPTIONS

- Custom heights available.
- For applicable Power & Data modules, please see Table Accessories Price List.

HOW TO ORDER

1. Select Model
2. Select Base
3. Select Edge Style
4. Select Options
5. Select Top Finish
6. Select Edge Finish
7. Select Base Finish

Example: 2430RE - CX - PVF -





BACK TO CONTENTS

CONDUCTOR TABLES GENERAL PURPOSE

| MODEL | BASES | | TOP SPECIFICATIONS | | | | | | OPTIONS | | | | LBS | |
|------------------|-------|------|--------------------|--|--------------------|-------------------------------------|--------------------------------|-------------------------------------|---------------|------------|---------|-----|-----------|-------------|
| | Code | Qty. | For Laminate Top | | | For Veneer Top | | | FLIP TOP (FT) | FOLD* (FL) | CASTERS | | | WHEELS (WB) |
| | | | SE PVF 2MM | HF HB PKNR ¹ PF ¹ | HBV HBVR HBG | HF2 HB2 HKN4 HKNR4 HBG2 | HF HB HBV HBVR HBG | HF2 HB2 HKN4 HKNR4 HBG2 | | | | | HARD (HC) | |
| <i>Rectangle</i> | | | | | | | | | | | | | | |
| 36 x 42RE | CT | 2 | 1032 | 1253 | 1337 | 1452 | 1542 | 1773 | 310 | | 96 | 204 | 95 | 77 |
| 36 x 48RE | CT | 2 | 1057 | 1369 | 1460 | 1598 | 1689 | 1960 | 310 | | 96 | 204 | 95 | 77 |
| 36 x 60RE | CT | 2 | 1156 | 1590 | 1700 | 1876 | 1987 | 2325 | 310 | 297 | 96 | 204 | 95 | 89 |
| 36 x 66RE | CT | 2 | 1246 | 1696 | 1823 | 2016 | 2138 | 2509 | | 297 | 96 | 204 | 95 | 102 |
| | CT2 | 2 | 1432 | 1882 | 2009 | 2202 | 2324 | 2695 | | 597 | 96 | 204 | | 112 |
| 36 x 72RE | CT | 2 | 1285 | 1755 | 1876 | 2155 | 2291 | 2692 | | 297 | 96 | 204 | 95 | 102 |
| | CT2 | 2 | 1471 | 1941 | 2062 | 2341 | 2477 | 2878 | | 597 | 96 | 204 | | 112 |
| 36 x 78RE | CT | 2 | 1626 | 2129 | 2287 | 2530 | 2688 | 3161 | | | 96 | 204 | 95 | 115 |
| | CT2 | 2 | 1812 | 2315 | 2473 | 2716 | 2874 | 3347 | | 597 | 96 | 204 | | 125 |
| 36 x 84RE | CT | 2 | 1626 | 2129 | 2287 | 2530 | 2688 | 3161 | | | 96 | 204 | 95 | 115 |
| | CT2 | 2 | 1812 | 2315 | 2473 | 2716 | 2874 | 3347 | | 597 | 96 | 204 | | 125 |
| 36 x 90RE | CT | 2 | 1633 | 2350 | 2530 | 2813 | 2995 | 3519 | | | 96 | 204 | 95 | 127 |
| | CT2 | 2 | 1819 | 2536 | 2716 | 2999 | 3181 | 3705 | | 597 | 96 | 204 | | 137 |
| 36 x 96RE | CT | 2 | 1633 | 2350 | 2530 | 2813 | 2995 | 3519 | | | 96 | 204 | 95 | 127 |
| | CT2 | 2 | 1819 | 2536 | 2716 | 2999 | 3181 | 3705 | | 597 | 96 | 204 | | 137 |
| 42 x 78RE | CT2 | 2 | 2060 | 2492 | 2665 | 3083 | 3220 | 3768 | | 597 | 96 | 204 | | 139 |
| | CT2D | 2 | 3292 | 3724 | 3897 | 4315 | 4452 | 5000 | | | | | | 153 |
| 42 x 84RE | CT2 | 2 | 2060 | 2492 | 2665 | 3083 | 3220 | 3768 | | 597 | 96 | 204 | | 139 |
| | CT2D | 2 | 3292 | 3724 | 3897 | 4315 | 4452 | 5000 | | | | | | 153 |

*Folding tables available with PVC Flat (PVF) edge only.

¹ Exposed Baltic Birch plywood edge (PKNR, PF) can only be specified on tops up to 47-1/2" x 95-1/2". Clear finish only.



2448RE-CT

STANDARD FEATURES

- Select from 15 standard laminates or choose any standard Wilsonart, Nevamar, Formica, Arborite and Pionite matte finish laminates at no upcharge. For other laminate please contact the factory for pricing.
- 9 standard veneer and hardwood edge stains. Stain-to-match available at no upcharge.
- Bases available in any Spectone color.
- Standard table height 29".
- All bases are standard with floor leveling glides.

OPTIONS

- Custom heights available.
- For applicable Power & Data modules, please see Table Accessories Price List.

HOW TO ORDER

1. Select Model
2. Select Base
3. Select Edge Style
4. Select Options
5. Select Top Finish
6. Select Edge Finish
7. Select Base Finish

Example: 3642RE - CT - PVF -





BACK TO CONTENTS

CONDUCTOR TABLES GENERAL PURPOSE

| MODEL | BASES | | TOP SPECIFICATIONS | | | | | | OPTIONS | | | LBS | |
|------------------|-------|------|--------------------|-------|--------------|--------------------|--------------------|--------------------|---------------|---------|-----------|-----------|-------------|
| | Code | Qty. | For Laminate Top | | | For Veneer Top | | | FLIP TOP (FT) | CASTERS | | | WHEELS (WB) |
| | | | SE PVF 2MM | HF HB | HBV HBVR HBG | HF2 HB2 HKNR4 HBG2 | HF HB HBV HBVR HBG | HF2 HB2 HKNR4 HBG2 | | | HARD (HC) | SOFT (SC) | |
| <i>Racetrack</i> | | | | | | | | | | | | | |
| 36 x 54RT | CT | 2 | 1213 | 1784 | 1917 | 2155 | 2253 | 2602 | 310 | 96 | 204 | 95 | 89 |
| | CT2 | 2 | 1399 | 1970 | 2103 | 2341 | 2439 | 2788 | | 96 | 204 | 95 | 99 |
| 36 x 60RT | CT | 2 | 1213 | 1784 | 1917 | 2155 | 2253 | 2602 | 310 | 96 | 204 | 95 | 89 |
| | CT2 | 2 | 1399 | 1970 | 2103 | 2341 | 2439 | 2788 | | 96 | 204 | 95 | 99 |
| 36 x 66RT | CT | 2 | 1374 | 1971 | 2115 | 2370 | 2594 | 3030 | 310 | 96 | 204 | 95 | 102 |
| | CT2 | 2 | 1560 | 2157 | 2301 | 2556 | 2780 | 3216 | | 96 | 204 | 95 | 112 |
| 36 x 72RT | CT | 2 | 1374 | 1971 | 2115 | 2370 | 2594 | 3030 | 310 | 96 | 204 | 95 | 102 |
| | CT2 | 2 | 1560 | 2157 | 2301 | 2556 | 2780 | 3216 | | 96 | 204 | 95 | 112 |
| 36 x 78RT | CT | 2 | 1644 | 2402 | 2579 | 2964 | 3045 | 3553 | | 96 | 204 | 95 | 115 |
| | CT2 | 2 | 1830 | 2588 | 2765 | 3150 | 3231 | 3739 | | 96 | 204 | 95 | 125 |
| 36 x 84RT | CT | 2 | 1644 | 2402 | 2579 | 2964 | 3045 | 3553 | | 96 | 204 | 95 | 115 |
| | CT2 | 2 | 1830 | 2588 | 2765 | 3150 | 3231 | 3739 | | 96 | 204 | 95 | 125 |
| 36 x 90RT | CT | 2 | 1648 | 2659 | 2870 | 3301 | 3402 | 3981 | | 96 | 204 | 95 | 127 |
| | CT2 | 2 | 1834 | 2845 | 3056 | 3487 | 3588 | 4167 | | 96 | 204 | 95 | 137 |
| 36 x 96RT | CT | 2 | 1648 | 2659 | 2870 | 3301 | 3402 | 3981 | | 96 | 204 | 95 | 127 |
| | CT2 | 2 | 1834 | 2845 | 3056 | 3487 | 3588 | 4167 | | 96 | 204 | 95 | 137 |
| 42 x 78RT | CT2 | 2 | 2075 | 2792 | 3009 | 3445 | 3550 | 4134 | | 96 | 204 | 95 | 154 |
| | CT2D | 2 | 3307 | 4024 | 4241 | 4677 | 4782 | 5366 | | | | | 168 |
| 42 x 84RT | CT2 | 2 | 2075 | 2792 | 3009 | 3445 | 3550 | 4134 | | 96 | 204 | 95 | 154 |
| | CT2D | 2 | 3307 | 4024 | 4241 | 4677 | 4782 | 5366 | | | | | 168 |
| 48 x 78RT | CT2 | 2 | 2078 | 3100 | 3346 | 3732 | 3973 | 4637 | | 96 | 204 | 95 | 154 |
| | CT2D | 2 | 3310 | 4332 | 4578 | 4964 | 5205 | 5869 | | | | | 168 |
| 48 x 84RT | CT2 | 2 | 2078 | 3100 | 3346 | 3732 | 3973 | 4637 | | 96 | 204 | 95 | 154 |
| | CT2D | 2 | 3310 | 4332 | 4578 | 4964 | 5205 | 5869 | | | | | 168 |



2448RE-CT

STANDARD FEATURES

- Select from 15 standard laminates or choose any standard Wilsonart, Nevamar, Formica, Arborite and Pionite matte finish laminates at no upcharge. For other laminate please contact the factory for pricing.
- 9 standard veneer and hardwood edge stains. Stain-to-match available at no upcharge.
- Bases available in any Spectone color.
- Standard table height 29".
- All bases are standard with floor leveling glides.

OPTIONS

- Custom heights available.
- For applicable Power & Data modules, please see Table Accessories Price List.

HOW TO ORDER

1. Select Model
2. Select Base
3. Select Edge Style
4. Select Options
5. Select Top Finish
6. Select Edge Finish
7. Select Base Finish

Example: 3654RT - CT - PVF -





BACK TO CONTENTS

CONDUCTOR TABLES GENERAL PURPOSE



| MODEL | BASES | | TOP SPECIFICATIONS | | | | | | OPTIONS | | | LBS | |
|-----------------------------|--------------|------|--------------------|-------|--------------|-------------------------|--------------------|-------------------------|---------------|---------|-----------|-----------|-------------|
| | Code | Qty. | For Laminate Top | | | For Veneer Top | | | FLIP TOP (FT) | CASTERS | | | WHEELS (WB) |
| | | | SE PVF 2MM | HF HB | HBV HBVR HBG | HF2 HB2 HKN4 HKNR4 HBG2 | HF HB HBV HBVR HBG | HF2 HB2 HKN4 HKNR4 HBG2 | | | HARD (HC) | SOFT (SC) | |
| <i>Bullet</i> | | | | | | | | | | | | | |
| 30 x 54B | CT | 2 | 1112 | 1681 | 1800 | 2008 | 2070 | 2414 | 310 | 96 | 204 | 95 | 79 |
| 30 x 60B | CT | 2 | 1112 | 1681 | 1800 | 2008 | 2070 | 2414 | 310 | 96 | 204 | 95 | 79 |
| 36 x 54B | CT | 2 | 1235 | 2192 | 2361 | 2666 | 2708 | 3141 | | 96 | 204 | 95 | 89 |
| 36 x 60B | CT | 2 | 1235 | 2192 | 2361 | 2666 | 2708 | 3141 | | 96 | 204 | 95 | 89 |
| 36 x 72B | CT | 2 | 1373 | 2431 | 2618 | 2944 | 3133 | 3677 | | 96 | 204 | 95 | 102 |
| <i>Halfmoon</i> | | | | | | | | | | | | | |
| 24 x 48H | CC | 2 | 813 | 1327 | 1456 | 1612 | 1739 | 2031 | | 96 | 204 | | 56 |
| | CT | 2 | 897 | 1411 | 1540 | 1696 | 1823 | 2115 | 310 | 96 | 204 | 95 | 60 |
| 30 x 60H | CC | 2 | 1028 | 1793 | 1970 | 2146 | 2366 | 2783 | | 96 | 204 | | 75 |
| | CT | 2 | 1112 | 1877 | 2054 | 2230 | 2450 | 2867 | 310 | 96 | 204 | 95 | 79 |
| 36 x 72H | CT | 2 | 1373 | 2417 | 2648 | 2864 | 3221 | 3785 | | | | 95 | 102 |
| <i>Trapezoid</i> | | | | | | | | | | | | | |
| 30 x 60TP | CC | 2 | 1028 | 1499 | 1609 | 1798 | 1853 | 2172 | | 96 | 204 | | 75 |
| | CT | 2 | 1112 | 1583 | 1693 | 1882 | 1937 | 2256 | | 96 | 204 | | 79 |
| 36 x 72TP | CC | 2 | 1289 | 1928 | 2072 | 2400 | 2482 | 2942 | | 96 | 204 | | 98 |
| | CT | 2 | 1373 | 2012 | 2156 | 2484 | 2566 | 3026 | | 96 | 204 | | 102 |
| <i>Radius (connector)</i> | | | | | | | | | | | | | |
| 24 x 24 | 24RC90 | - | 395 | 717 | 810 | 929 | 952 | 1140 | | | | | 17 |
| 30 x 30 | 30RC90 | - | 504 | 948 | 1066 | 1195 | 1263 | 1515 | | | | | 27 |
| <i>Crescent (connector)</i> | | | | | | | | | | | | | |
| 30 x 36 | 3036CRC90-CT | 1 | 833 | 1519 | 1606 | 1674 | 1892 | 2131 | | | | | 45 |
| 36 x 42 | 3642CRC90-CT | 1 | 1196 | 1840 | 1959 | 2048 | 2348 | 2672 | | | | | 58 |



2448RE-CT

STANDARD FEATURES

- Select from 15 standard laminates or choose any standard Wilsonart, Nevamar, Formica, Arborite and Pionite matte finish laminates at no upcharge. For other laminate please contact the factory for pricing.
- 9 standard veneer and hardwood edge stains. Stain-to-match available at no upcharge.
- Bases available in any Spectone color.
- Standard table height 29".
- All bases are standard with floor leveling glides.

OPTIONS

- Custom heights available.
- For applicable Power & Data modules, please see Table Accessories Price List.

HOW TO ORDER

1. Select Model
2. Select Base
3. Select Edge Style
4. Select Options
5. Select Top Finish
6. Select Edge Finish
7. Select Base Finish

Example: 3054B - CT - PVF -





CONDUCTOR TABLES TRAINING



| | Code | Qty. | For Laminate Top | | | For Veneer Top | | FLIP TOP (FT) | FOLD (FL) | CASTERS | | WHEELS (WB) | |
|-----------------------------|--------|------|------------------|------|------|----------------|------|---------------|-----------|-----------|-----------|-------------|----|
| | | | PVF 2MM | HF | HKN1 | HF | HKN1 | | | HARD (HC) | SOFT (SC) | | |
| <i>Rectangle</i> | | | | | | | | | | | | | |
| 18 X 42RE | CC | 2 | 750 | 940 | 1072 | 1130 | 1283 | | | 96 | 204 | 95 | 48 |
| 18 X 48RE | CC | 2 | 750 | 940 | 1072 | 1130 | 1283 | | | 96 | 204 | 95 | 48 |
| 18 X 54RE | CC | 2 | 795 | 1010 | 1167 | 1228 | 1409 | | | 96 | 204 | 95 | 54 |
| 18 X 60RE | CC | 2 | 795 | 1010 | 1167 | 1228 | 1409 | | 297 | 96 | 204 | 95 | 54 |
| 18 X 66RE | CC | 2 | 856 | 1169 | 1355 | 1442 | 1664 | | 297 | 96 | 204 | 95 | 60 |
| 18 X 72RE | CC | 2 | 856 | 1169 | 1355 | 1442 | 1664 | | 297 | 96 | 204 | 95 | 60 |
| 24 X 42RE | CC | 2 | 795 | 1010 | 1167 | 1228 | 1409 | | | 96 | 204 | 95 | 56 |
| 24 X 48RE | CC | 2 | 795 | 1010 | 1167 | 1228 | 1409 | | | 96 | 204 | 95 | 56 |
| 24 X 54RE | CC | 2 | 856 | 1169 | 1355 | 1442 | 1664 | | | 96 | 204 | 95 | 64 |
| 24 X 60RE | CC | 2 | 856 | 1169 | 1355 | 1442 | 1664 | | 297 | 96 | 204 | 95 | 64 |
| 24 X 66RE | CC | 2 | 1004 | 1381 | 1609 | 1700 | 1972 | | 297 | 96 | 204 | 95 | 73 |
| 24 X 72RE | CC | 2 | 1004 | 1381 | 1609 | 1700 | 1972 | | 297 | 96 | 204 | 95 | 73 |
| 30 X 42RE | CC | 2 | 846 | 1140 | 1323 | 1409 | 1629 | | | 96 | 204 | 95 | 64 |
| 30 X 48RE | CC | 2 | 846 | 1140 | 1323 | 1409 | 1629 | | | 96 | 204 | 95 | 64 |
| 30 X 54RE | CC | 2 | 907 | 1307 | 1560 | 1658 | 1934 | | | 96 | 204 | 95 | 75 |
| 30 X 60RE | CC | 2 | 907 | 1307 | 1560 | 1658 | 1934 | | 297 | 96 | 204 | 95 | 75 |
| 30 X 66RE | CC | 2 | 1083 | 1408 | 1681 | 1777 | 2082 | | 297 | 96 | 204 | 95 | 85 |
| 30 X 72RE | CC | 2 | 1141 | 1564 | 1887 | 2000 | 2336 | | 297 | 96 | 204 | 95 | 85 |
| <i>Radius (connector)</i> | | | | | | | | | | | | | |
| 24, 90° | 24RC90 | - | 395 | 717 | 929 | 952 | 1140 | | | | | | 16 |
| 30, 90° | 30RC90 | - | 504 | 948 | 1195 | 1263 | 1515 | | | | | | 23 |
| 24, 30° | 24RC30 | - | 361 | 684 | 896 | 918 | 1107 | | | | | | 10 |
| 30, 30° | 30RC30 | - | 474 | 917 | 1164 | 1232 | 1486 | | | | | | 16 |
| <i>Triangle (connector)</i> | | | | | | | | | | | | | |
| 24, 90° | 24TC90 | - | 395 | 717 | 929 | 952 | 1140 | | | | | | 16 |
| 30, 90° | 30TC90 | - | 504 | 948 | 1195 | 1263 | 1515 | | | | | | 23 |
| 24, 30° | 24TC30 | - | 361 | 684 | 896 | 918 | 1107 | | | | | | 10 |
| 30, 30° | 30TC30 | - | 474 | 917 | 1164 | 1232 | 1486 | | | | | | 16 |

*Folding tables available with PVC Flat (PVF) edge only.

STANDARD FEATURES

- Select from 15 standard laminates or choose any standard Wilsonart, Nevamar, Formica, Arborite and Pionite matte finish laminates at no upcharge. For other laminate please contact the factory for pricing.
- 9 standard veneer and hardwood edge stains. Stain-to-match available at no upcharge.
- Bases available in any Spectone color.
- Standard table height 29".
- All bases are standard with floor leveling glides.
- Training tables without a wire management trough are provided with inserts to attach a trough later if required.

OPTIONS

- Custom heights available.
- For applicable Power & Data modules, please see Table Accessories Price List.

HOW TO ORDER

1. Select Model
2. Select Base
3. Select Edge Style
4. Select Options
5. Select Top Finish
6. Select Edge Finish
7. Select Base Finish

Example: 1842RE - CC - PVF -



COOPER TABLES



PRODUCT CODE

2448 RE - COOPER 64

| | | | |
|---|--|-------------------------------------|---|
| <p>Top Size Width x Length or Diameter</p> | <p>Top Shape D : Round SQ : Square RE : Rectangle</p> | <p>Collection Cooper</p> | <p>Series 61 : Dwight 62 : Bala 64 : Huntsville 67 : Midland</p> |
|---|--|-------------------------------------|---|

FINISHES

LAMINATE

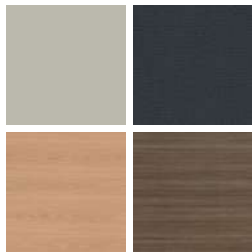

Select from 15 standard laminates or choose any standard Wilsonart, Nevamar, Formica, Arborite and Pionite matte finish laminates at no upcharge

VENEER

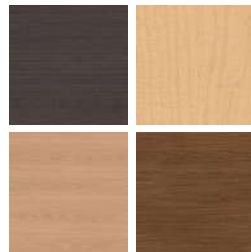

Select from one of our 9 standard wood stains or stain-to-match at no upcharge

BASE



Select from one of our 76 standard Spectone colors

EDGE



See Spectone Card or specfurniture.com/materials/finishes for a complete list of finish options and colors.



COOPER TABLES

HOW TO ORDER

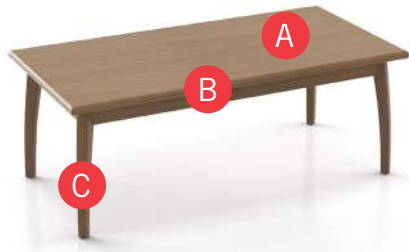

Specify Top Size (Width x Length) and Shape

- A** Specify Top Type and Finish
For Laminate Top: Manufacturer, Laminate Name, Laminate Code
For Veneer Top: Wood Stain
- B** Specify Edge Type, (for hardwood: Style), and Finish
PVC/2mm/Self Edge/Exposed Baltic Birch Plywood/Hardwood
- C** Specify Base Style, Wood/Metal Base Finish, Wood Table Skirt Finish
For Wood: Wood Stain
For Metal: RAL Finish

| Top Size and Shape | Top Type and Finish | Edge Type and Finish | Base Style, Base Finish, Table Skirt Finish |
|--------------------|---|---------------------------------|--|
| 24 x 48, Rectangle | Laminate, Wilsonart, Studio Teak 7960K-18 | Hardwood, HB, Studio Teak Stain | COOPER64, Wood, Studio Teak Stain, Studio Teak Stain |



EDGE PROFILES

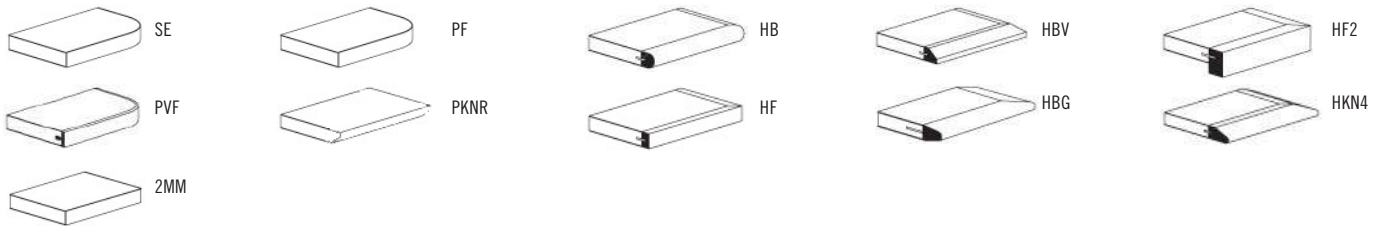



COOPER TABLES

OCCASIONAL AND LOUNGE

| MODEL | BASES | | TOP SPECIFICATIONS | | | | | | OPTIONS | LBS |
|------------------|-----------------|------|--------------------|-------------------|-----------------|----------------|------|------|---------|-----|
| | Code | Qty. | For Laminate Top | | | For Veneer Top | | | | |
| | | | SE | HF | HBV | HF2 | HF | HF2 | | |
| | | | PVF | HB | HBG | HKN4 | HB | HKN4 | | |
| | | | 2MM | PKNR ¹ | PF ¹ | | HBV | HBG | | |
| <i>Round</i> | | | | | | | | | | |
| 22D | COOPER61 | 1 | 799 | 1159 | 1196 | 1305 | 1364 | 1476 | | 45 |
| | COOPER62 | 1 | 968 | 1328 | 1365 | 1474 | 1533 | 1645 | | 43 |
| | COOPER64 | 1 | 1056 | 1416 | 1453 | 1562 | 1621 | 1733 | | 43 |
| | COOPER67 | 1 | 1056 | 1416 | 1453 | 1562 | 1621 | 1733 | | 43 |
| <i>Square</i> | | | | | | | | | | |
| 18 x 18SQ | COOPER61 | 1 | 627 | 833 | 870 | 938 | 988 | 1155 | | 40 |
| | COOPER62 | 1 | 802 | 1008 | 1045 | 1113 | 1163 | 1330 | | 38 |
| | COOPER64 | 1 | 890 | 1096 | 1133 | 1201 | 1251 | 1418 | | 38 |
| | COOPER67 | 1 | 890 | 1096 | 1133 | 1201 | 1251 | 1418 | | 38 |
| 24 x 24SQ | COOPER61 | 1 | 638 | 833 | 870 | 938 | 988 | 1155 | | 47 |
| | COOPER62 | 1 | 813 | 1008 | 1045 | 1113 | 1163 | 1330 | | 45 |
| | COOPER64 | 1 | 901 | 1096 | 1133 | 1201 | 1251 | 1418 | | 45 |
| | COOPER67 | 1 | 901 | 1096 | 1133 | 1201 | 1251 | 1418 | | 45 |
| 30 x 30SQ | COOPER61 | 1 | 745 | 887 | 938 | 1118 | 1052 | 1284 | | 57 |
| | COOPER62 | 1 | 920 | 1062 | 1113 | 1293 | 1227 | 1459 | | 55 |
| | COOPER64 | 1 | 1008 | 1150 | 1201 | 1381 | 1315 | 1547 | | 55 |
| | COOPER67 | 1 | 1008 | 1150 | 1201 | 1381 | 1315 | 1547 | | 55 |
| 36 x 36SQ | COOPER61 | 1 | 828 | 1051 | 1113 | 1323 | 1331 | 1531 | | 68 |
| | COOPER62 | 1 | 1003 | 1226 | 1288 | 1498 | 1506 | 1706 | | 66 |
| | COOPER64 | 1 | 1091 | 1314 | 1376 | 1586 | 1594 | 1794 | | 66 |
| | COOPER67 | 1 | 1091 | 1314 | 1376 | 1586 | 1594 | 1794 | | 66 |
| <i>Rectangle</i> | | | | | | | | | | |
| 24 x 48RE | COOPER61 | 1 | 799 | 1014 | 1070 | 1171 | 1232 | 1413 | | 64 |
| | COOPER62 | 1 | 974 | 1189 | 1245 | 1346 | 1407 | 1588 | | 62 |
| | COOPER64 | 1 | 1062 | 1277 | 1333 | 1434 | 1495 | 1676 | | 62 |
| | COOPER67 | 1 | 1062 | 1277 | 1333 | 1434 | 1495 | 1676 | | 62 |

¹ Exposed Baltic Birch plywood edge (PKNR, PF) can only be specified on square and rectangle tops up to 47-1/2" x 95-1/2". Clear finish only.



STANDARD FEATURES

- Select from 15 standard laminates or choose any standard Wilsonart, Nevamar, Formica, Arborite and Pionite matte finish laminates at no upcharge. For other laminate please contact the factory for pricing.
- 9 standard veneer, table skirts and hardwood edge stains. Stain-to-match available at no upcharge.
- Cooper Dwight table base available in any Spectone color.
- Standard table height 18".
- All bases are standard with floor leveling glides.

OPTIONS

- Custom heights available.

HOW TO ORDER

1. Select Model
2. Select Base
3. Select Edge Style
4. Select Top Finish
5. Select Edge Finish
6. Select Base Finish

Example: 22D - COOPER61 - PVF



DANI TABLES



PRODUCT CODE

2430 RE DANI O

Top Size
Width x Length

Top Shape
D : Round
SQ : Square
RE : Rectangle

Series
Dani

Base
N/A : Round Post Leg
O : Oval Post Leg
OM : O with Magazine Shelf

OPTIONS

ROUND LEG



OVAL LEG



MAGAZINE SHELF



FINISHES

LAMINATE



Select from 15 standard laminates or choose any standard Wilsonart, Nevamar, Formica, Arborite and Pionite matte finish laminates at no upcharge

VENEER



Select from one of our 9 standard wood stains or stain-to-match at no upcharge

BASE



Select from one of our 76 standard Spectone colors

EDGE



2MM

PVC

SE

Hard Wood

Exposed Baltic Birch Plywood

See Spectone Card or specfurniture.com/materials/finishes for a complete list of finish options and colors.



DANI TABLES

HOW TO ORDER

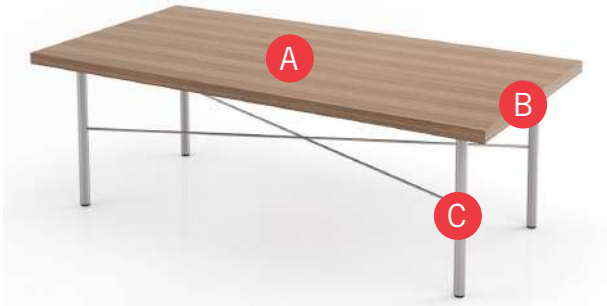

Specify Top Size (Width x Length) and Shape

- A** Specify Top Type and Finish
For Laminate Top: Manufacturer, Laminate Name, Laminate Code
For Veneer Top: Wood Stain
- B** Specify Edge Type, (for hardwood: Style), and Finish
PVC/2mm/Self Edge/Exposed Baltic Birch Plywood/Hardwood
- C** Specify Base Style and Finish

Optional: Power and Data Modules, Custom Solutions

| Top Size and Shape | Top Type and Finish | Edge Type, Style and Finish | Base Style and Finish |
|--------------------|---------------------------------|--|-----------------------|
| 2448, Rectangle | Laminate, Arborite, Brown Sugar | Hardwood, HF, Custom Brown Sugar Stain | DANI18, Silver |



EDGE PROFILES

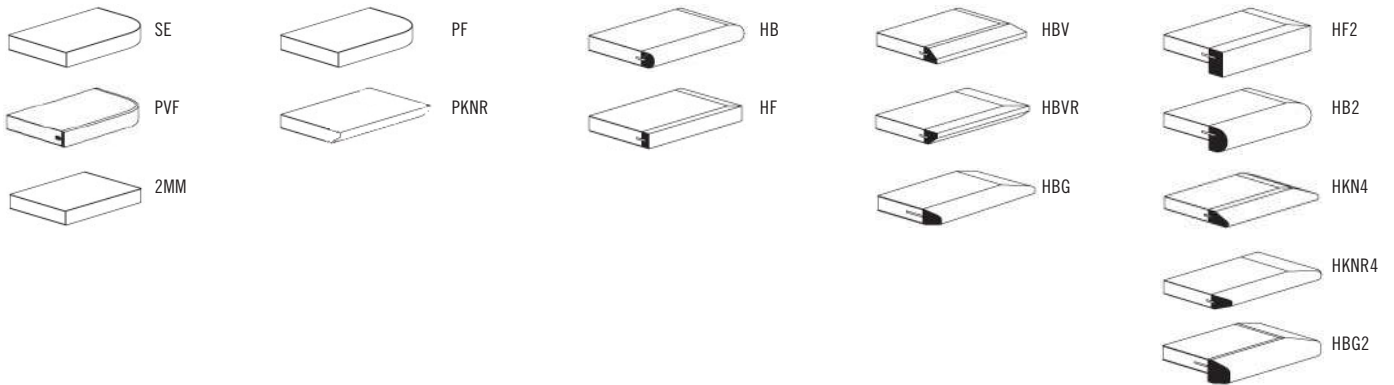



DANI TABLES

OCCASIONAL AND LOUNGE



| MODEL | BASES | | TOP SPECIFICATIONS | | | | | | OPTIONS | LBS |
|--------------|----------|------|--------------------|----------|--------------------|----------------------------|--------------------------------|----------------------------|---------|-----|
| | Code | Qty. | For Laminate Top | | | For Veneer Top | | | | |
| | | | SE PVF 2MM | HF HB | HBV HBVR HBG | HF2 HB2 HKN4 HBG2 | HF HB HBV HBVR HBG | HF2 HB2 HKN4 HBG2 | | |
| <i>Round</i> | | | | | | | | | | |
| 18D | DANI18 | 1 | 497 | 869 | 906 | 1015 | 1074 | 1186 | | 20 |
| | DANI018 | 1 | 611 | 983 | 1020 | 1129 | 1188 | 1300 | | 20 |
| | DANIOM18 | 1 | 769 | 1513 | 1587 | 1805 | 1923 | 2147 | | 30 |
| 24D | DANI18 | 1 | 509 | 869 | 906 | 1015 | 1074 | 1186 | | 27 |
| | DANI018 | 1 | 623 | 983 | 1020 | 1129 | 1188 | 1300 | | 27 |
| | DANIOM18 | 1 | 793 | 1513 | 1587 | 1805 | 1923 | 2147 | | 37 |
| 30D | DANI18 | 1 | 613 | 968 | 1015 | 1233 | 1178 | 1342 | | 37 |
| | DANI018 | 1 | 727 | 1082 | 1129 | 1347 | 1292 | 1456 | | 37 |
| | DANIOM18 | 1 | 1001 | 1711 | 1805 | 2241 | 2131 | 2459 | | 47 |
| 36D | DANI18 | 1 | 712 | 1225 | 1316 | 1494 | 1548 | 1777 | | 48 |
| | DANI018 | 1 | 826 | 1339 | 1430 | 1608 | 1662 | 1891 | | 48 |
| | DANIOM18 | 1 | 1199 | 2225 | 2407 | 2763 | 2871 | 3329 | | 58 |
| 42D | DANI18 | 1 | 997 | 1573 | 1697 | 1962 | 1988 | 2301 | | 62 |
| | DANI018 | 1 | 1111 | 1687 | 1811 | 2076 | 2102 | 2415 | | 62 |
| | DANIOM18 | 1 | 1769 | 2921 | 3169 | 3699 | 3751 | 4377 | | 72 |



18D-DANI

STANDARD FEATURES

- Select from 15 standard laminates or choose any standard Wilsonart, Nevamar, Formica, Arborite and Pionite matte finish laminates at no upcharge. For other laminate please contact the factory for pricing.
- 9 standard veneer and hardwood edge stains. Stain-to-match available at no upcharge.
- Bases available in any Spectone color.
- Standard table height 18".
- All bases are standard with floor leveling glides.

OPTIONS

- Custom heights available.
- For applicable Power & Data modules, please see Table Accessories Price List.

HOW TO ORDER

1. Select Model
2. Select Base
3. Select Edge Style
4. Select Top Finish
5. Select Edge Finish
6. Select Base Finish

Example: 18D - DANI - PVF





DANI TABLES

OCCASIONAL AND LOUNGE



| MODEL | BASES | | TOP SPECIFICATIONS | | | | | | OPTIONS | LBS |
|------------------|----------|------|--------------------|--|--------------------|-----------------------------|--------------------------------|-----------------------------|---------|-----|
| | Code | Qty. | For Laminate Top | | | For Veneer Top | | | | |
| | | | SE PVF 2MM | HF HB PKNR ¹ PF ¹ | HBV HBVR HBG | HF2 HB2 HKNR4 HBG2 | HF HB HBV HBVR HBG | HF2 HB2 HKNR4 HBG2 | | |
| <i>Square</i> | | | | | | | | | | |
| 18 x 18SQ | DANI18 | 1 | 529 | 735 | 772 | 840 | 890 | 1057 | | 20 |
| | DANI018 | 1 | 643 | 849 | 886 | 954 | 1004 | 1171 | | 20 |
| | DANIOM18 | 1 | 833 | 1245 | 1319 | 1455 | 1555 | 1889 | | 30 |
| 24 x 24SQ | DANI18 | 1 | 540 | 735 | 772 | 840 | 890 | 1057 | | 27 |
| | DANI018 | 1 | 654 | 849 | 886 | 954 | 1004 | 1171 | | 27 |
| | DANIOM18 | 1 | 855 | 1245 | 1319 | 1455 | 1555 | 1889 | | 37 |
| 30 x 30SQ | DANI18 | 1 | 647 | 789 | 840 | 1020 | 954 | 1186 | | 37 |
| | DANI018 | 1 | 761 | 903 | 954 | 1134 | 1068 | 1300 | | 37 |
| | DANIOM18 | 1 | 1069 | 1353 | 1455 | 1815 | 1683 | 2147 | | 47 |
| 36 x 36SQ | DANI18 | 1 | 730 | 953 | 1015 | 1225 | 1233 | 1433 | | 48 |
| | DANI018 | 1 | 844 | 1067 | 1129 | 1339 | 1347 | 1547 | | 48 |
| | DANIOM18 | 1 | 1235 | 1681 | 1805 | 2225 | 2241 | 2641 | | 58 |
| <i>Rectangle</i> | | | | | | | | | | |
| 24 x 36RE | DANI18 | 1 | 636 | 768 | 817 | 885 | 938 | 1069 | | 36 |
| | DANI018 | 1 | 750 | 882 | 931 | 999 | 1052 | 1183 | | 36 |
| | DANIOM18 | 1 | 1047 | 1311 | 1409 | 1545 | 1651 | 1913 | | 46 |

¹ Exposed Baltic Birch plywood edge (PKNR, PF) can only be specified on tops up to 47-1/2" x 95-1/2". Clear finish only.



STANDARD FEATURES

- Select from 15 standard laminates or choose any standard Wilsonart, Nevamar, Formica, Arborite and Pionite matte finish laminates at no upcharge. For other laminate please contact the factory for pricing.
- 9 standard veneer and hardwood edge stains. Stain-to-match available at no upcharge.
- Bases available in any Spectone color.
- Standard table height 18".
- All bases are standard with floor leveling glides.

OPTIONS

- Custom heights available.
- For applicable Power & Data modules, please see Table Accessories Price List.

HOW TO ORDER

1. Select Model
2. Select Base
3. Select Edge Style
4. Select Top Finish
5. Select Edge Finish
6. Select Base Finish

Example: 18SQ - DANI - PVF
 MODEL | BASE | EDGE



DANI TABLES

OCCASIONAL AND LOUNGE



| MODEL | BASES | | TOP SPECIFICATIONS | | | | | | OPTIONS | LBS |
|------------------|-------------|-------------|-------------------------|-------------------|------|-----------------------|------|-------|---------|-----|
| | <i>Code</i> | <i>Qty.</i> | <i>For Laminate Top</i> | | | <i>For Veneer Top</i> | | | | |
| | | | SE | HF | HBV | HF2 | HF | HF2 | | |
| | | | PVF | HB | HBVR | HB2 | HB | HB2 | | |
| | | | 2MM | PKNR ¹ | HG | HKN4 | HBV | HKN4 | | |
| | | | | PF ¹ | | HKNR4 | HBVR | HKNR4 | | |
| | | | | | | HG2 | HG | HG2 | | |
| <i>Rectangle</i> | | | | | | | | | | |
| 24 x 42RE | DANI18 | 1 | 701 | 916 | 972 | 1073 | 1134 | 1315 | | 40 |
| | DANI018 | 1 | 815 | 1030 | 1086 | 1187 | 1248 | 1429 | | 40 |
| | DANIOM18 | 1 | 1177 | 1607 | 1719 | 1921 | 2043 | 2405 | | 50 |
| 24 x 48RE | DANI18 | 1 | 701 | 916 | 972 | 1073 | 1134 | 1315 | | 44 |
| | DANI018 | 1 | 815 | 1030 | 1086 | 1187 | 1248 | 1429 | | 44 |
| | DANIOM18 | 1 | 1177 | 1607 | 1719 | 1921 | 2043 | 2405 | | 54 |
| 30 x 36RE | DANI18 | 1 | 730 | 885 | 939 | 1028 | 1090 | 1248 | | 42 |
| | DANI018 | 1 | 844 | 999 | 1053 | 1142 | 1204 | 1362 | | 42 |
| | DANIOM18 | 1 | 1235 | 1545 | 1653 | 1831 | 1955 | 2271 | | 52 |
| 30 x 42RE | DANI18 | 1 | 752 | 1046 | 1113 | 1229 | 1315 | 1535 | | 47 |
| | DANI018 | 1 | 866 | 1160 | 1227 | 1343 | 1429 | 1649 | | 47 |
| | DANIOM18 | 1 | 1279 | 1867 | 2001 | 2233 | 2405 | 2845 | | 57 |
| 30 x 48RE | DANI18 | 1 | 752 | 1046 | 1113 | 1229 | 1315 | 1535 | | 52 |
| | DANI018 | 1 | 866 | 1160 | 1227 | 1343 | 1429 | 1649 | | 52 |
| | DANIOM18 | 1 | 1279 | 1867 | 2001 | 2233 | 2405 | 2845 | | 62 |

¹ Exposed Baltic Birch plywood edge (PKNR, PF) can only be specified on tops up to 47-1/2" x 95-1/2". Clear finish only.



STANDARD FEATURES

- Select from 15 standard laminates or choose any standard Wilsonart, Nevamar, Formica, Arborite and Pionite matte finish laminates at no upcharge. For other laminate please contact the factory for pricing.
- 9 standard veneer and hardwood edge stains. Stain-to-match available at no upcharge.
- Bases available in any Spectone color.
- Standard table height 18".
- All bases are standard with floor leveling glides.

OPTIONS

- Custom heights available.
- For applicable Power & Data modules, please see Table Accessories Price List.

HOW TO ORDER

1. Select Model
2. Select Base
3. Select Edge Style
4. Select Top Finish
5. Select Edge Finish
6. Select Base Finish

Example: 2442RE - DANI - PVF
 MODEL | BASE | EDGE

DOCKER TABLES



PRODUCT CODE

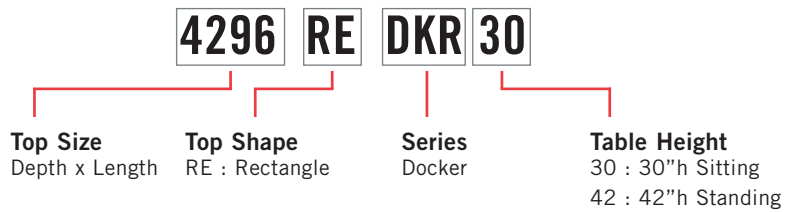

FINISHES

LAMINATE



Select from 15 standard laminates or choose any standard Wilsonart, Nevamar, Formica, Arborite and Pionite matte finish laminates at no upcharge

VENEER



Select from one of our 9 standard wood stains or stain-to-match at no upcharge

BASE



Select from one of our 76 standard Spectone colors

EDGE



See Spectone Card or specfurniture.com/materials/finishes for a complete list of finish options and colors.

DOCKER TABLES

HOW TO ORDER

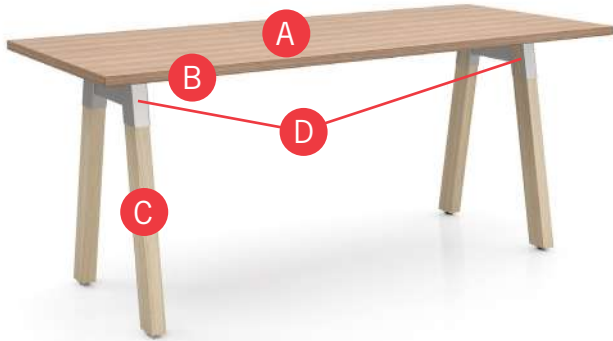

Specify Top Size (Width x Length)

- A** Specify Top Type and Finish
For Laminate Top: Manufacturer, Laminate Name & Code
For Veneer Top: Wood Stain
 - B** Specify Edge Type, (for hardwood: Style), and Finish
PVC/2mm/Self Edge/Exposed Baltic Birch Plywood/Hardwood
 - C** Specify Base Style and Wood Finish
 - D** Specify Base Metal Finish
- Optional: Casters, Power and Data Modules

| Top Size | Top Type and Finish | Edge Type and Finish | Base Style, Wood Finish | Base Metal Finish |
|----------|---------------------------------|--|-------------------------|-------------------|
| 36 x 72 | Laminate, Arborite, Brown Sugar | Self Edge, Laminate, Arborite, Brown Sugar | DKR30, Natural Wood | Silver |



EDGE PROFILES

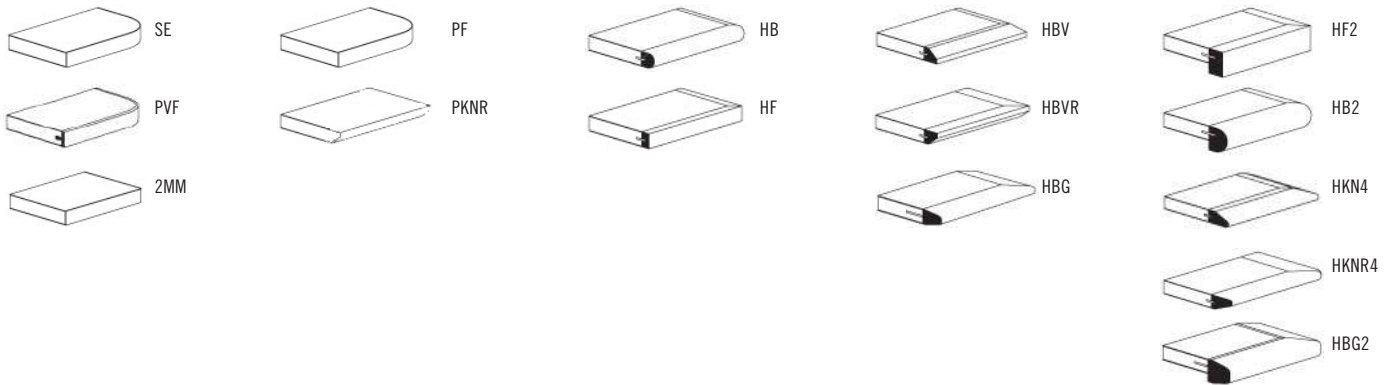

DOCKER TABLES

COLLABORATIVE - 30" HIGH

| MODEL | BASES <i>Code</i> | TOP SPECIFICATIONS | | | | | | OPTIONS | | LBS |
|-----------------|----------------------|-------------------------|--|--------------------|-------------------------------------|--------------------------------|-------------------------------------|------------------------|-------------------------------------|-----|
| | | <i>For Laminate Top</i> | | | <i>For Veneer Top</i> | | | <i>Footrail (each)</i> | <i>Casters (includes Stretcher)</i> | |
| | | SE PVF 2MM | HF HB PKNR ¹ PF ¹ | HBV HBVR HBG | HF2 HB2 HKN4 HKNR4 HBG2 | HF HB HBV HBVR HBG | HF2 HB2 HKN4 HKNR4 HBG2 | | | |
| <i>30" high</i> | | | | | | | | | | |
| 24 X 72RE | DKR30 | 2992 | 3369 | 3455 | 3597 | 3688 | 3960 | 440 | 830 | 88 |
| 24 X 84RE | DKR30 | 3113 | 3532 | 3636 | 3784 | 3898 | 4200 | 440 | 830 | 95 |
| 24 X 96RE | DKR30 | 3136 | 3663 | 3784 | 3967 | 4097 | 4449 | 440 | 830 | 103 |
| 30 X 72RE | DKR30 | 3129 | 3552 | 3659 | 3875 | 3988 | 4324 | 440 | 830 | 99 |
| 30 X 84RE | DKR30 | 3357 | 3732 | 3859 | 4110 | 4242 | 4628 | 440 | 830 | 108 |
| 30 X 96RE | DKR30 | 3379 | 3957 | 4110 | 4342 | 4498 | 4938 | 440 | 830 | 117 |
| 36 X 72RE | DKR30 | 3189 | 3659 | 3780 | 4059 | 4195 | 4596 | 440 | 830 | 113 |
| 36 X 84RE | DKR30 | 3530 | 4033 | 4191 | 4434 | 4592 | 5065 | 440 | 830 | 124 |
| 36 X 96RE | DKR30 | 3537 | 4254 | 4434 | 4717 | 4899 | 5423 | 440 | 830 | 134 |
| 42 X 72RE | DKR30 | 3485 | 3938 | 4096 | 4338 | 4494 | 4967 | 440 | 830 | 124 |
| 42 X 84RE | DKR30 | 3778 | 4210 | 4383 | 4801 | 4938 | 5486 | 440 | 830 | 136 |
| 42 X 96RE | DKR30 | 3831 | 4741 | 4987 | 5236 | 5604 | 6316 | 440 | 830 | 149 |

¹ Exposed Baltic Birch plywood edge (PKNR, PF) can only be specified on tops up to 47-1/2" x 95-1/2". Clear finish only.



DKR30



DKR30

WITH OPTIONAL CASTERS



OPTIONAL INTEGRATED VERTICAL WIRE MANAGER

STANDARD FEATURES

- Select from 15 standard laminates or choose any standard Wilsonart, Nevamar, Formica, Arborite and Pionite matte finish laminates at no upcharge. For other laminate please contact the factory for pricing.
- Standard in Solid Maple wood legs.
- Wood base components available in natural wood and 9 standard wood stains. Stain-to-match available at no upcharge.
- Metal base components available in any Spectone color.
- Standard with leveling glides.
- Ships Knocked Down.

OPTIONS

- 4 locking casters standard in Grey, stretcher included
- For applicable Power & Data modules, please see Table Accessories Price List.
- Footrail can be placed centered, on the left, right, or both sides of the table. On 24" w tables one footrest is recommended, centered.
- Integrated vertical wire manager is available on inside right leg only, add \$260 List each.
- For 1-3/4" solid wood top, please contact Factory.
- Chroming is available, please contact Factory.

HOW TO ORDER

1. Select Model
2. Select Base
3. Select Edge Style
4. Select Options
5. Select Top Finish
6. Select Edge Finish
7. Select Base Finish

Example: 3684RE - DKR30 - 2MM

MODEL | BASE | EDGE



DOCKER TABLES COLLABORATIVE - 36" HIGH

| MODEL | BASES <i>Code</i> | TOP SPECIFICATIONS | | | | | | OPTIONS | | LBS |
|-----------------|----------------------|-------------------------|--|--------------------|-------------------------------------|--------------------------------|-------------------------------------|------------------------|-------------------------------------|-----|
| | | <i>For Laminate Top</i> | | | <i>For Veneer Top</i> | | | <i>Footrail (each)</i> | <i>Casters (includes Stretcher)</i> | |
| | | SE PVF 2MM | HF HB PKNR ¹ PF ¹ | HBV HBVR HBG | HF2 HB2 HKN4 HKNR4 HBG2 | HF HB HBV HBVR HBG | HF2 HB2 HKN4 HKNR4 HBG2 | | | |
| <i>36" high</i> | | | | | | | | | | |
| 24 X 72RE | DKR36 | 3616 | 3993 | 4079 | 4221 | 4312 | 4584 | 440 | 830 | 102 |
| 24 X 84RE | DKR36 | 3737 | 4156 | 4260 | 4408 | 4522 | 4824 | 440 | 830 | 109 |
| 24 X 96RE | DKR36 | 3760 | 4287 | 4408 | 4591 | 4721 | 5073 | 440 | 830 | 117 |
| 30 X 72RE | DKR36 | 3753 | 4176 | 4283 | 4499 | 4612 | 4948 | 440 | 830 | 113 |
| 30 X 84RE | DKR36 | 3981 | 4356 | 4483 | 4734 | 4866 | 5252 | 440 | 830 | 122 |
| 30 X 96RE | DKR36 | 4003 | 4581 | 4734 | 4966 | 5122 | 5562 | 440 | 830 | 131 |
| 36 X 72RE | DKR36 | 3813 | 4283 | 4404 | 4683 | 4819 | 5220 | 440 | 830 | 128 |
| 36 X 84RE | DKR36 | 4154 | 4657 | 4815 | 5058 | 5216 | 5689 | 440 | 830 | 139 |
| 36 X 96RE | DKR36 | 4161 | 4878 | 5058 | 5341 | 5523 | 6047 | 440 | 830 | 149 |
| 42 X 72RE | DKR36 | 4109 | 4562 | 4720 | 4962 | 5118 | 5591 | 440 | 830 | 139 |
| 42 X 84RE | DKR36 | 4402 | 4834 | 5007 | 5425 | 5562 | 6110 | 440 | 830 | 151 |
| 42 X 96RE | DKR36 | 4455 | 5365 | 5611 | 5860 | 6228 | 6940 | 440 | 830 | 164 |

¹ Exposed Baltic Birch plywood edge (PKNR, PF) can only be specified on tops up to 47-1/2" x 95-1/2". Clear finish only.



DKR36



OPTIONAL INTEGRATED VERTICAL WIRE MANAGER

STANDARD FEATURES

- Standard with a lower crossmember on each leg
- Select from 15 standard laminates or choose any standard Wilsonart, Nevamar, Formica, Arborite and Pionite matte finish laminates at no upcharge. For other laminate please contact the factory for pricing.
- Standard in Solid Maple wood legs.
- Wood base components available in natural wood and 9 standard wood stains. Stain-to-match available at no upcharge.
- Standard with leveling glides.
- Metal base components available in any Spectone color.
- Ships Knocked Down.

OPTIONS

- 4 locking casters standard in Grey, stretcher included
- For applicable Power & Data modules, please see Table Accessories Price List.
- Footrail can be placed centered, on the left, right, or both sides of the table. On 24" w tables one footrest is recommended, centered.
- Integrated vertical wire manager is available on inside right leg only, add \$260 List each.
- For 1-3/4" solid wood top, please contact Factory.
- Chroming is available, please contact Factory.

HOW TO ORDER

1. Select Model
2. Select Base
3. Select Edge Style
4. Select Options
5. Select Top Finish
6. Select Edge Finish
7. Select Base Finish

Example: 3684RE - DKR36 - 2MM

MODEL | BASE | EDGE



DOCKER TABLES

COLLABORATIVE - 42" HIGH

| MODEL | BASES | TOP SPECIFICATIONS | | | | | | OPTIONS | | LBS |
|-----------------|-------|--------------------|--|--------------------|-------------------------------------|--------------------------------|-------------------------------------|-----------------|------------------------------|-----|
| | | For Laminate Top | | | For Veneer Top | | | Footrail (each) | Casters (includes Stretcher) | |
| | Code | SE PVF 2MM | HF HB PKNR ¹ PF ¹ | HBV HBVR HBG | HF2 HB2 HKN4 HKNR4 HBG2 | HF HB HBV HBVR HBG | HF2 HB2 HKN4 HKNR4 HBG2 | | | |
| <i>42" high</i> | | | | | | | | | | |
| 24 X 72RE | DKR42 | 3616 | 3993 | 4079 | 4221 | 4312 | 4584 | 440 | 830 | 102 |
| 24 X 84RE | DKR42 | 3737 | 4156 | 4260 | 4408 | 4522 | 4824 | 440 | 830 | 109 |
| 24 X 96RE | DKR42 | 3760 | 4287 | 4408 | 4591 | 4721 | 5073 | 440 | 830 | 117 |
| 30 X 72RE | DKR42 | 3753 | 4176 | 4283 | 4499 | 4612 | 4948 | 440 | 830 | 113 |
| 30 X 84RE | DKR42 | 3981 | 4356 | 4483 | 4734 | 4866 | 5252 | 440 | 830 | 122 |
| 30 X 96RE | DKR42 | 4003 | 4581 | 4734 | 4966 | 5122 | 5562 | 440 | 830 | 131 |
| 36 X 72RE | DKR42 | 3813 | 4283 | 4404 | 4683 | 4819 | 5220 | 440 | 830 | 128 |
| 36 X 84RE | DKR42 | 4154 | 4657 | 4815 | 5058 | 5216 | 5689 | 440 | 830 | 139 |
| 36 X 96RE | DKR42 | 4161 | 4878 | 5058 | 5341 | 5523 | 6047 | 440 | 830 | 149 |
| 42 X 72RE | DKR42 | 4109 | 4562 | 4720 | 4962 | 5118 | 5591 | 440 | 830 | 139 |
| 42 X 84RE | DKR42 | 4402 | 4834 | 5007 | 5425 | 5562 | 6110 | 440 | 830 | 151 |
| 42 X 96RE | DKR42 | 4455 | 5365 | 5611 | 5860 | 6228 | 6940 | 440 | 830 | 164 |

¹ Exposed Baltic Birch plywood edge (PKNR, PF) can only be specified on tops up to 47-1/2" x 95-1/2". Clear finish only.



DKR42



DKR42

WITH OPTIONAL CASTERS



OPTIONAL INTEGRATED VERTICAL WIRE MANAGER

STANDARD FEATURES

- Standard with a lower crossmember on each leg
- Select from 15 standard laminates or choose any standard Wilsonart, Nevamar, Formica, Arborite and Pionite matte finish laminates at no upcharge. For other laminate please contact the factory for pricing.
- Standard in Solid Maple wood legs.
- Wood base components available in natural wood and 9 standard wood stains. Stain-to-match available at no upcharge.
- Standard with leveling glides.
- Metal base components available in any Spectone color.
- Ships Knocked Down.

OPTIONS

- 4 locking casters standard in Grey, stretcher included
- For applicable Power & Data modules, please see Table Accessories Price List.
- Footrail can be placed centered, on the left, right, or both sides of the table. On 24" w tables one footrest is recommended, centered.
- Integrated vertical wire manager is available on inside right leg only, add \$260 List each.
- For 1-3/4" solid wood top, please contact Factory.
- Chroming is available, please contact Factory.

HOW TO ORDER

1. Select Model
2. Select Base
3. Select Edge Style
4. Select Options
5. Select Top Finish
6. Select Edge Finish
7. Select Base Finish

Example: 3684RE - DKR42 - 2MM

MODEL | BASE | EDGE

DRUM, CUBE & OVAL TABLES



PRODUCT CODE

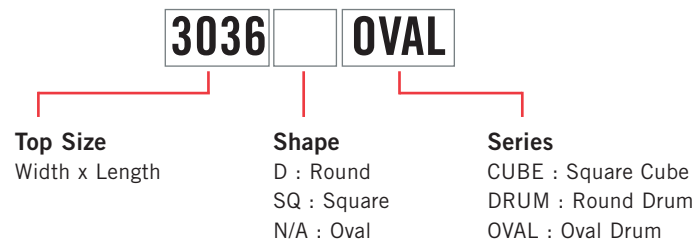

FINISHES

LAMINATE



Select from 15 standard laminates or choose any standard Wilsonart, Nevamar, Formica, Arborite and Pionite matte finish laminates at no upcharge

VENEER



Select from one of our 9 standard wood stains or stain-to-match at no upcharge

EDGE

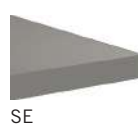

See Spectone Card or specfurniture.com/materials/finishes for a complete list of finish options and colors.

HOW TO ORDER

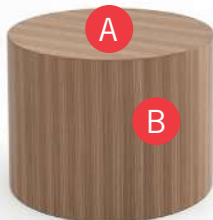

Specify Size and Shape

- A** Specify Top Finish
For Laminate Top: *Manufacturer, Laminate Name, Laminate Code*
For Veneer Top: *Wood Stain*
- B** Specify Side Finish
For Laminate Side: *Manufacturer, Laminate Name, Laminate Code*
For Veneer Side: *Wood Stain*

Optional: 2" Kickplate, Power and Data Modules, Custom Solutions

| Top Size and Shape | Top Type and Finish | Edge Type and Finish |
|--------------------|---------------------------------|---------------------------------|
| 30D, Round | Laminate, Arborite, Brown Sugar | Laminate, Arborite, Brown Sugar |



DRUM, CUBE & OVAL TABLES

OCCASIONAL AND LOUNGE



| MODEL | BASES | | TOP SPECIFICATIONS | | OPTIONS | LBS |
|---------------|-------|------|--------------------|--------------|-----------------|-----|
| | Code | Qty. | Laminate SE | Veneer SE | Kickplate KP | |
| <i>Round</i> | | | | | | |
| 18D | DRM | 1 | 787 | 829 | 51 | 19 |
| 24D | DRM | 1 | 832 | 878 | 51 | 29 |
| 30D | DRM | 1 | 1045 | 1093 | 51 | 40 |
| 36D | DRM | 1 | 1185 | 1234 | 51 | 51 |
| 42D | DRM | 1 | 1314 | 1400 | 51 | 63 |
| <i>Square</i> | | | | | | |
| 18 x 18SQ | CUBE | 1 | 598 | 829 | 51 | 35 |
| 24 x 24SQ | CUBE | 1 | 631 | 877 | 51 | 56 |
| 30 x 30SQ | CUBE | 1 | 792 | 967 | 51 | 69 |
| 36 x 36SQ | CUBE | 1 | 921 | 1507 | 51 | 90 |
| <i>Oval</i> | | | | | | |
| 30 x 36 | OVAL | 1 | 1743 | 1815 | 75 | 52 |
| 30 x 42 | OVAL | 1 | 1930 | 2059 | 75 | 60 |
| 30 x 48 | OVAL | 1 | 2449 | 2579 | 75 | 72 |



STANDARD FEATURES

- Select from 15 standard laminates or choose any standard Wilsonart, Nevamar, Formica, Arborite and Pionite matte finish laminates at no upcharge. For other laminate please contact the factory for pricing.
- 9 standard veneer and hardwood edge stains. Stain-to-match available at no upcharge.
- Other sizes are available. Contact the factory for pricing.
- Standard heights: 16", 18", 20" and 22". Please specify when ordering
- All bases are standard with floor leveling glides.

OPTIONS

- Custom heights available.
- 2" kickplate, standard in Brushed Natural Aluminum, HOMAPAL® 441.
- For a mousehole cutout, please contact factory.
- For solid surface tops, please contact factory.
- For applicable Power & Data modules, please see Table Accessories Price List.

HOW TO ORDER

1. Select Model
2. Select Base
3. Select Edge Style
4. Select Top Finish
5. Select Edge Finish
6. Select Base Finish

Example: 18D - DRM - SE

MODEL
BASE
EDGE

DRUM BASE TABLES



PRODUCT CODE

4896 RE DR - L

Top Size

Width x Length

Top Shape

- D : Round
- SQ : Square
- RE : Rectangle
- RT : Racetrack
- BT : Boatshape
- BTA : Boatshape Arc

Series

- DR : Drum
- HDR : Half Drum
- DDR : D-Drum

Finish

- L : Laminate
- V : Veneer



FINISHES

LAMINATE



Select from 15 standard laminates or choose any standard Wilsonart, Nevamar, Formica, Arborite and Pionite matte finish laminates at no upcharge

VENEER



Select from one of our 9 standard wood stains or stain-to-match at no upcharge

EDGE



See Spectone Card or specfurniture.com/materials/finishes for a complete list of finish options and colors.

DRUM BASE TABLES

HOW TO ORDER

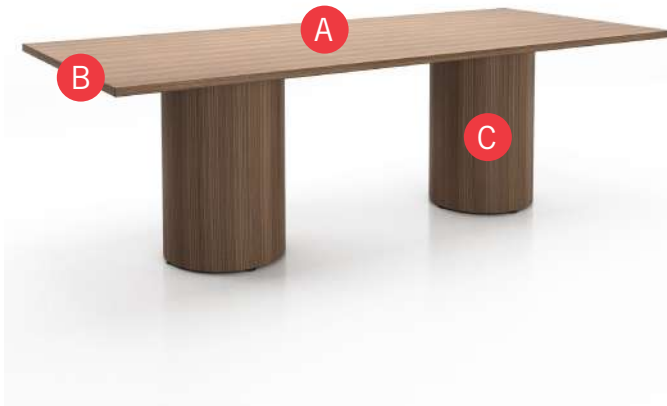

Specify Top Size (Width x Length) and Shape

- A** Specify Top Type and Finish
For Laminate Top: Manufacturer, Laminate Name, Laminate Code
For Veneer Top: Wood Stain
- B** Specify Edge Type, (for hardwood: Style), and Finish
PVC/2mm/Self Edge/Exposed Baltic Birch Plywood/Hardwood
- C** Specify Base Style and Finish
For Laminate Top: Manufacturer, Laminate Name, Laminate Code
For Veneer Top: Wood Stain

Optional: Power and Data Modules, Custom Solutions

| Top Size and Shape | Top Type and Finish | Edge Type and Finish | Base Style and Finish |
|--------------------|---------------------------|---------------------------------|--------------------------------|
| 36 x 72, Racetrack | Veneer, Wild Cherry Stain | Hardwood, HB, Wild Cherry Stain | HDR, Veneer, Wild Cherry Stain |



EDGE PROFILES

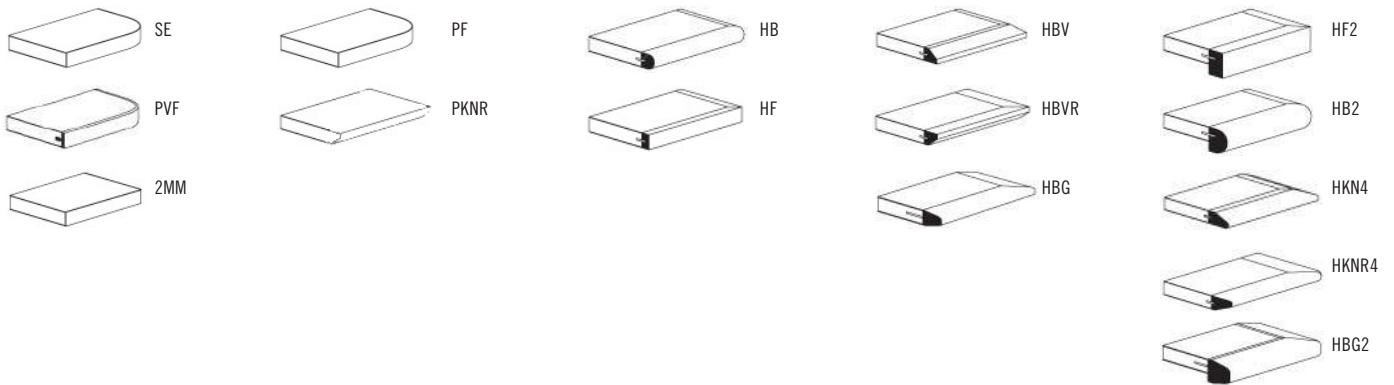



DRUM BASES TABLES BOARDROOM AND CONFERENCE



| MODEL | BASES | | TOP SPECIFICATIONS | | | | | | OPTIONS | LBS |
|---------------|-------|------|--------------------|-------------------|------|----------------|------|-------|---------|-----|
| | Code | Qty. | For Laminate Top | | | For Veneer Top | | | | |
| | | | SE | HF | HBV | HF2 | HF | HF2 | | |
| | | | PVF | HB | HBVR | HB2 | HB | HB2 | | |
| | | | 2MM | PKNR ¹ | HBG | HKN4 | HBV | HKN4 | | |
| | | | | PF ¹ | | HKNR4 | HBVR | HKNR4 | | |
| | | | | | | HBG2 | HBG | HBG2 | | |
| <i>Round</i> | | | | | | | | | | |
| 42D | DR-L | 1 | 1713 | 2289 | 2413 | 2678 | 2704 | 3017 | | 102 |
| | DR-V | 1 | 1891 | 2467 | 2591 | 2856 | 2882 | 3195 | | 102 |
| 48D | DR-L | 1 | 1736 | 2509 | 2644 | 2776 | 3250 | 3652 | | 118 |
| | DR-V | 1 | 1914 | 2687 | 2822 | 2954 | 3428 | 3830 | | 118 |
| 54D | DR-L | 1 | 2026 | 3166 | 3376 | 3576 | 3812 | 4328 | | 136 |
| | DR-V | 1 | 2204 | 3344 | 3554 | 3754 | 3990 | 4506 | | 136 |
| 60D | DR-L | 1 | 2074 | 3368 | 3592 | 3761 | 4447 | 5088 | | 155 |
| | DR-V | 1 | 2252 | 3546 | 3770 | 3939 | 4625 | 5266 | | 155 |
| <i>Square</i> | | | | | | | | | | |
| 36 x 36SQ | DR-L | 1 | 1446 | 1669 | 1731 | 1941 | 1949 | 2149 | | 88 |
| | DR-V | 1 | 1624 | 1847 | 1909 | 2119 | 2127 | 2327 | | 88 |
| 42 x 42SQ | DR-L | 1 | 1727 | 2050 | 2149 | 2249 | 2318 | 2591 | | 102 |
| | DR-V | 1 | 1905 | 2228 | 2327 | 2427 | 2496 | 2769 | | 102 |
| 48 x 48SQ | DR-L | 1 | 1881 | 2164 | 2269 | 2316 | 2694 | 3047 | | 118 |
| | DR-V | 1 | 2059 | 2342 | 2447 | 2494 | 2872 | 3225 | | 118 |
| 54 x 54SQ | DR-L | 1 | 2029 | 2653 | 2817 | 3007 | 3111 | 3568 | | 136 |
| | DR-V | 1 | 2207 | 2831 | 2995 | 3185 | 3289 | 3746 | | 136 |
| 60 x 60SQ | DR-L | 1 | 2059 | 2759 | 2934 | 3125 | 3590 | 4143 | | 155 |
| | DR-V | 1 | 2237 | 2937 | 3112 | 3303 | 3768 | 4321 | | 155 |



¹ Exposed Baltic Birch plywood edge (PKNR, PF) can only be specified on square tops up to 47-1/2" x 95-1/2". Clear finish only.



4296RT-DR-L

STANDARD FEATURES

- Select from 15 standard laminates or choose any standard Wilsonart, Nevamar, Formica, Arborite and Pionite matte finish laminates at no upcharge. For other laminate please contact the factory for pricing.
- 9 standard veneer and hardwood edge stains. Stain-to-match available at no upcharge.
- Standard table height 29".
- All bases are standard with floor leveling glides.

OPTIONS

- Custom heights available.
- For applicable Power & Data modules, please see Table Accessories Price List.

HOW TO ORDER

1. Select Model
2. Select Base
3. Select Edge Style
4. Select Options
5. Select Top Finish
6. Select Edge Finish
7. Select Base Finish

Example: 42D - DR-L - PVF -



DRUM BASES TABLES BOARDROOM AND CONFERENCE

| MODEL | BASES | | TOP SPECIFICATIONS | | | | | | OPTIONS | LBS |
|------------------|-------|------|--------------------|--|--------------------|-----------------------------|--------------------------------|-----------------------------|---------|-----|
| | Code | Qty. | For Laminate Top | | | For Veneer Top | | | | |
| | | | SE PVF 2MM | HF HB PKNR ¹ PF ¹ | HBV HBVR HBG | HF2 HB2 HKNR4 HBG2 | HF HB HBV HBVR HBG | HF2 HB2 HKNR4 HBG2 | | |
| <i>Rectangle</i> | | | | | | | | | | |
| 36 x 66RE | HDR-L | 2 | 2830 | 3280 | 3407 | 3600 | 3722 | 4093 | | 176 |
| | HDR-V | 2 | 3186 | 3636 | 3763 | 3956 | 4078 | 4449 | | 176 |
| 36 x 72RE | HDR-L | 2 | 2869 | 3339 | 3460 | 3739 | 3875 | 4276 | | 176 |
| | HDR-V | 2 | 3225 | 3695 | 3816 | 4095 | 4231 | 4632 | | 176 |
| 36 x 78RE | HDR-L | 2 | 3210 | 3713 | 3871 | 4114 | 4272 | 4745 | | 189 |
| | HDR-V | 2 | 3566 | 4069 | 4227 | 4470 | 4628 | 5101 | | 189 |
| 36 x 84RE | HDR-L | 2 | 3210 | 3713 | 3871 | 4114 | 4272 | 4745 | | 189 |
| | HDR-V | 2 | 3566 | 4069 | 4227 | 4470 | 4628 | 5101 | | 189 |
| 36 x 90RE | HDR-L | 2 | 3217 | 3934 | 4114 | 4397 | 4579 | 5103 | | 201 |
| | HDR-V | 2 | 3573 | 4290 | 4470 | 4753 | 4935 | 5459 | | 201 |
| 36 x 96RE | HDR-L | 2 | 3217 | 3934 | 4114 | 4397 | 4579 | 5103 | | 201 |
| | HDR-V | 2 | 3573 | 4290 | 4470 | 4753 | 4935 | 5459 | | 201 |
| 42 x 78RE | HDR-L | 2 | 3458 | 3890 | 4063 | 4481 | 4618 | 5166 | | 203 |
| | HDR-V | 2 | 3814 | 4246 | 4419 | 4837 | 4974 | 5522 | | 203 |
| 42 x 84RE | HDR-L | 2 | 3458 | 3890 | 4063 | 4481 | 4618 | 5166 | | 203 |
| | HDR-V | 2 | 3814 | 4246 | 4419 | 4837 | 4974 | 5522 | | 203 |
| 42 x 96RE | HDR-L | 2 | 3511 | 4421 | 4667 | 4916 | 5284 | 5996 | | 235 |
| | HDR-V | 2 | 3867 | 4777 | 5023 | 5272 | 5640 | 6352 | | 235 |

¹ Exposed Baltic Birch plywood edge (PKNR, PF) can only be specified on tops up to 47-1/2" x 95-1/2". Clear finish only.



4296RT-HDR-L

STANDARD FEATURES

- Select from 15 standard laminates or choose any standard Wilsonart, Nevamar, Formica, Arborite and Pionite matte finish laminates at no upcharge. For other laminate please contact the factory for pricing.
- 9 standard veneer and hardwood edge stains. Stain-to-match available at no upcharge.
- Standard table height 29".
- All bases are standard with floor leveling glides.

OPTIONS

- Custom heights available.
- For applicable Power & Data modules, please see Table Accessories Price List.

HOW TO ORDER

1. Select Model
2. Select Base
3. Select Edge Style
4. Select Options
5. Select Top Finish
6. Select Edge Finish
7. Select Base Finish

Example: 3666RE - HDR-L - PVF -





DRUM BASES TABLES BOARDROOM AND CONFERENCE

| MODEL | BASES | | TOP SPECIFICATIONS | | | | | | OPTIONS | LBS |
|------------------|-------|------|--------------------|--|--------------------|-------------------------------------|--------------------------------|-------------------------------------|---------|-----|
| | Code | Qty. | For Laminate Top | | | For Veneer Top | | | | |
| | | | SE PVF 2MM | HF HB PKNR ¹ PF ¹ | HBV HBVR HBG | HF2 HB2 HKN4 HKNR4 HBG2 | HF HB HBV HBVR HBG | HF2 HB2 HKN4 HKNR4 HBG2 | | |
| <i>Rectangle</i> | | | | | | | | | | |
| 48 x 96RE | HDR-L | 2 | 3511 | 4421 | 4667 | 4916 | 5284 | 5996 | | 235 |
| | HDR-V | 2 | 3867 | 4777 | 5023 | 5272 | 5640 | 6352 | | 235 |
| 48 x 120RE | DR-L | 2 | 3849 | 5024 | 5302 | 5903 | 5991 | 6824 | | 268 |
| | DR-V | 2 | 4205 | 5380 | 5658 | 6259 | 6347 | 7180 | | 268 |
| | DDR-L | 2 | 4127 | 5302 | 5580 | 6181 | 6269 | 7102 | | 284 |
| 48 X 144RE | DDR-V | 2 | 4481 | 5656 | 5934 | 6535 | 6623 | 7456 | | 284 |
| | DR-L | 3 | 5291 | 6976 | 7343 | 7914 | 7778 | 8780 | | 302 |
| | DR-V | 3 | 5825 | 7510 | 7877 | 8448 | 8312 | 9314 | | 302 |
| | DDR-L | 3 | 5708 | 7393 | 7760 | 8331 | 8195 | 9197 | | 318 |
| 48 X 168RE | DDR-V | 3 | 6239 | 7924 | 8291 | 8862 | 8726 | 9728 | | 318 |
| | DR-L | 3 | 5795 | 7491 | 7910 | 8707 | 8523 | 9687 | | 386 |
| | DR-V | 3 | 6329 | 8025 | 8444 | 9241 | 9057 | 10221 | | 386 |
| | DDR-L | 3 | 6077 | 7773 | 8192 | 8989 | 8805 | 9969 | | 410 |
| | DDR-V | 3 | 6608 | 8304 | 8723 | 9520 | 9336 | 10500 | | 410 |

¹ Exposed Baltic Birch plywood edge (PKNR, PF) can only be specified on tops up to 47-1/2" x 95-1/2". Clear finish only.



4296RT-HDR-L



4296RT-DR-L

STANDARD FEATURES

- Select from 15 standard laminates or choose any standard Wilsonart, Nevamar, Formica, Arborite and Pionite matte finish laminates at no upcharge. For other laminate please contact the factory for pricing.
- 9 standard veneer and hardwood edge stains. Stain-to-match available at no upcharge.
- Standard table height 29".
- All bases are standard with floor leveling glides.

OPTIONS

- Custom heights available.
- For applicable Power & Data modules, please see Table Accessories Price List.

HOW TO ORDER

1. Select Model
2. Select Base
3. Select Edge Style
4. Select Options
5. Select Top Finish
6. Select Edge Finish
7. Select Base Finish

Example: 4896RE - HDR-L - PVF -





DRUM BASES TABLES BOARDROOM AND CONFERENCE



| MODEL | BASES | | TOP SPECIFICATIONS | | | | | | OPTIONS | LBS |
|------------------|-------|------|--------------------|----------|--------------------|-----------------------------|------------------------|-----------------------------|---------|-----|
| | Code | Qty. | For Laminate Top | | | For Veneer Top | | | | |
| | | | SE PVF 2MM | HF HB | HBV HBVR HBG | HF2 HB2 HKNR4 HBG2 | HF HB HBV HBG | HF2 HB2 HKNR4 HBG2 | | |
| <i>Rectangle</i> | | | | | | | | | | |
| 60 x 120RE | DR-L | 2 | 4333 | 6090 | 6474 | 7066 | 6925 | 7970 | | 310 |
| | DR-V | 2 | 4689 | 6446 | 6830 | 7422 | 7281 | 8326 | | 310 |
| | DDR-L | 2 | 4611 | 6368 | 6752 | 7344 | 7203 | 8248 | | 326 |
| | DDR-V | 2 | 4965 | 6722 | 7106 | 7698 | 7557 | 8602 | | 326 |
| 60 X 144RE | DR-L | 3 | 5827 | 7936 | 8395 | 9106 | 8938 | 10191 | | 352 |
| | DR-V | 3 | 6361 | 8470 | 8929 | 9640 | 9472 | 10725 | | 352 |
| | DDR-L | 3 | 6244 | 8353 | 8812 | 9523 | 9355 | 10608 | | 368 |
| | DDR-V | 3 | 6775 | 8884 | 9343 | 10054 | 9886 | 11139 | | 368 |
| 60 X 168RE | DR-L | 3 | 6277 | 8736 | 9270 | 10102 | 9905 | 11365 | | 444 |
| | DR-V | 3 | 6811 | 9270 | 9804 | 10636 | 10439 | 11899 | | 444 |
| | DDR-L | 3 | 6559 | 9018 | 9552 | 10384 | 10187 | 11647 | | 468 |
| | DDR-V | 3 | 7090 | 9549 | 10083 | 10915 | 10718 | 12178 | | 468 |



4296RT-DR-L

STANDARD FEATURES

- Select from 15 standard laminates or choose any standard Wilsonart, Nevamar, Formica, Arborite and Pionite matte finish laminates at no upcharge. For other laminate please contact the factory for pricing.
- 9 standard veneer and hardwood edge stains. Stain-to-match available at no upcharge.
- Standard table height 29".
- All bases are standard with floor leveling glides.

OPTIONS

- Custom heights available.
- For applicable Power & Data modules, please see Table Accessories Price List.

HOW TO ORDER

1. Select Model
2. Select Base
3. Select Edge Style
4. Select Options
5. Select Top Finish
6. Select Edge Finish
7. Select Base Finish

Example: 60120RE - DR-L - PVF -





DRUM BASES TABLES BOARDROOM AND CONFERENCE

| MODEL | BASES | | TOP SPECIFICATIONS | | | | | | OPTIONS | LBS |
|------------------|-------|------|--------------------|----------|--------------------|----------------------------|------------------------|----------------------------|---------|-----|
| | Code | Qty. | For Laminate Top | | | For Veneer Top | | | | |
| | | | SE PVF 2MM | HF HB | HBV HBVR HBG | HF2 HB2 HKN4 HBG2 | HF HB HBV HBG | HF2 HB2 HKN4 HBG2 | | |
| <i>Racetrack</i> | | | | | | | | | | |
| 36 x 54RT | HDR-L | 2 | 2797 | 3368 | 3501 | 3739 | 3837 | 4186 | | 163 |
| | HDR-V | 2 | 3153 | 3724 | 3857 | 4095 | 4193 | 4542 | | 163 |
| 36 x 60RT | HDR-L | 2 | 2797 | 3368 | 3501 | 3739 | 3837 | 4186 | | 163 |
| | HDR-V | 2 | 3153 | 3724 | 3857 | 4095 | 4193 | 4542 | | 163 |
| 36 x 66RT | HDR-L | 2 | 2958 | 3555 | 3699 | 3954 | 4178 | 4614 | | 176 |
| | HDR-V | 2 | 3314 | 3911 | 4055 | 4310 | 4534 | 4970 | | 176 |
| 36 x 72RT | HDR-L | 2 | 2958 | 3555 | 3699 | 3954 | 4178 | 4614 | | 176 |
| | HDR-V | 2 | 3314 | 3911 | 4055 | 4310 | 4534 | 4970 | | 176 |
| 36 x 78RT | HDR-L | 2 | 3228 | 3986 | 4163 | 4548 | 4629 | 5137 | | 189 |
| | HDR-V | 2 | 3584 | 4342 | 4519 | 4904 | 4985 | 5493 | | 189 |
| 36 x 84RT | HDR-L | 2 | 3228 | 3986 | 4163 | 4548 | 4629 | 5137 | | 189 |
| | HDR-V | 2 | 3584 | 4342 | 4519 | 4904 | 4985 | 5493 | | 189 |
| 36 x 90RT | HDR-L | 2 | 3232 | 4243 | 4454 | 4885 | 4986 | 5565 | | 201 |
| | HDR-V | 2 | 3588 | 4599 | 4810 | 5241 | 5342 | 5921 | | 201 |
| 36 x 96RT | HDR-L | 2 | 3232 | 4243 | 4454 | 4885 | 4986 | 5565 | | 201 |
| | HDR-V | 2 | 3588 | 4599 | 4810 | 5241 | 5342 | 5921 | | 201 |
| 42 x 78RT | HDR-L | 2 | 3473 | 4190 | 4407 | 4843 | 4948 | 5532 | | 218 |
| | HDR-V | 2 | 3829 | 4546 | 4763 | 5199 | 5304 | 5888 | | 218 |
| 42 x 84RT | HDR-L | 2 | 3473 | 4190 | 4407 | 4843 | 4948 | 5532 | | 218 |
| | HDR-V | 2 | 3829 | 4546 | 4763 | 5199 | 5304 | 5888 | | 218 |
| 42 x 96RT | HDR-L | 2 | 3531 | 4560 | 4811 | 5414 | 5840 | 6599 | | 235 |
| | HDR-V | 2 | 3887 | 4916 | 5167 | 5770 | 6196 | 6955 | | 235 |



4296RT-HDR-L

STANDARD FEATURES

- Select from 15 standard laminates or choose any standard Wilsonart, Nevamar, Formica, Arborite and Pionite matte finish laminates at no upcharge. For other laminate please contact the factory for pricing.
- 9 standard veneer and hardwood edge stains. Stain-to-match available at no upcharge.
- Standard table height 29".
- All bases are standard with floor leveling glides.

OPTIONS

- Custom heights available.
- For applicable Power & Data modules, please see Table Accessories Price List.

HOW TO ORDER

1. Select Model
2. Select Base
3. Select Edge Style
4. Select Options
5. Select Top Finish
6. Select Edge Finish
7. Select Base Finish

Example: 3654RT - HDR-L - PVF -
 MODEL BASE EDGE OPTIONS



DRUM BASES TABLES BOARDROOM AND CONFERENCE

| MODEL | BASES | | TOP SPECIFICATIONS | | | | | | OPTIONS | LBS |
|------------------|-------|------|--------------------|----------|--------------------|----------------------------|--------------------------------|----------------------------|---------|-----|
| | Code | Qty. | For Laminate Top | | | For Veneer Top | | | | |
| | | | SE PVF 2MM | HF HB | HBV HBVR HBG | HF2 HB2 HKN4 HBG2 | HF HB HBV HBVR HBG | HF2 HB2 HKN4 HBG2 | | |
| <i>Racetrack</i> | | | | | | | | | | |
| 48 x 78RT | HDR-L | 2 | 3476 | 4498 | 4744 | 5130 | 5371 | 6035 | | 218 |
| | HDR-V | 2 | 3832 | 4854 | 5100 | 5486 | 5727 | 6391 | | 218 |
| 48 x 84RT | DR-L | 2 | 3476 | 4498 | 4744 | 5130 | 5371 | 6035 | | 218 |
| | DR-V | 2 | 3832 | 4854 | 5100 | 5486 | 5727 | 6391 | | 218 |
| 48 x 96RT | DDR-L | 2 | 3531 | 4560 | 4811 | 5414 | 5840 | 6599 | | 235 |
| | DDR-V | 2 | 3887 | 4916 | 5167 | 5770 | 6196 | 6955 | | 235 |
| 48 x 120RT | DR-L | 2 | 3876 | 5508 | 5835 | 6666 | 6631 | 7518 | | 268 |
| | DR-V | 2 | 4232 | 5864 | 6191 | 7022 | 6987 | 7874 | | 268 |
| | DDR-L | 2 | 4154 | 5786 | 6113 | 6944 | 6909 | 7796 | | 284 |
| | DDR-V | 2 | 4508 | 6140 | 6467 | 7298 | 7263 | 8150 | | 284 |
| 48 x 144RT | DR-L | 3 | 5321 | 7354 | 7755 | 8785 | 8546 | 9622 | | 302 |
| | DR-V | 3 | 5855 | 7888 | 8289 | 9319 | 9080 | 10156 | | 302 |
| | DDR-L | 3 | 5738 | 7771 | 8172 | 9202 | 8963 | 10039 | | 318 |
| | DDR-V | 3 | 6269 | 8302 | 8703 | 9733 | 9494 | 10570 | | 318 |
| 48 x 168RT | DR-L | 3 | 5827 | 8038 | 8506 | 9650 | 9428 | 10675 | | 386 |
| | DR-V | 3 | 6361 | 8572 | 9040 | 10184 | 9962 | 11209 | | 386 |
| | DDR-L | 3 | 6109 | 8320 | 8788 | 9932 | 9710 | 10957 | | 410 |
| | DDR-V | 3 | 6640 | 8851 | 9319 | 10463 | 10241 | 11488 | | 410 |



4296RT-HDR-L



4296RT-DR-L

STANDARD FEATURES

- Select from 15 standard laminates or choose any standard Wilsonart, Nevamar, Formica, Arborite and Pionite matte finish laminates at no upcharge. For other laminate please contact the factory for pricing.
- 9 standard veneer and hardwood edge stains. Stain-to-match available at no upcharge.
- Standard table height 29".
- All bases are standard with floor leveling glides.

OPTIONS

- Custom heights available.
- For applicable Power & Data modules, please see Table Accessories Price List.

HOW TO ORDER

1. Select Model
2. Select Base
3. Select Edge Style
4. Select Options
5. Select Top Finish
6. Select Edge Finish
7. Select Base Finish

Example: 4878RT - HDR-L - PVF -





DRUM BASES TABLES

BOARDROOM AND CONFERENCE



| MODEL | BASES | | TOP SPECIFICATIONS | | | | | | OPTIONS | LBS |
|------------------|-------|------|--------------------|-------|-------|----------------|-------|-------|---------|-----|
| | Code | Qty. | For Laminate Top | | | For Veneer Top | | | | |
| | | | SE | HF | HBV | HF2 | HF | HF2 | | |
| | | | PVF | HB | HBVR | HB2 | HB | HB2 | | |
| | | | 2MM | | HBG | HKNR4 | HBV | HKN4 | | |
| | | | | | | HKNR4 | HBVR | HKNR4 | | |
| | | | | | | HBG2 | HBG | HBG2 | | |
| <i>Racetrack</i> | | | | | | | | | | |
| 60 x 120RT | DR-L | 2 | 4322 | 6362 | 6768 | 7812 | 7765 | 8878 | | 310 |
| | DR-V | 2 | 4678 | 6718 | 7124 | 8168 | 8121 | 9234 | | 310 |
| | DDR-L | 2 | 4600 | 6640 | 7046 | 8090 | 8043 | 9156 | | 326 |
| | DDR-V | 2 | 4954 | 6994 | 7400 | 8444 | 8397 | 9510 | | 326 |
| 60 x 144RT | DR-L | 3 | 5867 | 8408 | 8911 | 10201 | 9900 | 11244 | | 352 |
| | DR-V | 3 | 6401 | 8942 | 9445 | 10735 | 10434 | 11778 | | 352 |
| | DDR-L | 3 | 6284 | 8825 | 9328 | 10618 | 10317 | 11661 | | 368 |
| | DDR-V | 3 | 6815 | 9356 | 9859 | 11149 | 10848 | 12192 | | 368 |
| 60 x 168RT | DR-L | 3 | 6502 | 9267 | 9851 | 11277 | 11001 | 12559 | | 444 |
| | DR-V | 3 | 7036 | 9801 | 10385 | 11811 | 11535 | 13093 | | 444 |
| | DDR-L | 3 | 6784 | 9549 | 10133 | 11559 | 11283 | 12841 | | 468 |
| | DDR-V | 3 | 7315 | 10080 | 10664 | 12090 | 11814 | 13372 | | 468 |



4296RT-DR-L

STANDARD FEATURES

- Select from 15 standard laminates or choose any standard Wilsonart, Nevamar, Formica, Arborite and Pionite matte finish laminates at no upcharge. For other laminate please contact the factory for pricing.
- 9 standard veneer and hardwood edge stains. Stain-to-match available at no upcharge.
- Standard table height 29".
- All bases are standard with floor leveling glides.

OPTIONS

- Custom heights available.
- For applicable Power & Data modules, please see Table Accessories Price List.

HOW TO ORDER

1. Select Model
2. Select Base
3. Select Edge Style
4. Select Options
5. Select Top Finish
6. Select Edge Finish
7. Select Base Finish

Example: 60120RT - DR-L - PVF -





DRUM BASES TABLES BOARDROOM AND CONFERENCE



| MODEL | BASES | | TOP SPECIFICATIONS | | | | | | OPTIONS | LBS |
|------------------|-------|------|--------------------|----------|--------------------|-----------------------------|--------------------------------|-----------------------------|---------|-----|
| | Code | Qty. | For Laminate Top | | | For Veneer Top | | | | |
| | | | SE PVF 2MM | HF HB | HBV HBVR HBG | HF2 HB2 HKNR4 HBG2 | HF HB HBV HBVR HBG | HF2 HB2 HKNR4 HBG2 | | |
| <i>Boatshape</i> | | | | | | | | | | |
| 42 x 96BT | HDR-L | 2 | 3531 | 5262 | 5584 | 5916 | 6387 | 6801 | | 235 |
| | HDR-V | 2 | 3887 | 5618 | 5940 | 6272 | 6743 | 7157 | | 235 |
| 48 x 96BT | HDR-L | 2 | 3531 | 5262 | 5584 | 5916 | 6387 | 6801 | | 235 |
| | HDR-V | 2 | 3887 | 5618 | 5940 | 6272 | 6743 | 7157 | | 235 |
| 48 x 120BT | DR-L | 2 | 3876 | 6277 | 6676 | 7098 | 7277 | 7756 | | 268 |
| | DR-V | 2 | 4232 | 6633 | 7032 | 7454 | 7633 | 8112 | | 268 |
| | DDR-L | 2 | 4154 | 6555 | 6954 | 7376 | 7555 | 8034 | | 284 |
| | DDR-V | 2 | 4508 | 6909 | 7308 | 7730 | 7909 | 8388 | | 284 |
| 48 x 144BT | DR-L | 3 | 5321 | 8124 | 8600 | 9106 | 9744 | 10179 | | 302 |
| | DR-V | 3 | 5855 | 8658 | 9134 | 9640 | 10278 | 10713 | | 302 |
| | DDR-L | 3 | 5738 | 8541 | 9017 | 9523 | 10161 | 10596 | | 318 |
| | DDR-V | 3 | 6269 | 9072 | 9548 | 10054 | 10692 | 11127 | | 318 |
| 48 x 168BT | DR-L | 3 | 5827 | 8889 | 9444 | 10028 | 10326 | 10998 | | 386 |
| | DR-V | 3 | 6361 | 9423 | 9978 | 10562 | 10860 | 11532 | | 386 |
| | DDR-L | 3 | 6109 | 9171 | 9726 | 10310 | 10608 | 11280 | | 410 |
| | DDR-V | 3 | 6640 | 9702 | 10257 | 10841 | 11139 | 11811 | | 410 |



STANDARD FEATURES

- Select from 15 standard laminates or choose any standard Wilsonart, Nevamar, Formica, Arborite and Pionite matte finish laminates at no upcharge. For other laminate please contact the factory for pricing.
- 9 standard veneer and hardwood edge stains. Stain-to-match available at no upcharge.
- Standard table height 29".
- All bases are standard with floor leveling glides.

OPTIONS

- Custom heights available.
- For applicable Power & Data modules, please see Table Accessories Price List.

HOW TO ORDER

1. Select Model
2. Select Base
3. Select Edge Style
4. Select Top Finish
5. Select Edge Finish
6. Select Base Finish

Example: 4296BT - HDR-L - PVF





DRUM BASES TABLES BOARDROOM AND CONFERENCE



| MODEL | BASES | | TOP SPECIFICATIONS | | | | | | OPTIONS | LBS |
|------------------|-------|------|--------------------|----------|--------------------|-----------------------------|--------------------------------|-----------------------------|---------|-----|
| | Code | Qty. | For Laminate Top | | | For Veneer Top | | | | |
| | | | SE PVF 2MM | HF HB | HBV HBVR HBG | HF2 HB2 HKNR4 HBG2 | HF HB HBV HBVR HBG | HF2 HB2 HKNR4 HBG2 | | |
| <i>Boatshape</i> | | | | | | | | | | |
| 60 x 120BT | DR-L | 2 | 4322 | 7321 | 7824 | 8350 | 8576 | 9170 | | 310 |
| | DR-V | 2 | 4678 | 7677 | 8180 | 8706 | 8932 | 9526 | | 310 |
| | DDR-L | 2 | 4600 | 7599 | 8102 | 8628 | 8854 | 9448 | | 326 |
| | DDR-V | 2 | 4954 | 7953 | 8456 | 8982 | 9208 | 9802 | | 326 |
| 60 x 144BT | DR-L | 3 | 5867 | 9372 | 9967 | 10600 | 11395 | 11941 | | 352 |
| | DR-V | 3 | 6401 | 9906 | 10501 | 11134 | 11929 | 12475 | | 352 |
| | DDR-L | 3 | 6284 | 9789 | 10384 | 11017 | 11812 | 12358 | | 368 |
| | DDR-V | 3 | 6815 | 10320 | 10915 | 11548 | 12343 | 12889 | | 368 |
| 60 x 168BT | DR-L | 3 | 6502 | 10330 | 11021 | 11752 | 12122 | 12964 | | 444 |
| | DR-V | 3 | 7036 | 10864 | 11555 | 12286 | 12656 | 13498 | | 444 |
| | DDR-L | 3 | 6784 | 10612 | 11303 | 12034 | 12404 | 13246 | | 468 |
| | DDR-V | 3 | 7315 | 11143 | 11834 | 12565 | 12935 | 13777 | | 468 |



4296RT-DR-L

STANDARD FEATURES

- Select from 15 standard laminates or choose any standard Wilsonart, Nevamar, Formica, Arborite and Pionite matte finish laminates at no upcharge. For other laminate please contact the factory for pricing.
- 9 standard veneer and hardwood edge stains. Stain-to-match available at no upcharge.
- Standard table height 29".
- All bases are standard with floor leveling glides.

OPTIONS

- Custom heights available.
- For applicable Power & Data modules, please see Table Accessories Price List.

HOW TO ORDER

1. Select Model
2. Select Base
3. Select Edge Style
4. Select Top Finish
5. Select Edge Finish
6. Select Base Finish

Example: 60120BT - DR-L - PVF

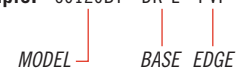



DRUM BASES TABLES BOARDROOM AND CONFERENCE



| MODEL | BASES | | TOP SPECIFICATIONS | | | | | | OPTIONS | LBS |
|------------------|-------|------|--------------------|----------|--------------------|-----------------------------|--------------------------------|-----------------------------|---------|-----|
| | Code | Qty. | For Laminate Top | | | For Veneer Top | | | | |
| | | | SE PVF 2MM | HF HB | HBV HBVR HBG | HF2 HB2 HKNR4 HBG2 | HF HB HBV HBVR HBG | HF2 HB2 HKNR4 HBG2 | | |
| <i>Boatshape</i> | | | | | | | | | | |
| <i>Arc Ends</i> | | | | | | | | | | |
| 42 x 96BTA | HDR-L | 2 | 3707 | 5813 | 6137 | 6471 | 6939 | 7353 | | 235 |
| | HDR-V | 2 | 4063 | 6169 | 6493 | 6827 | 7295 | 7709 | | 235 |
| 48 x 96BTA | HDR-L | 2 | 3707 | 5813 | 6137 | 6471 | 6939 | 7353 | | 235 |
| | HDR-V | 2 | 4063 | 6169 | 6493 | 6827 | 7295 | 7709 | | 235 |
| 48 x 120BTA | DR-L | 2 | 4051 | 6831 | 7231 | 7653 | 7832 | 8307 | | 268 |
| | DR-V | 2 | 4407 | 7187 | 7587 | 8009 | 8188 | 8663 | | 268 |
| | DDR-L | 2 | 4329 | 7109 | 7509 | 7931 | 8110 | 8585 | | 284 |
| | DDR-V | 2 | 4683 | 7463 | 7863 | 8285 | 8464 | 8939 | | 284 |
| 48 x 144BTA | DR-L | 3 | 5497 | 8675 | 9155 | 9661 | 10295 | 10733 | | 302 |
| | DR-V | 3 | 6031 | 9209 | 9689 | 10195 | 10829 | 11267 | | 302 |
| | DDR-L | 3 | 5914 | 9092 | 9572 | 10078 | 10712 | 11150 | | 318 |
| | DDR-V | 3 | 6445 | 9623 | 10103 | 10609 | 11243 | 11681 | | 318 |
| 48 x 168BTA | DR-L | 3 | 6004 | 9444 | 9999 | 10583 | 10879 | 11554 | | 386 |
| | DR-V | 3 | 6538 | 9978 | 10533 | 11117 | 11413 | 12088 | | 386 |
| | DDR-L | 3 | 6286 | 9726 | 10281 | 10865 | 11161 | 11836 | | 410 |
| | DDR-V | 3 | 6817 | 10257 | 10812 | 11396 | 11692 | 12367 | | 410 |



4296RT-HDR-L



4296RT-DR-L

STANDARD FEATURES

- Select from 15 standard laminates or choose any standard Wilsonart, Nevamar, Formica, Arborite and Pionite matte finish laminates at no upcharge. For other laminate please contact the factory for pricing.
- 9 standard veneer and hardwood edge stains. Stain-to-match available at no upcharge.
- Standard table height 29".
- All bases are standard with floor leveling glides.

OPTIONS

- Custom heights available.
- For applicable Power & Data modules, please see Table Accessories Price List.

HOW TO ORDER

1. Select Model
2. Select Base
3. Select Edge Style
4. Select Top Finish
5. Select Edge Finish
6. Select Base Finish

Example: 4296BTA - HDR-L - PVF





DRUM BASES TABLES BOARDROOM AND CONFERENCE



| MODEL | BASES | | TOP SPECIFICATIONS | | | | | | OPTIONS | LBS |
|--------------------|--------------|------|--------------------|----------|--------------------|-----------------------------|--------------------------------|-----------------------------|---------|-----|
| | Code | Qty. | For Laminate Top | | | For Veneer Top | | | | |
| | | | SE PVF 2MM | HF HB | HBV HBVR HBG | HF2 HB2 HKNR4 HBG2 | HF HB HBV HBVR HBG | HF2 HB2 HKNR4 HBG2 | | |
| <i>Boatshape</i> | | | | | | | | | | |
| <i>Arc Ends</i> | | | | | | | | | | |
| 60 x 120BTA | DR-L | 2 | 4543 | 8016 | 8515 | 9042 | 9266 | 9861 | | 310 |
| | DR-V | 2 | 4899 | 8372 | 8871 | 9398 | 9622 | 10217 | | 310 |
| | DDR-L | 2 | 4821 | 8294 | 8793 | 9320 | 9544 | 10139 | | 326 |
| | DDR-V | 2 | 5175 | 8648 | 9147 | 9674 | 9898 | 10493 | | 326 |
| 60 x 144BTA | DR-L | 3 | 6086 | 10061 | 10660 | 11291 | 12087 | 12630 | | 352 |
| | DR-V | 3 | 6620 | 10595 | 11194 | 11825 | 12621 | 13164 | | 352 |
| | DDR-L | 3 | 6503 | 10478 | 11077 | 11708 | 12504 | 13047 | | 368 |
| | DDR-V | 3 | 7034 | 11009 | 11608 | 12239 | 13035 | 13578 | | 368 |
| 60 x 168BTA | DR-L | 3 | 6721 | 11021 | 11713 | 12442 | 12815 | 13659 | | 444 |
| | DR-V | 3 | 7255 | 11555 | 12247 | 12976 | 13349 | 14193 | | 444 |
| | DDR-L | 3 | 7003 | 11303 | 11995 | 12724 | 13097 | 13941 | | 468 |
| | DDR-V | 3 | 7534 | 11834 | 12526 | 13255 | 13628 | 14472 | | 468 |



4296RT-DR-L

STANDARD FEATURES

- Select from 15 standard laminates or choose any standard Wilsonart, Nevamar, Formica, Arborite and Pionite matte finish laminates at no upcharge. For other laminate please contact the factory for pricing.
- 9 standard veneer and hardwood edge stains. Stain-to-match available at no upcharge.
- Standard table height 29".
- All bases are standard with floor leveling glides.

OPTIONS

- Custom heights available.
- For applicable Power & Data modules, please see Table Accessories Price List.

HOW TO ORDER

1. Select Model
2. Select Base
3. Select Edge Style
4. Select Top Finish
5. Select Edge Finish
6. Select Base Finish

Example: 60120BTA - DR-L - PVF



ENDZONE TABLES



PRODUCT CODE

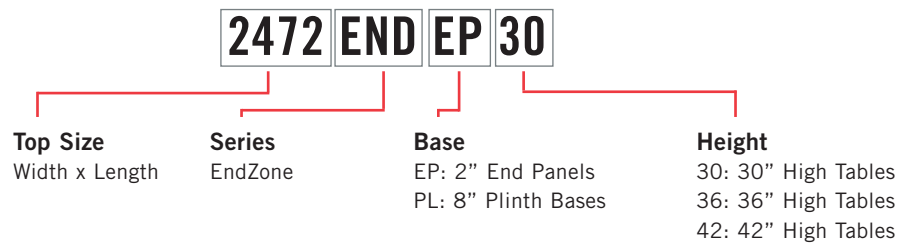

OPTIONS

END PANEL



2" End Panel



8" Plinth Bases

VERTICAL WIRE MANAGER



FOOT REST



FINISHES

LAMINATE



Select from 15 standard laminates or choose any standard Wilsonart, Nevamar, Formica, Arborite and Pionite matte finish laminates at no upcharge. Veneer may be available. Call Factory.

UNDERSURFACE SUPPORT TROUGH



Select from one of our 76 standard Spectone colors

EDGE



See Spectone Card or specfurniture.com/materials/finishes for a complete list of finish options and colors.



ENDZONE TABLES

BACK TO CONTENTS

HOW TO ORDER

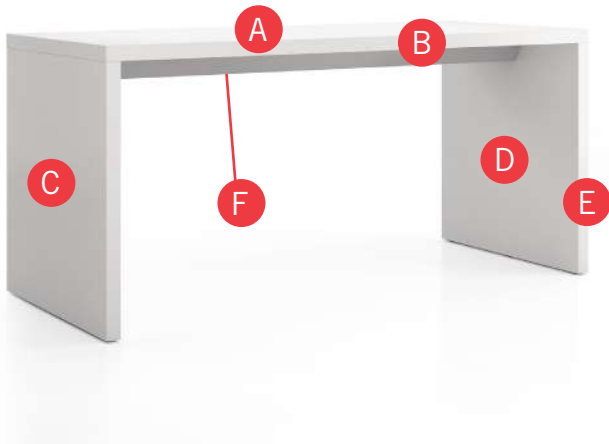

Specify Top Size (Width x Length) and Base Style

- A** Specify Top Surface
For Laminate: Manufacturer, Laminate Name, Laminate Code
- B** Specify Top Edge Type and Finish¹
2mm Bio/2mm PVC Woodgrain/Self Edge
- C** Specify End Panel Outside Surface
For Laminate: Manufacturer, Laminate Name, Laminate Code
- D** Specify End Panel Inside Surface²
For Laminate: Manufacturer, Laminate Name, Laminate Code
- E** Specify End Panel Edge Type and Finish¹
2mm Bio/2mm PVC Woodgrain/Self Edge
- F** Specify Undersurface Support Trough Color

Optional: Power and Data Modules with Rectangular Vertical Wire Manager, Foot Rest, Two Different Laminate Colors

¹ We recommend 2MM edge

² For different laminates between outside and inside surfaces, call factory for pricing

| Top Size and Base Style | Top Surface | Top Edge Type and Finish | End Panel Outside Surface | End Panel Inside Surface | End Panel Edge Type and Color | Trough Color |
|-------------------------|--|--------------------------|--|--|-------------------------------|--------------|
| 36 x 72, ENDEP42 | Laminate, Wilsonart, Designer White, D354-60 | 2mm Bio, RAL 9016 | Laminate, Wilsonart, Designer White, D354-60 | Laminate, Wilsonart, Designer White, D354-60 | 2mm Bio, RAL 9016 | RAL 9016 |

ENDZONE TABLES - 2" END PANELS 30" HIGH

| SIZE | MODEL | | | LIST | OPTIONS | | LBS |
|------------------|--------------|--------|----------------|-----------------|--|------------------------------------|-----|
| Depth x Length | Code | # Legs | # Top Sections | Laminate SE 2MM | VERTICAL WIRE MGR (EACH) <i>Add</i> | FOOT REST (PER SIDE) <i>Add</i> | |
| 24" DEPTH | | | | | | | |
| 24 x 72 | 2472ENDEP30 | 2 | 1 | 3175 | 191 | 511 | 163 |
| 24 x 84 | 2484ENDEP30 | 2 | 1 | 3384 | 191 | 511 | 174 |
| 24 x 96 | 2496ENDEP30 | 2 | 1 | 3473 | 191 | 511 | 186 |
| 24 x 108 | 24108ENDEP30 | 2 | 1 | 5073 | 191 | 511 | 221 |
| 24 x 120 | 24120ENDEP30 | 2 | 1 | 5364 | 191 | 511 | 236 |
| 24 x 144 | 24144ENDEP30 | 3 | 2 | 5476 | 191 | 1022 | 277 |
| 24 x 168 | 24168ENDEP30 | 3 | 2 | 5998 | 191 | 1022 | 300 |
| 24 x 192 | 24192ENDEP30 | 3 | 2 | 8310 | 191 | 1022 | 365 |
| 24 x 216 | 24216ENDEP30 | 3 | 2 | 9548 | 191 | 1022 | 394 |
| 30" DEPTH | | | | | | | |
| 30 x 72 | 3072ENDEP30 | 2 | 1 | 3349 | 191 | 511 | 194 |
| 30 x 84 | 3084ENDEP30 | 2 | 1 | 3697 | 191 | 511 | 207 |
| 30 x 96 | 3096ENDEP30 | 2 | 1 | 3782 | 191 | 511 | 220 |
| 30 x 108 | 30108ENDEP30 | 2 | 1 | 5233 | 191 | 511 | 257 |
| 30 x 120 | 30120ENDEP30 | 2 | 1 | 5524 | 191 | 511 | 273 |
| 30 x 144 | 30144ENDEP30 | 3 | 2 | 5822 | 191 | 1022 | 328 |
| 30 x 168 | 30168ENDEP30 | 3 | 2 | 6625 | 191 | 1022 | 355 |
| 30 x 192 | 30192ENDEP30 | 3 | 2 | 8929 | 191 | 1022 | 423 |
| 30 x 216 | 30216ENDEP30 | 3 | 2 | 9867 | 191 | 1022 | 455 |



ENDEP



On tables with 3 legs, center leg is 18" Deep



Optional Vertical Wire Manager

STANDARD FEATURES

- 2" built up edge
- Select from 15 standard laminates or choose any standard Wilsonart, Nevamar, Formica, Arborite and Pionite matte finish laminates at no upcharge. For other laminate please contact the factory for pricing.
- 2mm Bio edge available in 38 solid colors
- 2mm PVC edge available in wood grain to match 9 standard stains
- 30" height
- Undersurface Support Trough
- Recessed Glides
- Ships Knocked Down

OPTIONS

- Power Access Door, Cove and Villa power modules available, see the end of EndZone tables section
- Rectangular Vertical Wire Manager
- For Solid Core laminate or veneer, call factory for pricing
- Footrest only available in chrome
- For two different laminate colors, call factory for pricing
- Industrial grade locking casters are available Call factory for pricing

HOW TO ORDER

1. Select Size
2. Select Base Style
3. Select Edge Style
4. Select Top Finish
5. Select Edge Finish
6. Select Base Finish
7. Select Metal Finish

Example: 3072- ENDEP - 30 - 2MM -
 DEPTH x LENGTH | BASE | HEIGHT | EDGE



ENDZONE TABLES - 2" END PANELS 30" HIGH

| SIZE | MODEL | | | LIST | OPTIONS | | LBS |
|------------------|--------------|--------|----------------|-----------------|------------------------------|--------------------------|-----|
| Depth x Length | Code | # Legs | # Top Sections | Laminate SE 2MM | VERTICAL WIRE MGR (EACH) Add | FOOT REST (PER SIDE) Add | |
| 36" DEPTH | | | | | | | |
| 36 x 72 | 3672ENDEP30 | 2 | 1 | 3426 | 191 | 511 | 225 |
| 36 x 84 | 3684ENDEP30 | 2 | 1 | 3918 | 191 | 511 | 240 |
| 36 x 96 | 3696ENDEP30 | 2 | 1 | 3981 | 191 | 511 | 255 |
| 36 x 108 | 36108ENDEP30 | 2 | 1 | 5349 | 191 | 511 | 293 |
| 36 x 120 | 36120ENDEP30 | 2 | 1 | 5640 | 191 | 511 | 310 |
| 36 x 144 | 36144ENDEP30 | 3 | 2 | 5977 | 191 | 1022 | 379 |
| 36 x 168 | 36168ENDEP30 | 3 | 2 | 7066 | 191 | 1022 | 409 |
| 36 x 192 | 36192ENDEP30 | 3 | 2 | 9331 | 191 | 1022 | 480 |
| 36 x 216 | 36216ENDEP30 | 3 | 2 | 10067 | 191 | 1022 | 515 |
| 42" DEPTH | | | | | | | |
| 42 x 72 | 4272ENDEP30 | 2 | 1 | 3803 | 191 | 511 | 256 |
| 42 x 84 | 4284ENDEP30 | 2 | 1 | 4232 | 191 | 511 | 272 |
| 42 x 96 | 4296ENDEP30 | 2 | 1 | 4358 | 191 | 511 | 289 |
| 42 x 108 | 42108ENDEP30 | 2 | 1 | 5833 | 191 | 511 | 328 |
| 42 x 120 | 42120ENDEP30 | 2 | 1 | 6124 | 191 | 511 | 348 |
| 42 x 144 | 42144ENDEP30 | 3 | 2 | 6732 | 191 | 1023 | 430 |
| 42 x 168 | 42168ENDEP30 | 3 | 2 | 7694 | 191 | 1023 | 463 |
| 42 x 192 | 42192ENDEP30 | 3 | 2 | 10081 | 191 | 1023 | 538 |
| 42 x 216 | 42216ENDEP30 | 3 | 2 | 11066 | 191 | 1023 | 576 |



STANDARD FEATURES

- 2" built up edge
- Select from 15 standard laminates or choose any standard Wilsonart, Nevamar, Formica, Arborite and Pionite matte finish laminates at no upcharge. For other laminate please contact the factory for pricing.
- 2mm Bio edge available in 38 solid colors
- 2mm PVC edge available in wood grain to match 9 standard stains
- 30" height
- Undersurface Support Trough
- Recessed Glides
- Ships Knocked Down

OPTIONS

- Power Access Door, Cove and Villa power modules available, see the end of EndZone tables section
- Rectangular Vertical Wire Manager
- For Solid Core laminate or veneer, call factory for pricing
- Footrest only available in chrome
- For two different laminate colors, call factory for pricing
- Industrial grade locking casters are available Call factory for pricing

HOW TO ORDER

1. Select Size
2. Select Base Style
3. Select Edge Style
4. Select Top Finish
5. Select Edge Finish
6. Select Base Finish
7. Select Metal Finish

Example: 3072- ENDEP - 30 - 2MM -
 DEPTH x LENGTH | BASE | HEIGHT | EDGE



BACK TO CONTENTS

ENDZONE TABLES - 2" END PANELS

36" HIGH

| SIZE | MODEL | | | LIST | OPTIONS | | LBS |
|-----------------------|--------------|---------------|-----------------------|------------------------|---|---|-----|
| <i>Depth x Length</i> | <i>Code</i> | <i># Legs</i> | <i># Top Sections</i> | <i>Laminate SE 2MM</i> | VERTICAL WIRE MGR (EACH) <i>Add</i> | FOOT REST (PER SIDE) <i>Add</i> | |
| 24" DEPTH | | | | | | | |
| 24 x 72 | 2472ENDEP36 | 2 | 1 | 3343 | 191 | 511 | 167 |
| 24 x 84 | 2484ENDEP36 | 2 | 1 | 3552 | 191 | 511 | 179 |
| 24 x 96 | 2496ENDEP36 | 2 | 1 | 3641 | 191 | 511 | 191 |
| 24 x 108 | 24108ENDEP36 | 2 | 1 | 5241 | 191 | 511 | 227 |
| 24 x 120 | 24120ENDEP36 | 2 | 1 | 5532 | 191 | 511 | 241 |
| 24 x 144 | 24144ENDEP36 | 3 | 2 | 5728 | 191 | 1022 | 284 |
| 24 x 168 | 24168ENDEP36 | 3 | 2 | 6250 | 191 | 1022 | 308 |
| 24 x 192 | 24192ENDEP36 | 3 | 2 | 8562 | 191 | 1022 | 374 |
| 24 x 216 | 24216ENDEP36 | 3 | 2 | 9800 | 191 | 1022 | 404 |
| 30" DEPTH | | | | | | | |
| 30 x 72 | 3072ENDEP36 | 2 | 1 | 3517 | 191 | 511 | 198 |
| 30 x 84 | 3084ENDEP36 | 2 | 1 | 3865 | 191 | 511 | 212 |
| 30 x 96 | 3096ENDEP36 | 2 | 1 | 3950 | 191 | 511 | 226 |
| 30 x 108 | 30108ENDEP36 | 2 | 1 | 5401 | 191 | 511 | 263 |
| 30 x 120 | 30120ENDEP36 | 2 | 1 | 5692 | 191 | 511 | 280 |
| 30 x 144 | 30144ENDEP36 | 3 | 2 | 6074 | 191 | 1022 | 336 |
| 30 x 168 | 30168ENDEP36 | 3 | 2 | 6877 | 191 | 1022 | 363 |
| 30 x 192 | 30192ENDEP36 | 3 | 2 | 9181 | 191 | 1022 | 433 |
| 30 x 216 | 30216ENDEP36 | 3 | 2 | 10119 | 191 | 1022 | 466 |



STANDARD FEATURES

- 2" built up edge
- Select from 15 standard laminates or choose any standard Wilsonart, Nevamar, Formica, Arborite and Pionite matte finish laminates at no upcharge. For other laminate please contact the factory for pricing.
- 2mm Bio edge available in 38 solid colors
- 2mm PVC edge available in wood grain to match 9 standard stains
- 36" height
- Undersurface Support Trough
- Recessed Glides
- Ships Knocked Down

OPTIONS

- Power Access Door, Cove and Villa power modules available, see the end of EndZone tables section
- Rectangular Vertical Wire Manager
- For Solid Core laminate or veneer, call factory for pricing
- Footrest only available in chrome
- For two different laminate colors, call factory for pricing
- Industrial grade locking casters are available Call factory for pricing

HOW TO ORDER

1. Select Size
2. Select Base Style
3. Select Edge Style
4. Select Top Finish
5. Select Edge Finish
6. Select Base Finish
7. Select Metal Finish

Example: 3072- ENDEP - 30 - 2MM -
 DEPTH x LENGTH | BASE | HEIGHT | EDGE



ENDZONE TABLES - 2" END PANELS 36" HIGH

| SIZE | MODEL | | | LIST | OPTIONS | | LBS |
|-----------------------|--------------|---------------|-----------------------|------------------------|-------------------------------------|---------------------------------|-----|
| <i>Depth x Length</i> | <i>Code</i> | <i># Legs</i> | <i># Top Sections</i> | <i>Laminate SE 2MM</i> | <i>VERTICAL WIRE MGR (EACH) Add</i> | <i>FOOT REST (PER SIDE) Add</i> | |
| 36" DEPTH | | | | | | | |
| 36 x 72 | 3672ENDEP36 | 2 | 1 | 3594 | 191 | 511 | 230 |
| 36 x 84 | 3684ENDEP36 | 2 | 1 | 4086 | 191 | 511 | 245 |
| 36 x 96 | 3696ENDEP36 | 2 | 1 | 4149 | 191 | 511 | 261 |
| 36 x 108 | 36108ENDEP36 | 2 | 1 | 5517 | 191 | 511 | 300 |
| 36 x 120 | 36120ENDEP36 | 2 | 1 | 5808 | 191 | 511 | 318 |
| 36 x 144 | 36144ENDEP36 | 3 | 2 | 6229 | 191 | 1022 | 388 |
| 36 x 168 | 36168ENDEP36 | 3 | 2 | 7318 | 191 | 1022 | 419 |
| 36 x 192 | 36192ENDEP36 | 3 | 2 | 9583 | 191 | 1022 | 492 |
| 36 x 216 | 36216ENDEP36 | 3 | 2 | 10319 | 191 | 1022 | 528 |
| 42" DEPTH | | | | | | | |
| 42 x 72 | 4272ENDEP36 | 2 | 1 | 3971 | 191 | 511 | 262 |
| 42 x 84 | 4284ENDEP36 | 2 | 1 | 4400 | 191 | 511 | 279 |
| 42 x 96 | 4296ENDEP36 | 2 | 1 | 4526 | 191 | 511 | 296 |
| 42 x 108 | 42108ENDEP36 | 2 | 1 | 6001 | 191 | 511 | 336 |
| 42 x 120 | 42120ENDEP36 | 2 | 1 | 6292 | 191 | 511 | 356 |
| 42 x 144 | 42144ENDEP36 | 3 | 2 | 6984 | 191 | 1022 | 441 |
| 42 x 168 | 42168ENDEP36 | 3 | 2 | 7946 | 191 | 1022 | 475 |
| 42 x 192 | 42192ENDEP36 | 3 | 2 | 10333 | 191 | 1022 | 551 |
| 42 x 216 | 42216ENDEP36 | 3 | 2 | 11318 | 191 | 1022 | 590 |



STANDARD FEATURES

- 2" built up edge
- Select from 15 standard laminates or choose any standard Wilsonart, Nevamar, Formica, Arborite and Pionite matte finish laminates at no upcharge. For other laminate please contact the factory for pricing.
- 2mm Bio edge available in 38 solid colors
- 2mm PVC edge available in wood grain to match 9 standard stains
- 36" height
- Undersurface Support Trough
- Recessed Glides
- Ships Knocked Down

OPTIONS

- Power Access Door, Cove and Villa power modules available, see the end of EndZone tables section
- Rectangular Vertical Wire Manager
- For Solid Core laminate or veneer, call factory for pricing
- Footrest only available in chrome
- For two different laminate colors, call factory for pricing
- Industrial grade locking casters are available Call factory for pricing

HOW TO ORDER

1. Select Size
2. Select Base Style
3. Select Edge Style
4. Select Top Finish
5. Select Edge Finish
6. Select Base Finish
7. Select Metal Finish

Example: 3072- ENDEP - 30 - 2MM -
 DEPTH x LENGTH | BASE | HEIGHT | EDGE



ENDZONE TABLES - 2" END PANELS 42" HIGH



| SIZE | MODEL | | | LIST | OPTIONS | | LBS |
|------------------|--------------|--------|----------------|-----------------|--|------------------------------------|-----|
| Depth x Length | Code | # Legs | # Top Sections | Laminate SE 2MM | VERTICAL WIRE MGR (EACH) <i>Add</i> | FOOT REST (PER SIDE) <i>Add</i> | |
| 24" DEPTH | | | | | | | |
| 24 x 72 | 2472ENDEP42 | 2 | 1 | 3343 | 191 | 511 | 171 |
| 24 x 84 | 2484ENDEP42 | 2 | 1 | 3552 | 191 | 511 | 183 |
| 24 x 96 | 2496ENDEP42 | 2 | 1 | 3641 | 191 | 511 | 196 |
| 24 x 108 | 24108ENDEP42 | 2 | 1 | 5241 | 191 | 511 | 232 |
| 24 x 120 | 24120ENDEP42 | 2 | 1 | 5532 | 191 | 511 | 247 |
| 24 x 144 | 24144ENDEP42 | 3 | 2 | 5728 | 191 | 1022 | 291 |
| 24 x 168 | 24168ENDEP42 | 3 | 2 | 6250 | 191 | 1022 | 315 |
| 24 x 192 | 24192ENDEP42 | 3 | 2 | 8562 | 191 | 1022 | 383 |
| 24 x 216 | 24216ENDEP42 | 3 | 2 | 9800 | 191 | 1022 | 414 |
| 30" DEPTH | | | | | | | |
| 30 x 72 | 3072ENDEP42 | 2 | 1 | 3517 | 191 | 511 | 203 |
| 30 x 84 | 3084ENDEP42 | 2 | 1 | 3865 | 191 | 511 | 217 |
| 30 x 96 | 3096ENDEP42 | 2 | 1 | 3950 | 191 | 511 | 231 |
| 30 x 108 | 30108ENDEP42 | 2 | 1 | 5401 | 191 | 511 | 270 |
| 30 x 120 | 30120ENDEP42 | 2 | 1 | 5692 | 191 | 511 | 287 |
| 30 x 144 | 30144ENDEP42 | 3 | 2 | 6074 | 191 | 1022 | 344 |
| 30 x 168 | 30168ENDEP42 | 3 | 2 | 6877 | 191 | 1022 | 372 |
| 30 x 192 | 30192ENDEP42 | 3 | 2 | 9181 | 191 | 1022 | 444 |
| 30 x 216 | 30216ENDEP42 | 3 | 2 | 10119 | 191 | 1022 | 477 |



STANDARD FEATURES

- 2" built up edge
- Select from 15 standard laminates or choose any standard Wilsonart, Nevamar, Formica, Arborite and Pionite matte finish laminates at no upcharge. For other laminate please contact the factory for pricing.
- 2mm Bio edge available in 38 solid colors
- 2mm PVC edge available in wood grain to match 9 standard stains
- 42" height
- Undersurface Support Trough
- Recessed Glides
- Ships Knocked Down

OPTIONS

- Power Access Door, Cove and Villa power modules available, see the end of EndZone tables section
- Rectangular Vertical Wire Manager
- For Solid Core laminate or veneer, call factory for pricing
- Footrest only available in chrome
- For two different laminate colors, call factory for pricing
- Industrial grade locking casters are available Call factory for pricing

HOW TO ORDER

1. Select Size
2. Select Base Style
3. Select Edge Style
4. Select Top Finish
5. Select Edge Finish
6. Select Base Finish
7. Select Metal Finish

Example: 3072- ENDEP - 30 - 2MM -
 DEPTH x LENGTH | BASE | HEIGHT | EDGE



ENDZONE TABLES - 2" END PANELS 42" HIGH

| SIZE | MODEL | | | LIST | OPTIONS | | LBS |
|------------------|--------------|--------|----------------|-----------------|--|------------------------------------|-----|
| Depth x Length | Code | # Legs | # Top Sections | Laminate SE 2MM | VERTICAL WIRE MGR (EACH) <i>Add</i> | FOOT REST (PER SIDE) <i>Add</i> | |
| 36" DEPTH | | | | | | | |
| 36 x 72 | 3672ENDEP42 | 2 | 1 | 3594 | 191 | 511 | 236 |
| 36 x 84 | 3684ENDEP42 | 2 | 1 | 4086 | 191 | 511 | 252 |
| 36 x 96 | 3696ENDEP42 | 2 | 1 | 4149 | 191 | 511 | 267 |
| 36 x 108 | 36108ENDEP42 | 2 | 1 | 5517 | 191 | 511 | 307 |
| 36 x 120 | 36120ENDEP42 | 2 | 1 | 5808 | 191 | 511 | 326 |
| 36 x 144 | 36144ENDEP42 | 3 | 2 | 6229 | 191 | 1022 | 398 |
| 36 x 168 | 36168ENDEP42 | 3 | 2 | 7318 | 191 | 1022 | 430 |
| 36 x 192 | 36192ENDEP42 | 3 | 2 | 9583 | 191 | 1022 | 504 |
| 36 x 216 | 36216ENDEP42 | 3 | 2 | 10319 | 191 | 1022 | 541 |
| 42" DEPTH | | | | | | | |
| 42 x 72 | 4272ENDEP42 | 2 | 1 | 3971 | 191 | 511 | 268 |
| 42 x 84 | 4284ENDEP42 | 2 | 1 | 4400 | 191 | 511 | 286 |
| 42 x 96 | 4296ENDEP42 | 2 | 1 | 4526 | 191 | 511 | 303 |
| 42 x 108 | 42108ENDEP42 | 2 | 1 | 6001 | 191 | 511 | 345 |
| 42 x 120 | 42120ENDEP42 | 2 | 1 | 6292 | 191 | 511 | 365 |
| 42 x 144 | 42144ENDEP42 | 3 | 2 | 6984 | 191 | 1022 | 452 |
| 42 x 168 | 42168ENDEP42 | 3 | 2 | 7946 | 191 | 1022 | 487 |
| 42 x 192 | 42192ENDEP42 | 3 | 2 | 10333 | 191 | 1022 | 565 |
| 42 x 216 | 42216ENDEP42 | 3 | 2 | 11318 | 191 | 1022 | 605 |



STANDARD FEATURES

- 2" built up edge
- Select from 15 standard laminates or choose any standard Wilsonart, Nevamar, Formica, Arborite and Pionite matte finish laminates at no upcharge. For other laminate please contact the factory for pricing.
- 2mm Bio edge available in 38 solid colors
- 2mm PVC edge available in wood grain to match 9 standard stains
- 42" height
- Undersurface Support Trough
- Recessed Glides
- Ships Knocked Down

OPTIONS

- Power Access Door, Cove and Villa power modules available, see the end of EndZone tables section
- Rectangular Vertical Wire Manager
- For Solid Core laminate or veneer, call factory for pricing
- Footrest only available in chrome
- For two different laminate colors, call factory for pricing
- Industrial grade locking casters are available Call factory for pricing

HOW TO ORDER

1. Select Size
2. Select Base Style
3. Select Edge Style
4. Select Top Finish
5. Select Edge Finish
6. Select Base Finish
7. Select Metal Finish

Example: 3072- ENDEP - 30 - 2MM -
 DEPTH x LENGTH | BASE | HEIGHT | EDGE

ENDZONE TABLES - 8" PLINTH BASES 30" HIGH



| SIZE | MODEL | | | LIST | OPTIONS | LBS |
|------------------|--------------|--------|----------------|-----------------|------------------------------------|-----|
| Depth x Length | Code | # Legs | # Top Sections | Laminate SE 2MM | FOOT REST (PER SIDE) <i>Add</i> | |
| 24" DEPTH | | | | | | |
| 24 x 72 | 2472ENDPL30 | 2 | 1 | 3311 | 511 | 176 |
| 24 x 84 | 2484ENDPL30 | 2 | 1 | 3520 | 511 | 187 |
| 24 x 96 | 2496ENDPL30 | 2 | 1 | 3609 | 511 | 199 |
| 24 x 108 | 24108ENDPL30 | 2 | 1 | 5209 | 511 | 234 |
| 24 x 120 | 24120ENDPL30 | 2 | 1 | 5500 | 511 | 249 |
| 24 x 144 | 24144ENDPL30 | 3 | 2 | 5680 | 1022 | 296 |
| 24 x 168 | 24168ENDPL30 | 3 | 2 | 6202 | 1022 | 320 |
| 24 x 192 | 24192ENDPL30 | 3 | 2 | 8514 | 1022 | 385 |
| 24 x 216 | 24216ENDPL30 | 3 | 2 | 9752 | 1022 | 413 |
| 30" DEPTH | | | | | | |
| 30 x 72 | 3072ENDPL30 | 2 | 1 | 3485 | 511 | 210 |
| 30 x 84 | 3084ENDPL30 | 2 | 1 | 3833 | 511 | 223 |
| 30 x 96 | 3096ENDPL30 | 2 | 1 | 3918 | 511 | 237 |
| 30 x 108 | 30108ENDPL30 | 2 | 1 | 5369 | 511 | 273 |
| 30 x 120 | 30120ENDPL30 | 2 | 1 | 5660 | 511 | 289 |
| 30 x 144 | 30144ENDPL30 | 3 | 2 | 6026 | 1022 | 352 |
| 30 x 168 | 30168ENDPL30 | 3 | 2 | 6829 | 1022 | 379 |
| 30 x 192 | 30192ENDPL30 | 3 | 2 | 9133 | 1022 | 447 |
| 30 x 216 | 30216ENDPL30 | 3 | 2 | 10071 | 1022 | 479 |



STANDARD FEATURES

- 2" built up edge
- Select from 15 standard laminates or choose any standard Wilsonart, Nevamar, Formica, Arborite and Pionite matte finish laminates at no upcharge. For other laminate please contact the factory for pricing.
- 2mm Bio edge available in 38 solid colors
- 2mm PVC edge available in wood grain to match 9 standard stains
- 30" height
- Undersurface Support Trough
- Recessed Glides
- Ships Knocked Down

OPTIONS

- Specify power modules for EndZone. Power Access Door, Cove and Villa power modules available, see the end of EndZone tables section
- Rectangular Vertical Wire Manager
- For Solid Core laminate or veneer, call factory for pricing
- Foot Rest only available in chrome
- For two different laminate colors, call factory for pricing

HOW TO ORDER

1. Select Size
2. Select Base Style
3. Select Edge Style
4. Select Top Finish
5. Select Edge Finish
6. Select Base Finish
7. Select Metal Finish

Example: 3072- ENDEP - 30 - 2MM -

DEPTH x LENGTH | BASE | HEIGHT | EDGE



ENDZONE TABLES - 8" PLINTH BASES 30" HIGH



| SIZE | MODEL | | | LIST | OPTIONS | LBS |
|------------------|--------------|--------|----------------|-----------------|------------------------------------|-----|
| Depth x Length | Code | # Legs | # Top Sections | Laminate SE 2MM | FOOT REST (PER SIDE) <i>Add</i> | |
| 36" DEPTH | | | | | | |
| 36 x 72 | 3672ENDPL30 | 2 | 1 | 3562 | 511 | 244 |
| 36 x 84 | 3684ENDPL30 | 2 | 1 | 4054 | 511 | 259 |
| 36 x 96 | 3696ENDPL30 | 2 | 1 | 4117 | 511 | 274 |
| 36 x 108 | 36108ENDPL30 | 2 | 1 | 5485 | 511 | 312 |
| 36 x 120 | 36120ENDPL30 | 2 | 1 | 5776 | 511 | 330 |
| 36 x 144 | 36144ENDPL30 | 3 | 2 | 6181 | 1022 | 408 |
| 36 x 168 | 36168ENDPL30 | 3 | 2 | 7270 | 1022 | 438 |
| 36 x 192 | 36192ENDPL30 | 3 | 2 | 9535 | 1022 | 509 |
| 36 x 216 | 36216ENDPL30 | 3 | 2 | 10271 | 1022 | 544 |
| 42" DEPTH | | | | | | |
| 42 x 72 | 4272ENDPL30 | 2 | 1 | 3939 | 511 | 278 |
| 42 x 84 | 4284ENDPL30 | 2 | 1 | 4368 | 511 | 295 |
| 42 x 96 | 4296ENDPL30 | 2 | 1 | 4494 | 511 | 311 |
| 42 x 108 | 42108ENDPL30 | 2 | 1 | 5969 | 511 | 351 |
| 42 x 120 | 42120ENDPL30 | 2 | 1 | 6260 | 511 | 370 |
| 42 x 144 | 42144ENDPL30 | 3 | 2 | 6936 | 1022 | 464 |
| 42 x 168 | 42168ENDPL30 | 3 | 2 | 7898 | 1022 | 497 |
| 42 x 192 | 42192ENDPL30 | 3 | 2 | 10285 | 1022 | 572 |
| 42 x 216 | 42216ENDPL30 | 3 | 2 | 11270 | 1022 | 610 |



STANDARD FEATURES

- 2" built up edge
- Select from 15 standard laminates or choose any standard Wilsonart, Nevamar, Formica, Arborite and Pionite matte finish laminates at no upcharge. For other laminate please contact the factory for pricing.
- 2mm Bio edge available in 38 solid colors
- 2mm PVC edge available in wood grain to match 9 standard stains
- 30" height
- Undersurface Support Trough
- Recessed Glides
- Ships Knocked Down

OPTIONS

- Specify power modules for EndZone. Power Access Door, Cove and Villa power modules available, see the end of EndZone tables section
- Rectangular Vertical Wire Manager
- For Solid Core laminate or veneer, call factory for pricing
- Foot Rest only available in chrome
- For two different laminate colors, call factory for pricing

HOW TO ORDER

1. Select Size
2. Select Base Style
3. Select Edge Style
4. Select Top Finish
5. Select Edge Finish
6. Select Base Finish
7. Select Metal Finish

Example: 3072- ENDEP - 30 - 2MM -

DEPTH x LENGTH | BASE | HEIGHT | EDGE

ENDZONE TABLES - 8" PLINTH BASES 36" HIGH



| SIZE | MODEL | | | LIST | OPTIONS | LBS |
|------------------|--------------|--------|----------------|-----------------|------------------------------------|-----|
| Depth x Length | Code | # Legs | # Top Sections | Laminate SE 2MM | FOOT REST (PER SIDE) <i>Add</i> | |
| 24" DEPTH | | | | | | |
| 24 x 72 | 2472ENDPL36 | 2 | 1 | 3495 | 511 | 180 |
| 24 x 84 | 2484ENDPL36 | 2 | 1 | 3704 | 511 | 192 |
| 24 x 96 | 2496ENDPL36 | 2 | 1 | 3793 | 511 | 204 |
| 24 x 108 | 24108ENDPL36 | 2 | 1 | 5393 | 511 | 240 |
| 24 x 120 | 24120ENDPL36 | 2 | 1 | 5684 | 511 | 255 |
| 24 x 144 | 24144ENDPL36 | 3 | 2 | 5956 | 1022 | 304 |
| 24 x 168 | 24168ENDPL36 | 3 | 2 | 6478 | 1022 | 328 |
| 24 x 192 | 24192ENDPL36 | 3 | 2 | 8790 | 1022 | 394 |
| 24 x 216 | 24216ENDPL36 | 3 | 2 | 10028 | 1022 | 424 |
| 30" DEPTH | | | | | | |
| 30 x 72 | 3072ENDPL36 | 2 | 1 | 3669 | 511 | 215 |
| 30 x 84 | 3084ENDPL36 | 2 | 1 | 4017 | 511 | 229 |
| 30 x 96 | 3096ENDPL36 | 2 | 1 | 4102 | 511 | 242 |
| 30 x 108 | 30108ENDPL36 | 2 | 1 | 5553 | 511 | 280 |
| 30 x 120 | 30120ENDPL36 | 2 | 1 | 5844 | 511 | 296 |
| 30 x 144 | 30144ENDPL36 | 3 | 2 | 6302 | 1022 | 361 |
| 30 x 168 | 30168ENDPL36 | 3 | 2 | 7105 | 1022 | 388 |
| 30 x 192 | 30192ENDPL36 | 3 | 2 | 9409 | 1022 | 458 |
| 30 x 216 | 30216ENDPL36 | 3 | 2 | 10347 | 1022 | 491 |



ENDPL



On tables with 3 legs, center leg is 18" Deep

STANDARD FEATURES

- 2" built up edge
- Select from 15 standard laminates or choose any standard Wilsonart, Nevamar, Formica, Arborite and Pionite matte finish laminates at no upcharge. For other laminate please contact the factory for pricing.
- 2mm Bio edge available in 38 solid colors
- 2mm PVC edge available in wood grain to match 9 standard stains
- 36" height
- Undersurface Support Trough
- Recessed Glides
- Ships Knocked Down

OPTIONS

- Specify power modules for EndZone. Power Access Door, Cove and Villa power modules available, see the end of EndZone tables section
- Rectangular Vertical Wire Manager
- For Solid Core laminate or veneer, call factory for pricing
- Foot Rest only available in chrome
- For two different laminate colors, call factory for pricing

HOW TO ORDER

1. Select Size
2. Select Base Style
3. Select Edge Style
4. Select Top Finish
5. Select Edge Finish
6. Select Base Finish
7. Select Metal Finish

Example: 3072- ENDEP - 30 - 2MM -
 DEPTH x LENGTH | BASE | HEIGHT | EDGE

ENDZONE TABLES - 8" PLINTH BASES 36" HIGH



| SIZE | MODEL | | | LIST | OPTIONS | LBS |
|------------------|--------------|--------|----------------|-----------------|------------------------------------|-----|
| Depth x Length | Code | # Legs | # Top Sections | Laminate SE 2MM | FOOT REST (PER SIDE) <i>Add</i> | |
| 36" DEPTH | | | | | | |
| 36 x 72 | 3672ENDPL36 | 2 | 1 | 3746 | 511 | 250 |
| 36 x 84 | 3684ENDPL36 | 2 | 1 | 4238 | 511 | 265 |
| 36 x 96 | 3696ENDPL36 | 2 | 1 | 4301 | 511 | 281 |
| 36 x 108 | 36108ENDPL36 | 2 | 1 | 5669 | 511 | 320 |
| 36 x 120 | 36120ENDPL36 | 2 | 1 | 5960 | 511 | 338 |
| 36 x 144 | 36144ENDPL36 | 3 | 2 | 6457 | 1022 | 418 |
| 36 x 168 | 36168ENDPL36 | 3 | 2 | 7546 | 1022 | 449 |
| 36 x 192 | 36192ENDPL36 | 3 | 2 | 9811 | 1022 | 522 |
| 36 x 216 | 36216ENDPL36 | 3 | 2 | 10547 | 1022 | 558 |
| 42" DEPTH | | | | | | |
| 42 x 72 | 4272ENDPL36 | 2 | 1 | 4123 | 511 | 285 |
| 42 x 84 | 4284ENDPL36 | 2 | 1 | 4552 | 511 | 302 |
| 42 x 96 | 4296ENDPL36 | 2 | 1 | 4678 | 511 | 319 |
| 42 x 108 | 42108ENDPL36 | 2 | 1 | 6153 | 511 | 360 |
| 42 x 120 | 42120ENDPL36 | 2 | 1 | 6444 | 511 | 379 |
| 42 x 144 | 42144ENDPL36 | 3 | 2 | 7212 | 1022 | 476 |
| 42 x 168 | 42168ENDPL36 | 3 | 2 | 8174 | 1022 | 509 |
| 42 x 192 | 42192ENDPL36 | 3 | 2 | 10561 | 1022 | 586 |
| 42 x 216 | 42216ENDPL36 | 3 | 2 | 11546 | 1022 | 625 |



STANDARD FEATURES

- 2" built up edge
- Select from 15 standard laminates or choose any standard Wilsonart, Nevamar, Formica, Arborite and Pionite matte finish laminates at no upcharge. For other laminate please contact the factory for pricing.
- 2mm Bio edge available in 38 solid colors
- 2mm PVC edge available in wood grain to match 9 standard stains
- 36" height
- Undersurface Support Trough
- Recessed Glides
- Ships Knocked Down

OPTIONS

- Specify power modules for EndZone. Power Access Door, Cove and Villa power modules available, see the end of EndZone tables section
- Rectangular Vertical Wire Manager
- For Solid Core laminate or veneer, call factory for pricing
- Foot Rest only available in chrome
- For two different laminate colors, call factory for pricing

HOW TO ORDER

1. Select Size
2. Select Base Style
3. Select Edge Style
4. Select Top Finish
5. Select Edge Finish
6. Select Base Finish
7. Select Metal Finish

Example: 3072- ENDEP - 30 - 2MM -
 DEPTH x LENGTH | BASE | HEIGHT | EDGE



ENDZONE TABLES - 8" PLINTH BASES 42" HIGH



| SIZE | MODEL | | | LIST | OPTIONS | LBS |
|------------------|--------------|--------|----------------|-----------------------|------------------------------------|-----|
| Depth x Length | Code | # Legs | # Top Sections | Laminate SE 2MM | FOOT REST (PER SIDE) Add | |
| 24" DEPTH | | | | | | |
| 24 x 72 | 2472ENDPL42 | 2 | 1 | 3495 | 511 | 184 |
| 24 x 84 | 2484ENDPL42 | 2 | 1 | 3704 | 511 | 197 |
| 24 x 96 | 2496ENDPL42 | 2 | 1 | 3793 | 511 | 209 |
| 24 x 108 | 24108ENDPL42 | 2 | 1 | 5393 | 511 | 246 |
| 24 x 120 | 24120ENDPL42 | 2 | 1 | 5684 | 511 | 261 |
| 24 x 144 | 24144ENDPL42 | 3 | 2 | 5956 | 1022 | 311 |
| 24 x 168 | 24168ENDPL42 | 3 | 2 | 6478 | 1022 | 336 |
| 24 x 192 | 24192ENDPL42 | 3 | 2 | 8790 | 1022 | 404 |
| 24 x 216 | 24216ENDPL42 | 3 | 2 | 10028 | 1022 | 434 |
| 30" DEPTH | | | | | | |
| 30 x 72 | 3072ENDPL42 | 2 | 1 | 3669 | 511 | 220 |
| 30 x 84 | 3084ENDPL42 | 2 | 1 | 4017 | 511 | 234 |
| 30 x 96 | 3096ENDPL42 | 2 | 1 | 4102 | 511 | 248 |
| 30 x 108 | 30108ENDPL42 | 2 | 1 | 5553 | 511 | 287 |
| 30 x 120 | 30120ENDPL42 | 2 | 1 | 5844 | 511 | 304 |
| 30 x 144 | 30144ENDPL42 | 3 | 2 | 6302 | 1022 | 370 |
| 30 x 168 | 30168ENDPL42 | 3 | 2 | 7105 | 1022 | 398 |
| 30 x 192 | 30192ENDPL42 | 3 | 2 | 9409 | 1022 | 469 |
| 30 x 216 | 30216ENDPL42 | 3 | 2 | 10347 | 1022 | 503 |



STANDARD FEATURES

- 2" built up edge
- Select from 15 standard laminates or choose any standard Wilsonart, Nevamar, Formica, Arborite and Pionite matte finish laminates at no upcharge. For other laminate please contact the factory for pricing.
- 2mm Bio edge available in 38 solid colors
- 2mm PVC edge available in wood grain to match 9 standard stains
- 42" height
- Undersurface Support Trough
- Recessed Glides
- Ships Knocked Down

OPTIONS

- Specify power modules for EndZone. Power Access Door, Cove and Villa power modules available, see the end of EndZone tables section
- Rectangular Vertical Wire Manager
- For Solid Core laminate or veneer, call factory for pricing
- Foot Rest only available in chrome
- For two different laminate colors, call factory for pricing

HOW TO ORDER

1. Select Size
2. Select Base Style
3. Select Edge Style
4. Select Top Finish
5. Select Edge Finish
6. Select Base Finish
7. Select Metal Finish

Example: 3072- ENDEP - 30 - 2MM -
 DEPTH x LENGTH | BASE | HEIGHT | EDGE



BACK TO CONTENTS

ENDZONE TABLES - 8" PLINTH BASES 42" HIGH



| SIZE | MODEL | | | LIST | OPTIONS | LBS |
|------------------|--------------|--------|----------------|-----------------|------------------------------------|-----|
| Depth x Length | Code | # Legs | # Top Sections | Laminate SE 2MM | FOOT REST (PER SIDE) <i>Add</i> | |
| 36" DEPTH | | | | | | |
| 36 x 72 | 3672ENDPL42 | 2 | 1 | 3746 | 511 | 256 |
| 36 x 84 | 3684ENDPL42 | 2 | 1 | 4238 | 511 | 272 |
| 36 x 96 | 3696ENDPL42 | 2 | 1 | 4301 | 511 | 288 |
| 36 x 108 | 36108ENDPL42 | 2 | 1 | 5669 | 511 | 328 |
| 36 x 120 | 36120ENDPL42 | 2 | 1 | 5960 | 511 | 346 |
| 36 x 144 | 36144ENDPL42 | 3 | 2 | 6457 | 1022 | 429 |
| 36 x 168 | 36168ENDPL42 | 3 | 2 | 7546 | 1022 | 460 |
| 36 x 192 | 36192ENDPL42 | 3 | 2 | 9811 | 1022 | 535 |
| 36 x 216 | 36216ENDPL42 | 3 | 2 | 10547 | 1022 | 572 |
| 42" DEPTH | | | | | | |
| 42 x 72 | 4272ENDPL42 | 2 | 1 | 4123 | 511 | 292 |
| 42 x 84 | 4284ENDPL42 | 2 | 1 | 4552 | 511 | 310 |
| 42 x 96 | 4296ENDPL42 | 2 | 1 | 4678 | 511 | 327 |
| 42 x 108 | 42108ENDPL42 | 2 | 1 | 6153 | 511 | 369 |
| 42 x 120 | 42120ENDPL42 | 2 | 1 | 6444 | 511 | 389 |
| 42 x 144 | 42144ENDPL42 | 3 | 2 | 7212 | 1022 | 487 |
| 42 x 168 | 42168ENDPL42 | 3 | 2 | 8174 | 1022 | 522 |
| 42 x 192 | 42192ENDPL42 | 3 | 2 | 10561 | 1022 | 600 |
| 42 x 216 | 42216ENDPL42 | 3 | 2 | 11546 | 1022 | 640 |



ENDPL



On tables with 3 legs, center leg is 18" Deep

STANDARD FEATURES

- 2" built up edge
- Select from 15 standard laminates or choose any standard Wilsonart, Nevamar, Formica, Arborite and Pionite matte finish laminates at no upcharge. For other laminate please contact the factory for pricing.
- 2mm Bio edge available in 38 solid colors
- 2mm PVC edge available in wood grain to match 9 standard stains
- 42" height
- Undersurface Support Trough
- Recessed Glides
- Ships Knocked Down

OPTIONS

- Specify power modules for EndZone. Power Access Door, Cove and Villa power modules available, see the end of EndZone tables section
- Rectangular Vertical Wire Manager
- For Solid Core laminate or veneer, call factory for pricing
- Foot Rest only available in chrome
- For two different laminate colors, call factory for pricing

HOW TO ORDER

1. Select Size
2. Select Base Style
3. Select Edge Style
4. Select Top Finish
5. Select Edge Finish
6. Select Base Finish
7. Select Metal Finish

Example: 3072- ENDEP - 30 - 2MM -
 DEPTH x LENGTH | BASE | HEIGHT | EDGE

ENDZONE TABLES POWER & COMMUNICATION

Cove Power Modules

| | MODEL | DESCRIPTION | LIST | |
|--|---------------------|---|------|--|
| | | Cove, Clamp Mounted | | |
| | COVC2P2U-B | Cove, 2 power, 2 USB, Black | 419 | |
| | COVC2P2U-S | Cove, 2 power, 2 USB, Silver Pearl | 419 | |
| | COVC2P2U-W | Cove, 2 power, 2 USB, Gloss White | 419 | |
| | | Clamp mount method works well for desks, benches, tables and casegoods. Cord is 108" long. USB is for charging only. | | |
| | | Cove, Screw Mounted | | |
| | COVS2P2U-B | Cove, 2 power, 2 USB, Black | 419 | |
| | COVS2P2U-S | Cove, 2 power, 2 USB, Silver Pearl | 419 | |
| | COVS2P2U-W | Cove, 2 power, 2 USB, Gloss White | 419 | |
| | | Screw mount method is best suited to installations where the back of the unit has limited or no access. Cord is 108" long. USB is for charging only. | | |
| | | Cove, Clamp Mounted, 1 Convenience Outlet | | |
| | COVC2PC-B | Cove, 2 power, 1 Convenience Outlet, Black | 303 | |
| | COVC2PC-S | Cove, 2 power, 1 Convenience Outlet, Silver Pearl | 303 | |
| | COVC2PC-W | Cove, 2 power, 1 Convenience Outlet, Gloss White | 303 | |
| | | Clamp mount method works well for desks, benches, tables and casegoods. Cord is 108" long. | | |
| | | Cove, Clamp Mounted, 2 Convenience Outlets | | |
| | COVC2P2U2C-B | Cove, 2 power, 2 USB, 2 Convenience Outlets, Black | 535 | |
| | COVC2P2U2C-S | Cove, 2 power, 2 USB, 2 Convenience Outlets, Silver Pearl | 535 | |
| | COVC2P2U2C-W | Cove, 2 power, 2 USB, 2 Convenience Outlets, Gloss White | 535 | |
| | | Clamp mount method works well for desks, benches, tables and casegoods. Cord is 108" long. USB is for charging only. | | |



ENDZONE TABLES POWER & COMMUNICATION

Villa Power Modules, Daisylink™ Single Kit

| TABLE SIZE | MODEL | DESCRIPTION | LIST | |
|-------------|------------------|---|------|--|
| 36" L TABLE | VILLS2P2D-36B | 36" Villa, 2 power, 2 data ports, Black | 384 | |
| | VILLS2P2D-36S | 36" Villa, 2 power, 2 data ports, Silver | 384 | |
| | VILLS2P2D-36W | 36" Villa, 2 power, 2 data ports, White | 384 | |
| 42" L TABLE | VILLS2P2D-42B | 42" Villa, 2 power, 2 data ports, Black | 384 | |
| | VILLS2P2D-42S | 42" Villa, 2 power, 2 data ports, Silver | 384 | |
| | VILLS2P2D-42W | 42" Villa, 2 power, 2 data ports, White | 384 | |
| 48" L TABLE | VILLS2P2D-48B | 48" Villa, 2 power, 2 data ports, Black | 384 | |
| | VILLS2P2D-48S | 48" Villa, 2 power, 2 data ports, Silver | 384 | |
| | VILLS2P2D-48W | 48" Villa, 2 power, 2 data ports, White | 384 | |
| 60" L TABLE | VILLS2P2D-60B | 60" Villa, 2 power, 2 data ports, Black | 384 | |
| | VILLS2P2D-60S | 60" Villa, 2 power, 2 data ports, Silver | 384 | |
| | VILLS2P2D-60W | 60" Villa, 2 power, 2 data ports, White | 384 | |
| 72" L TABLE | VILLS2P2D-72B | 72" Villa, 2 power, 2 data ports, Black | 384 | |
| | VILLS2P2D-72S | 72" Villa, 2 power, 2 data ports, Silver | 384 | |
| | VILLS2P2D-72W | 72" Villa, 2 power, 2 data ports, White | 384 | |
| | | 2 Data Caps are included. RJ45 Data Jacks are not included. | | |
| 36" L TABLE | VILLS2P2U2RJ-36B | 36" Villa, 2 power, 2 USB 2.1 AMP ports, 2 RJ45 cat 6 data, Black | 638 | |
| | VILLS2P2U2RJ-36S | 36" Villa, 2 power, 2 USB 2.1 AMP ports, 2 RJ45 cat 6 data, Silver | 638 | |
| | VILLS2P2U2RJ-36W | 36" Villa, 2 power, 2 USB 2.1 AMP ports, 2 RJ45 cat 6 data, White | 638 | |
| 42" L TABLE | VILLS2P2U2RJ-42B | 42" Villa, 2 power, 2 USB 2.1 AMP ports, 2 RJ45 cat 6 data, Black | 638 | |
| | VILLS2P2U2RJ-42S | 42" Villa, 2 power, 2 USB 2.1 AMP ports, 2 RJ45 cat 6 data, Silver | 638 | |
| | VILLS2P2U2RJ-42W | 42" Villa, 2 power, 2 USB 2.1 AMP ports, 2 RJ45 cat 6 data, White | 638 | |
| 48" L TABLE | VILLS2P2U2RJ-48B | 48" Villa, 2 power, 2 USB 2.1 AMP ports, 2 RJ45 cat 6 data, Black | 638 | |
| | VILLS2P2U2RJ-48S | 48" Villa, 2 power, 2 USB 2.1 AMP ports, 2 RJ45 cat 6 data, Silver | 638 | |
| | VILLS2P2U2RJ-48W | 48" Villa, 2 power, 2 USB 2.1 AMP ports, 2 RJ45 cat 6 data, White | 638 | |
| 60" L TABLE | VILLS2P2U2RJ-60B | 60" Villa, 2 power, 2 USB 2.1 AMP ports, 2 RJ45 cat 6 data, Black | 638 | |
| | VILLS2P2U2RJ-60S | 60" Villa, 2 power, 2 USB 2.1 AMP ports, 2 RJ45 cat 6 data, Silver | 638 | |
| | VILLS2P2U2RJ-60W | 60" Villa, 2 power, 2 USB 2.1 AMP ports, 2 RJ45 cat 6 data, White | 638 | |
| 72" L TABLE | VILLS2P2U2RJ-72B | 72" Villa, 2 power, 2 USB 2.1 AMP ports, 2 RJ45 cat 6 data, Black | 638 | |
| | VILLS2P2U2RJ-72S | 72" Villa, 2 power, 2 USB 2.1 AMP ports, 2 RJ45 cat 6 data, Silver | 638 | |
| | VILLS2P2U2RJ-72W | 72" Villa, 2 power, 2 USB 2.1 AMP ports, 2 RJ45 cat 6 data, White | 638 | |
| | VRJ45 | Single RJ45 Cat6, Black | 58 | |
| | VHDMI-KEY | HDMI F/F Keystone Jack, Black | 61 | |

SINGLE KIT INCLUDES:

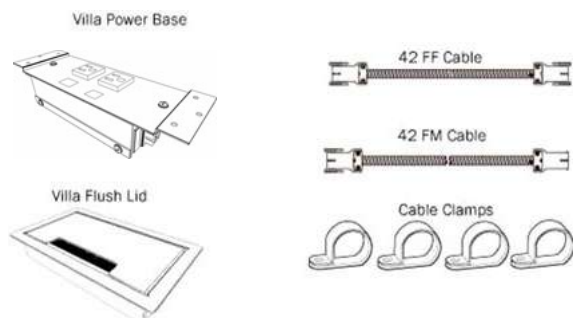

ENDZONE TABLES POWER & COMMUNICATION

Villa Power Modules, Daisylink™ Double Kit

| TABLE SIZE | MODEL | DESCRIPTION | LIST | |
|-------------|------------------|---|------|--|
| 60" L TABLE | VILLD2P2D-60B | 60" Villa, 2 power, 2 data ports, Black | 724 | |
| | VILLD2P2D-60S | 60" Villa, 2 power, 2 data ports, Silver | 724 | |
| | VILLD2P2D-60W | 60" Villa, 2 power, 2 data ports, White | 724 | |
| 72" L TABLE | VILLD2P2D-72B | 72" Villa, 2 power, 2 data ports, Black | 724 | |
| | VILLD2P2D-72S | 72" Villa, 2 power, 2 data ports, Silver | 724 | |
| | VILLD2P2D-72W | 72" Villa, 2 power, 2 data ports, White | 724 | |
| 84" L TABLE | VILLD2P2D-84B | 84" Villa, 2 power, 2 data ports, Black | 724 | |
| | VILLD2P2D-84S | 84" Villa, 2 power, 2 data ports, Silver | 724 | |
| | VILLD2P2D-84W | 84" Villa, 2 power, 2 data ports, White | 724 | |
| 96" L TABLE | VILLD2P2D-96B | 96" Villa, 2 power, 2 data ports, Black | 724 | |
| | VILLD2P2D-96S | 96" Villa, 2 power, 2 data ports, Silver | 724 | |
| | VILLD2P2D-96W | 96" Villa, 2 power, 2 data ports, White | 724 | |
| | | 2 Data Caps are included. RJ45 Data Jacks are not included. | | |
| 60" L TABLE | VILLD2P2U2RJ-60B | 60" Villa, 2 power, 2 USB 2.1 AMP ports, 2 RJ45 cat 6 data, Black | 1229 | |
| | VILLD2P2U2RJ-60S | 60" Villa, 2 power, 2 USB 2.1 AMP ports, 2 RJ45 cat 6 data, Silver | 1229 | |
| | VILLD2P2U2RJ-60W | 60" Villa, 2 power, 2 USB 2.1 AMP ports, 2 RJ45 cat 6 data, White | 1229 | |
| 72" L TABLE | VILLD2P2U2RJ-72B | 72" Villa, 2 power, 2 USB 2.1 AMP ports, 2 RJ45 cat 6 data, Black | 1229 | |
| | VILLD2P2U2RJ-72S | 72" Villa, 2 power, 2 USB 2.1 AMP ports, 2 RJ45 cat 6 data, Silver | 1229 | |
| | VILLD2P2U2RJ-72W | 72" Villa, 2 power, 2 USB 2.1 AMP ports, 2 RJ45 cat 6 data, White | 1229 | |
| 84" L TABLE | VILLD2P2U2RJ-84B | 84" Villa, 2 power, 2 USB 2.1 AMP ports, 2 RJ45 cat 6 data, Black | 1229 | |
| | VILLD2P2U2RJ-84S | 84" Villa, 2 power, 2 USB 2.1 AMP ports, 2 RJ45 cat 6 data, Silver | 1229 | |
| | VILLD2P2U2RJ-84W | 84" Villa, 2 power, 2 USB 2.1 AMP ports, 2 RJ45 cat 6 data, White | 1229 | |
| 96" L TABLE | VILLD2P2U2RJ-96B | 96" Villa, 2 power, 2 USB 2.1 AMP ports, 2 RJ45 cat 6 data, Black | 1229 | |
| | VILLD2P2U2RJ-96S | 96" Villa, 2 power, 2 USB 2.1 AMP ports, 2 RJ45 cat 6 data, Silver | 1229 | |
| | VILLD2P2U2RJ-96W | 96" Villa, 2 power, 2 USB 2.1 AMP ports, 2 RJ45 cat 6 data, White | 1229 | |
| | VRJ45 | Single RJ45 Cat6, Black | 58 | |
| | VHDMI-KEY | HDMI F/F Keystone Jack, Black | 61 | |

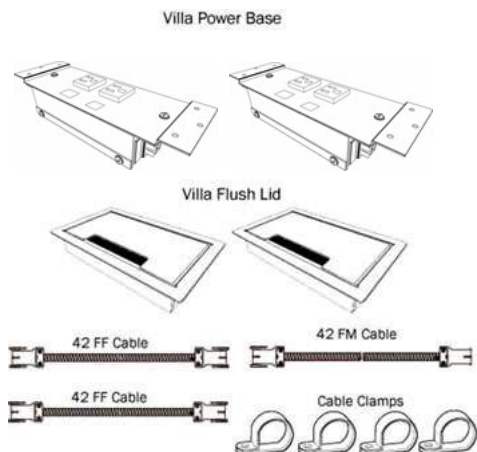

Specify double kit when two Villas are in one single table

DOUBLE KIT INCLUDES







ENDZONE TABLES POWER & COMMUNICATION

Villa Power Modules, Corded

| | MODEL | DESCRIPTION | LIST | |
|--|----------------------|--|------|---|
| | VILLCDKO-36B | Corded Villa, 2 power, 2 data ports, 36" cord, Black | 295 |  |
| | VILLCDKO-36S | Corded Villa, 2 power, 2 data ports, 36" cord, Silver | 295 | |
| | VILLCDKO-72B | Corded Villa, 2 power, 2 data ports, 72" cord, Black | 295 | |
| | VILLCDKO-72S | Corded Villa, 2 power, 2 data ports, 72" cord, Silver | 295 | |
| | VILLCDKO-108B | Corded Villa, 2 power, 2 data ports, 108" cord, Black | 295 | |
| | VILLCDKO-108S | Corded Villa, 2 power, 2 data ports, 108" cord, Silver | 295 | |
| | VILLCUDKO-72B | Corded Villa, 2 power, 2 USB 2.1 AMP charging ports, 2 data ports, 72" cord, Black | 442 |  |
| | VILLCUDKO-72S | Corded Villa, 2 power, 2 USB 2.1 AMP charging ports, 2 data ports, 72" cord, Silver 2 Data Caps are included. RJ45 Data Jacks are not included. | 442 | |
| | VRJ45 | Single RJ45 Cat6, Black | 58 |  |
| | VHDMI-KEY | HDMI F/F Keystone Jack, Black | 61 | |

Villa Power Modules, Options

| | MODEL | DESCRIPTION | LIST | |
|--|----------------------|---|------|---|
| | VILLPOWERFEED | Multi-Circuit Hardwired Power Infeed UL Listed & CSA Certified | 213 |  |
| | VILLQDINSERT | Insert for floor box and wall outlet applications. Fits standard Decora® opening. UL Listed & CSA Certified | 94 |  |
| | VILLFEEDPLUG | Single Circuit Power Infeed with 72" Molded Plug Required for non-sequenced power applications. UL Listed | 205 |  |
| | VILL42FFL-72 | Female/Female Interconnecting Cable UL Listed & CSA Certified | 134 |  |
| | VILLDAISYT | Daisy-T Power Manager | 140 |  |

ENDZONE TABLES POWER & COMMUNICATION

Power Access Door

| TOP LENGTH | MODEL | DESCRIPTION | LIST | |
|-------------------------|--------|--|---------------------------|--|
| <i>Table Top Length</i> | | <i># of doors</i> <i>Length of Door(s)</i> | <i>Upcharge per table</i> | |
| 72" | AD40 | 1 40" | 567 | |
| 84" | AD52 | 1 52" | 713 | |
| 96" | AD76 | 1 76" | 756 | |
| 108" | - | - - | | |
| 120" | - | - - | | |
| 144" | AD40-2 | 2 40" | 1134 | |
| 168" | AD52-2 | 2 52" | 1426 | |
| 192" | - | - - | | |
| 216" | - | - - | | |

Number of Duplexes and Data & Communication Cutouts

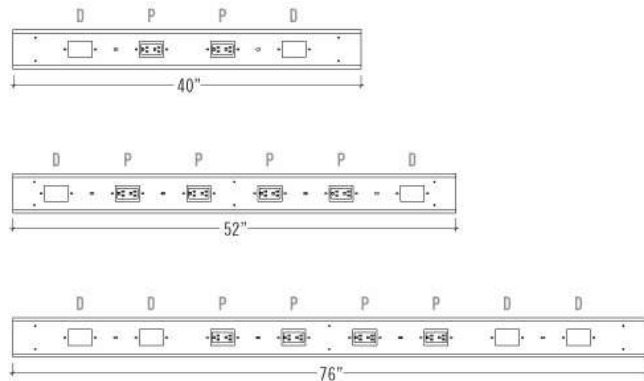



EndZone Power Access Door comes standard with 2 or 4 Duplexes (depending on size of table) and 2 communication cutouts. Specify data (below) separately.

Units in data plates must equal 3. Plates can be made up of items that equal 1 unit each for a total of 3 units or a combination of items that total 3 units.

- 

OPTION 11 - \$ 138 List
15 Pin VGA
(1 Unit)
Front: 15 Pin Female
Back: 15 Pin Female
- 

OPTION 14 - No Charge
Blank
(1 Unit)
- 

OPTION 22 - \$ 243 List
USB 2.0 Performance
(1 Unit)
Front: Type A & A (F/F)
Back: Type A & A (F/F)
- 

OPTION 23 - \$201 List
HDMI-A/V Connector
(1 Unit)
Front: Female
Back: Female
- 

OPTION 28 - \$ 79 List
RJ 45 (cat. 6) X 2
(1 Unit)
- 

OPTION 29 - \$ 43 List
RJ 45 (cat. 6) X 1
(1 Unit)

FACTORY TABLE



PRODUCT CODE

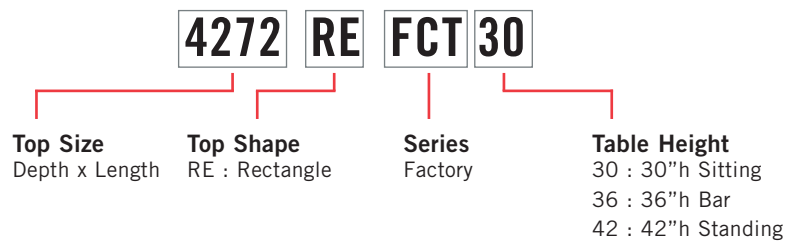

FINISHES

LAMINATE



Select from 15 standard laminates or choose any standard Wilsonart, Nevamar, Formica, Arborite and Pionite matte finish laminates at no upcharge

BASE



Select from one of our 76 standard Spectone colors

EDGE



See Spectone Card or specfurniture.com/materials/finishes for a complete list of finish options and colors.

HOW TO ORDER

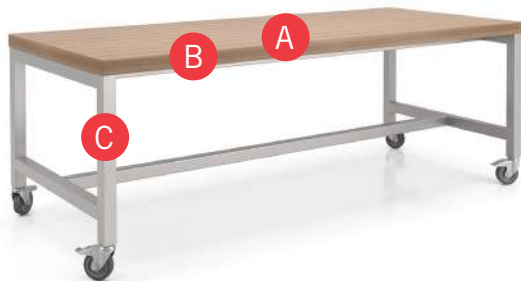

Specify Top Size (Width x Length)

- A** Specify Top Finish
Manufacturer, Laminate Name, Laminate Code
- B** Specify Edge Type and Finish
2mm Bio/2mm PVC Woodgrain/Self Edge
- C** Specify Base Style and Finish

Optional: Casters, Footrest, Power and Data Modules, 1-3/4" Solid Wood Top, Vertical Wire Manager

| Top Size | Top Finish | Edge Type and Finish | Base Style and Finish | Option specified |
|----------|---------------------------------|--|-----------------------|------------------|
| 36 x 84 | Laminate, Arborite, Brown Sugar | Self Edge, Laminate, Arborite, Brown Sugar | FCT30, Silver | Casters |



FACTORY TABLE GENERAL PURPOSE

| MODEL | BASES | TOP SPECIFICATIONS | | OPTIONS | | LBS |
|-----------------|-------|--------------------|-------------------------------|----------------------|----------|-----|
| | | Code | For Laminate Top SE 2MM | Casters ¹ | Footrest | |
| <i>30" high</i> | | | | | | |
| 36 X 72RE | FCT30 | | 3343 | 404 | | 156 |
| 36 X 84RE | FCT30 | | 3589 | 404 | | 174 |
| 36 X 96RE | FCT30 | | 3835 | 404 | | 192 |
| 42 X 72RE | FCT30 | | 3589 | 404 | | 172 |
| 42 X 84RE | FCT30 | | 3876 | 404 | | 191 |
| 42 X 96RE | FCT30 | | 4162 | 404 | | 211 |
| <i>36" high</i> | | | | | | |
| 36 X 72RE | FCT36 | | 3478 | 404 | 581 | 160 |
| 36 X 84RE | FCT36 | | 3724 | 404 | 581 | 178 |
| 36 X 96RE | FCT36 | | 3970 | 404 | 581 | 196 |
| 42 X 72RE | FCT36 | | 3724 | 404 | 581 | 175 |
| 42 X 84RE | FCT36 | | 4011 | 404 | 581 | 195 |
| 42 X 96RE | FCT36 | | 4297 | 404 | 581 | 215 |
| <i>42" high</i> | | | | | | |
| 36 X 72RE | FCT42 | | 3478 | 404 | 581 | 164 |
| 36 X 84RE | FCT42 | | 3724 | 404 | 581 | 182 |
| 36 X 96RE | FCT42 | | 3970 | 404 | 581 | 200 |
| 42 X 72RE | FCT42 | | 3724 | 404 | 581 | 179 |
| 42 X 84RE | FCT42 | | 4011 | 404 | 581 | 199 |
| 42 X 96RE | FCT42 | | 4297 | 404 | 581 | 219 |

¹ For four (4) casters



FCT30



FCT42



FCT42
WITH OPTIONAL FOOTREST



WIRE MANAGER

STANDARD FEATURES

- 2" built up edge
- 2" square leg
- Select from 15 standard laminates or choose any standard Wilsonart, Nevamar, Formica, Arborite and Pionite matte finish laminates at no upcharge. For other laminate please contact the factory for pricing.
- Standard with two bases and one bottom stretcher.
- Standard with leveling glides.
- Bases available in any Spectone color.
- Standard 30", 36", or 42" table height, please specify.
- Ships Knocked Down.

OPTIONS

- 4 casters standard in Grey
- Footrest on both sides
- For applicable Power & Data modules, please see Table Accessories Price List.
- Vertical Wire Manager magnetically attaches to any base, add \$156 List each
- For veneer finishes or 1-3/4" solid wood top, please contact the factory.
- Chroming is available, please contact the factory.

HOW TO ORDER

1. Select Model
2. Select Base
3. Select Edge Style
4. Select Options
5. Select Top Finish
6. Select Edge Finish
7. Select Base Finish

Example: 3684RE - FCT30 - 2MM



FITT TABLES



PRODUCT CODE

3030 D FX4

Size
Width x Length
or diameter

Top Shape
D : Round
SQ : Square

Series
Fitt

OPTIONS

CASTERS



CAFE HEIGHT



FINISHES

LAMINATE



Select from 15 standard laminates or choose any standard Wilsonart, Nevamar, Formica, Arborite and Pionite matte finish laminates at no upcharge

BASE



Select from one of our 76 standard Spectone colors

EDGE



Check out our website for a complete list of edge profiles.

See Spectone Card or specfurniture.com/materials/finishes for a complete list of finish options and colors.

FITT TABLES

BACK TO CONTENTS

HOW TO ORDER



Specify Top Size (Width x Length) and Shape

- A** Specify Top Finish
Manufacturer, Laminate Name, Laminate Code
- B** Specify Edge Type and Finish
PVC Flat/2mm Bio/2mm PVC Woodgrain/Self Edge
- C** Specify Base Style and Finish

Optional: Hard Casters, Soft Casters, Grommets, Power and Data Modules

Restrictions may apply. See price list tables below for more information.

| Top Size and Shape | Top Finish | Edge Type and Finish | Base Style and Finish |
|--------------------|---------------------------------|--|-----------------------|
| 30D, Round | Laminate, Arborite, Brown Sugar | Self Edge, Laminate, Arborite, Brown Sugar | FX4, Silver |





FITT TABLES

GENERAL PURPOSE



| MODEL | BASES | | TOP SPECIFICATIONS | | OPTIONS | | LBS |
|---------------|-----------------|-------------|-------------------------|--|---------|------|-----|
| | <i>Code</i> | <i>Qty.</i> | <i>For Laminate Top</i> | | | | |
| | | | PVF | | CASTERS | | |
| | | | 2MM | | HARD | SOFT | |
| | | | SE | | (HC) | (SC) | |
| <i>Round</i> | | | | | | | |
| 30D | FX4 | 1 | 602 | | 96 | 204 | 38 |
| | FX4 CAFE HEIGHT | 1 | 673 | | | | 40 |
| 36D | FX4 | 1 | 686 | | 96 | 204 | 46 |
| | FX4 CAFE HEIGHT | 1 | 757 | | | | 48 |
| 42D | FX4 | 1 | 741 | | 96 | 204 | 56 |
| | FX4 CAFE HEIGHT | 1 | 812 | | | | 58 |
| 48D | FX4 | 1 | 897 | | 96 | 204 | 85 |
| 54D | FX4 | 1 | 964 | | 96 | 204 | 98 |
| 60D | FX4 | 1 | 1038 | | 96 | 204 | 113 |
| <i>Square</i> | | | | | | | |
| 30 x 30SQ | FX4 | 1 | 636 | | 96 | 204 | 38 |
| | FX4 CAFE HEIGHT | 1 | 707 | | | | 40 |
| 36 x 36SQ | FX4 | 1 | 692 | | 96 | 204 | 46 |
| | FX4 CAFE HEIGHT | 1 | 763 | | | | 48 |
| 42 x 42SQ | FX4 | 1 | 842 | | 96 | 204 | 73 |
| 48 x 48SQ | FX4 | 1 | 902 | | 96 | 204 | 85 |
| 54 x 54SQ | FX4 | 1 | 971 | | 96 | 204 | 98 |
| 60 x 60SQ | FX4 | 1 | 1047 | | 96 | 204 | 113 |



42D-FX4



30D-FX4 CAFE HEIGHT

STANDARD FEATURES

- Fitt is a lightweight multiuse table designed for light use contract applications.
- Tops are constructed from 0.75" particle board core with laminate surface and backer.
- Select from 15 standard laminates or choose any standard Wilsonart, Nevamar, Formica, Arborite and Pionite matte finish laminates at no upcharge. For other laminate please contact the factory for pricing.
- Standard table height is 29". Café height is 39".
- Base available in any Spectone color.
- All bases are standard with floor leveling glides.
- Base span increases with size of top.
- Casters are not self-leveling.

OPTIONS

- For applicable Power & Data modules, please see Table Accessories Price List.

HOW TO ORDER

- Select Model
- Select Base
- Select Edge Style
- Select Options
- Select Top Finish
- Select Edge Finish
- Select Base Finish

Example: 30D - FX4 - PVF -



HALF ROUND TABLES



PRODUCT CODE

2430 RE T HR

Top Size
Width x Length

Top Shape
 D : Round C90 : Radius (*connector*)
 SQ : Square CRC90 : Crescent
 RE : Rectangle BT : Boatshape
 RT : Racetrack BTA : Boatshape Arc
 B : Bullet
 H : Halfmoon
 TP : Trapezoid

Base
 X : X-Base
 X4 : 4 Column X-Base
 T : T-Base
 T2 : Double Column T-Base

Series
Half Round

OPTIONS

FLIP TOP



CASTERS



FOLDING



FINISHES

LAMINATE



Select from 15 standard laminates or choose any standard Wilsonart, Nevamar, Formica, Arborite and Pionite matte finish laminates at no upcharge

VENEER

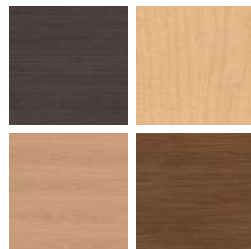

Select from one of our 9 standard wood stains or stain-to-match at no upcharge

BASE



Select from one of our 76 standard Spectone colors

EDGE



See Spectone Card or specfurniture.com/materials/finishes for a complete list of finish options and colors.



HALF ROUND TABLES

HOW TO ORDER

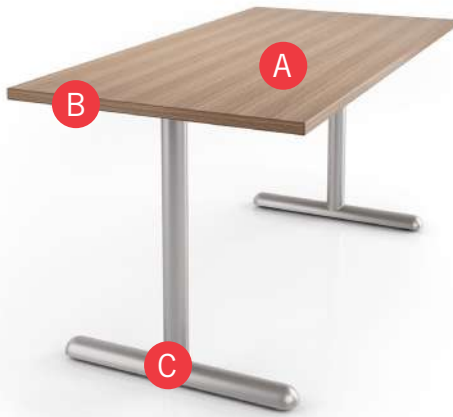

Specify Top Size (Width x Length) and Shape

- A** Specify Top Type and Finish
For Laminate Top: Manufacturer, Laminate Name, Laminate Code
For Veneer Top: Wood Stain
- B** Specify Edge Type, (for hardwood: Style), and Finish
PVC/2mm/Self Edge/Exposed Baltic Birch Plywood/Hardwood
- C** Specify Base Style and Finish

Optional: Flip Top, Fold, Hard Casters, Soft Casters, Wheelbarrow Wheels, Grommets, Seam Connectors, Modesty Panels, Adjustable Height, Power and Data Modules, Custom Solutions

Restrictions may apply. See price list tables below for more information.

| Top Size and Shape | Top Type and Finish | Edge Type and Finish | Base Style and Finish |
|--------------------|---------------------------------|--|-----------------------|
| 36 x 48, Rectangle | Laminate, Arborite, Brown Sugar | Hardwood, HF, Custom Brown Sugar Stain | THR, Silver |



EDGE PROFILES

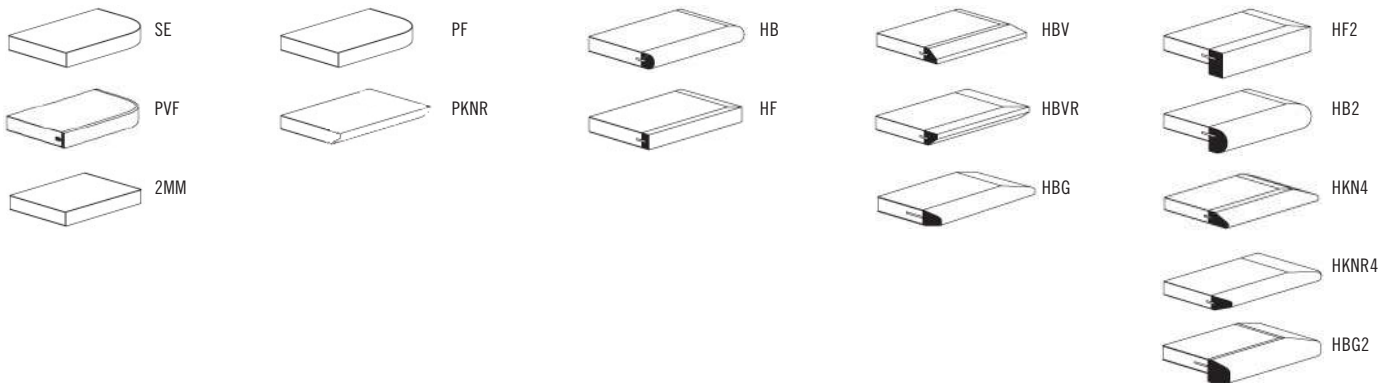



HALF ROUND TABLES GENERAL PURPOSE



| MODEL | BASES | | TOP SPECIFICATIONS | | | | | | OPTIONS | | | LBS |
|---------------|-------|------|--------------------|--|--------------------|-------------------------------------|--------------------------------|-------------------------------------|---------------|---------|--------------|--------------|
| | Code | Qty. | For Laminate Top | | | For Veneer Top | | | FLIP TOP (FT) | CASTERS | | |
| | | | SE PVF 2MM | HF HB PKNR ¹ PF ¹ | HBV HBVR HBG | HF2 HB2 HKN4 HKNR4 HBG2 | HF HB HBV HBVR HBG | HF2 HB2 HKN4 HKNR4 HBG2 | | | HARD (HC) | SOFT (SC) |
| <i>Round</i> | | | | | | | | | | | | |
| 24D | XHR | 1 | 681 | 1041 | 1078 | 1187 | 1246 | 1358 | 154 | 96 | 204 | 47 |
| 30D | XHR | 1 | 785 | 1140 | 1187 | 1405 | 1350 | 1514 | 154 | 96 | 204 | 57 |
| 36D | XHR | 1 | 884 | 1397 | 1488 | 1666 | 1720 | 1949 | 154 | 96 | 204 | 68 |
| 42D | XHR | 1 | 1169 | 1745 | 1869 | 2134 | 2160 | 2473 | 154 | 96 | 204 | 82 |
| | X4HR | 1 | 1453 | 2029 | 2153 | 2418 | 2444 | 2757 | | | | |
| 48D | XHR | 1 | 1192 | 1965 | 2100 | 2232 | 2706 | 3108 | 154 | 96 | 204 | 98 |
| | X4HR | 1 | 1476 | 2249 | 2384 | 2516 | 2990 | 3392 | | | | |
| 54D | X4HR | 1 | 1766 | 2906 | 3116 | 3316 | 3552 | 4068 | | | | 128 |
| 60D | X4HR | 1 | 1814 | 3108 | 3332 | 3501 | 4187 | 4828 | | | | 147 |
| <i>Square</i> | | | | | | | | | | | | |
| 24 x 24SQ | XHR | 1 | 712 | 907 | 944 | 1012 | 1062 | 1229 | 154 | 96 | 204 | 47 |
| 30 x 30SQ | XHR | 1 | 819 | 961 | 1012 | 1192 | 1126 | 1358 | 154 | 96 | 204 | 57 |
| 36 x 36SQ | XHR | 1 | 902 | 1125 | 1187 | 1397 | 1405 | 1605 | 154 | 96 | 204 | 68 |
| 42 x 42SQ | XHR | 1 | 1336 | 1659 | 1758 | 1858 | 1927 | 2200 | 310 | | | 82 |
| | X4HR | 1 | 1467 | 1790 | 1889 | 1989 | 2058 | 2331 | | | | |
| 48 x 48SQ | X4HR | 1 | 1621 | 1904 | 2009 | 2056 | 2434 | 2787 | | 96 | 204 | 110 |
| 54 x 54SQ | X4HR | 1 | 1769 | 2393 | 2557 | 2747 | 2851 | 3308 | | | | 128 |
| 60 x 60SQ | X4HR | 1 | 1799 | 2499 | 2674 | 2865 | 3330 | 3883 | | | | 147 |

¹ Exposed Baltic Birch plywood edge (PKNR, PF) can only be specified on square tops up to 47-1/2" x 95-1/2". Clear finish only.



STANDARD FEATURES

- Select from 15 standard laminates or choose any standard Wilsonart, Nevamar, Formica, Arborite and Pionite matte finish laminates at no upcharge. For other laminate please contact the factory for pricing.
- 9 standard veneer and hardwood edge stains. Stain-to-match available at no upcharge.
- Bases available in any Spectone color.
- Standard table height 29".
- All bases are standard with floor leveling glides.

OPTIONS

- Custom heights available.
- For applicable Power & Data modules, please see Table Accessories Price List.

HOW TO ORDER

1. Select Model
2. Select Base
3. Select Edge Style
4. Select Options
5. Select Top Finish
6. Select Edge Finish
7. Select Base Finish

Example: 24D - XHR - PVF -





HALF ROUND TABLES GENERAL PURPOSE

| MODEL | BASES | | TOP SPECIFICATIONS | | | | | | OPTIONS | | | | LBS | |
|------------------|-------|------|--------------------|--|--------------------|-------------------------------------|--------------------------------|-------------------------------------|---------------|------------|---------|-----|-----------|-------------|
| | Code | Qty. | For Laminate Top | | | For Veneer Top | | | FLIP TOP (FT) | FOLD* (FL) | CASTERS | | | WHEELS (WB) |
| | | | SE PVF 2MM | HF HB PKNR ¹ PF ¹ | HBV HBVR HBG | HF2 HB2 HKN4 HKNR4 HBG2 | HF HB HBV HBVR HBG | HF2 HB2 HKN4 HKNR4 HBG2 | | | | | HARD (HC) | |
| <i>Rectangle</i> | | | | | | | | | | | | | | |
| 24 x 30RE | XHR | 1 | 808 | 940 | 989 | 1057 | 1110 | 1241 | 154 | | | | | 56 |
| | THR | 2 | 922 | 1054 | 1103 | 1171 | 1224 | 1355 | 310 | | 96 | 204 | 95 | 58 |
| 24 x 36RE | XHR | 1 | 808 | 940 | 989 | 1057 | 1110 | 1241 | 154 | | | | | 56 |
| | THR | 2 | 922 | 1054 | 1103 | 1171 | 1224 | 1355 | 310 | | 96 | 204 | 95 | 58 |
| 24 x 42RE | THR | 2 | 987 | 1202 | 1258 | 1359 | 1420 | 1601 | 310 | | 96 | 204 | 95 | 66 |
| 24 x 48RE | THR | 2 | 987 | 1202 | 1258 | 1359 | 1420 | 1601 | 310 | | 96 | 204 | 95 | 66 |
| 24 x 54RE | THR | 2 | 1048 | 1361 | 1431 | 1547 | 1634 | 1856 | 310 | | 96 | 204 | 95 | 74 |
| 24 x 60RE | THR | 2 | 1048 | 1361 | 1431 | 1547 | 1634 | 1856 | 310 | 297 | 96 | 204 | 95 | 74 |
| 24 x 66RE | THR | 2 | 1196 | 1573 | 1659 | 1801 | 1892 | 2164 | 310 | 297 | 96 | 204 | 95 | 83 |
| 24 x 72RE | THR | 2 | 1196 | 1573 | 1659 | 1801 | 1892 | 2164 | 310 | 297 | 96 | 204 | 95 | 83 |
| 30 x 36RE | XHR | 1 | 902 | 1057 | 1111 | 1200 | 1262 | 1420 | 154 | | | | | 62 |
| | THR | 2 | 1016 | 1171 | 1225 | 1314 | 1376 | 1534 | 310 | | 96 | 204 | 95 | 64 |
| 30 x 42RE | XHR | 1 | 924 | 1218 | 1285 | 1401 | 1487 | 1707 | 154 | | | | | 72 |
| | THR | 2 | 1038 | 1332 | 1399 | 1515 | 1601 | 1821 | 310 | | 96 | 204 | 95 | 74 |
| 30 x 48RE | XHR | 1 | 924 | 1218 | 1285 | 1401 | 1487 | 1707 | 154 | | | | | 72 |
| | THR | 2 | 1038 | 1332 | 1399 | 1515 | 1601 | 1821 | 310 | | 96 | 204 | 95 | 74 |
| 30 x 54RE | THR | 2 | 1099 | 1499 | 1586 | 1752 | 1850 | 2126 | 310 | | 96 | 204 | 95 | 85 |
| 30 x 60RE | THR | 2 | 1099 | 1499 | 1586 | 1752 | 1850 | 2126 | 310 | 297 | 96 | 204 | 95 | 85 |
| 30 x 66RE | THR | 2 | 1275 | 1600 | 1706 | 1873 | 1969 | 2274 | 310 | 297 | 96 | 204 | 95 | 95 |
| 30 x 72RE | THR | 2 | 1333 | 1756 | 1863 | 2079 | 2192 | 2528 | 310 | 297 | 96 | 204 | 95 | 95 |

*Folding tables available with PVC Flat (PVF) edge only.

¹ Exposed Baltic Birch plywood edge (PKNR, PF) can only be specified on square tops up to 47-1/2" x 95-1/2". Clear finish only.



STANDARD FEATURES

- Select from 15 standard laminates or choose any standard Wilsonart, Nevamar, Formica, Arborite and Pionite matte finish laminates at no upcharge. For other laminate please contact the factory for pricing.
- 9 standard veneer and hardwood edge stains. Stain-to-match available at no upcharge.
- Bases available in any Spectone color.
- Standard table height 29".
- All bases are standard with floor leveling glides.

OPTIONS

- Custom heights available.
- For applicable Power & Data modules, please see Table Accessories Price List.

HOW TO ORDER

1. Select Model
2. Select Base
3. Select Edge Style
4. Select Options
5. Select Top Finish
6. Select Edge Finish
7. Select Base Finish

Example: 2430RE - XHR - PVF -
 MODEL | BASE | EDGE | OPTIONS



HALF ROUND TABLES GENERAL PURPOSE

| MODEL | BASES | | TOP SPECIFICATIONS | | | | | | OPTIONS | | | | LBS | |
|------------------|-------|------|--------------------|---|--------------|-------------------------|--------------------|-------------------------|---------------|------------|-------------------|-----------|-----|-------------|
| | Code | Qty. | For Laminate Top | | | For Veneer Top | | | FLIP TOP (FT) | FOLD* (FL) | CASTERS HARD (HC) | SOFT (SC) | | WHEELS (WB) |
| | | | SE PVF 2MM | HF HB PKNR ¹ PF ¹ | HBV HBVR HBG | HF2 HB2 HKN4 HKNR4 HBG2 | HF HB HBV HBVR HBG | HF2 HB2 HKN4 HKNR4 HBG2 | | | | | | |
| <i>Rectangle</i> | | | | | | | | | | | | | | |
| 30 x 78RE | THR | 2 | 1561 | 1936 | 2063 | 2314 | 2446 | 2832 | 310 | 297 | 96 | 204 | | 106 |
| 30 x 84RE | THR | 2 | 1561 | 1936 | 2063 | 2314 | 2446 | 2832 | 310 | 297 | 96 | 204 | | 106 |
| 30 x 90RE | THR | 2 | 1583 | 2161 | 2314 | 2546 | 2702 | 3142 | | 297 | 96 | 204 | 95 | 116 |
| 30 x 96RE | THR | 2 | 1583 | 2161 | 2314 | 2546 | 2702 | 3142 | | 297 | 96 | 204 | 95 | 116 |
| 36 x 42RE | THR | 2 | 1140 | 1361 | 1445 | 1560 | 1650 | 1881 | 310 | | 96 | 204 | 95 | 83 |
| 36 x 48RE | THR | 2 | 1165 | 1477 | 1568 | 1706 | 1797 | 2068 | 310 | | 96 | 204 | 95 | 83 |
| 36 x 60RE | THR | 2 | 1264 | 1698 | 1808 | 1984 | 2095 | 2433 | 310 | 297 | 96 | 204 | 95 | 95 |
| 36 x 66RE | THR | 2 | 1354 | 1804 | 1931 | 2124 | 2246 | 2617 | 310 | 297 | 96 | 204 | 95 | 108 |
| | T2HR | 2 | 1610 | 2060 | 2187 | 2380 | 2502 | 2873 | | 597 | 96 | 204 | | 134 |
| 36 x 72RE | THR | 2 | 1393 | 1863 | 1984 | 2263 | 2399 | 2800 | 310 | 297 | 96 | 204 | 95 | 108 |
| | T2HR | 2 | 1649 | 2119 | 2240 | 2519 | 2655 | 3056 | | 597 | 96 | 204 | | 134 |
| 36 x 78RE | THR | 2 | 1734 | 2237 | 2395 | 2638 | 2796 | 3269 | | 297 | 96 | 204 | 95 | 121 |
| | T2HR | 2 | 1990 | 2493 | 2651 | 2894 | 3052 | 3525 | | 597 | 96 | 204 | | 147 |
| 36 x 84RE | THR | 2 | 1734 | 2237 | 2395 | 2638 | 2796 | 3269 | | 297 | 96 | 204 | 95 | 121 |
| | T2HR | 2 | 1990 | 2493 | 2651 | 2894 | 3052 | 3525 | | 597 | 96 | 204 | | 147 |
| 36 x 90RE | THR | 2 | 1741 | 2458 | 2638 | 2921 | 3103 | 3627 | | | 96 | 204 | 95 | 133 |
| | T2HR | 2 | 1997 | 2714 | 2894 | 3177 | 3359 | 3883 | | 597 | 96 | 204 | | 159 |
| 36 x 96RE | THR | 2 | 1741 | 2458 | 2638 | 2921 | 3103 | 3627 | | | 96 | 204 | 95 | 133 |
| | T2HR | 2 | 1997 | 2714 | 2894 | 3177 | 3359 | 3883 | | 597 | 96 | 204 | | 159 |
| 42 x 78RE | T2HR | 2 | 2238 | 2670 | 2843 | 3261 | 3398 | 3946 | | 597 | 96 | 204 | | 161 |
| 42 x 84RE | T2HR | 2 | 2238 | 2670 | 2843 | 3261 | 3398 | 3946 | | 597 | 96 | 204 | | 161 |

*Folding tables available with PVC Flat (PVF) edge only.

¹ Exposed Baltic Birch plywood edge (PKNR, PF) can only be specified on square tops up to 47-1/2" x 95-1/2". Clear finish only.



2448RE-THR

STANDARD FEATURES

- Select from 15 standard laminates or choose any standard Wilsonart, Nevamar, Formica, Arborite and Pionite matte finish laminates at no upcharge. For other laminate please contact the factory for pricing.
- 9 standard veneer and hardwood edge stains. Stain-to-match available at no upcharge.
- Bases available in any Spectone color.
- Standard table height 29".
- All bases are standard with floor leveling glides.

OPTIONS

- Custom heights available.
- For applicable Power & Data modules, please see Table Accessories Price List.

HOW TO ORDER

1. Select Model
2. Select Base
3. Select Edge Style
4. Select Options
5. Select Top Finish
6. Select Edge Finish
7. Select Base Finish

Example: 3078RE - THR - PVF -





HALF ROUND TABLES

GENERAL PURPOSE

| MODEL | BASES | | TOP SPECIFICATIONS | | | | | | OPTIONS | | | | LBS |
|------------------|-------|------|--------------------|-------|--------------|--------------------|--------------------|--------------------|---------------|---------|-----------|-------------|-----------|
| | Code | Qty. | For Laminate Top | | | For Veneer Top | | | FLIP TOP (FT) | CASTERS | | WHEELS (WB) | |
| | | | SE PVF 2MM | HF HB | HBV HBVR HBG | HF2 HB2 HKNR4 HBG2 | HF HB HBV HBVR HBG | HF2 HB2 HKNR4 HBG2 | | | HARD (HC) | | SOFT (SC) |
| <i>Racetrack</i> | | | | | | | | | | | | | |
| 36 x 54RT | THR | 2 | 1321 | 1892 | 2025 | 2263 | 2361 | 2710 | 310 | 96 | 204 | 95 | 95 |
| | T2HR | 2 | 1577 | 2148 | 2281 | 2519 | 2617 | 2966 | | 96 | 204 | 95 | 121 |
| 36 x 60RT | THR | 2 | 1321 | 1892 | 2025 | 2263 | 2361 | 2710 | 310 | 96 | 204 | 95 | 95 |
| | T2HR | 2 | 1577 | 2148 | 2281 | 2519 | 2617 | 2966 | | 96 | 204 | 95 | 121 |
| 36 x 66RT | THR | 2 | 1482 | 2079 | 2223 | 2478 | 2702 | 3138 | 310 | 96 | 204 | 95 | 108 |
| | T2HR | 2 | 1738 | 2335 | 2479 | 2734 | 2958 | 3394 | | 96 | 204 | 95 | 134 |
| 36 x 72RT | THR | 2 | 1482 | 2079 | 2223 | 2478 | 2702 | 3138 | 310 | 96 | 204 | 95 | 108 |
| | T2HR | 2 | 1738 | 2335 | 2479 | 2734 | 2958 | 3394 | | 96 | 204 | 95 | 134 |
| 36 x 78RT | THR | 2 | 1752 | 2510 | 2687 | 3072 | 3153 | 3661 | | 96 | 204 | 95 | 121 |
| | T2HR | 2 | 2008 | 2766 | 2943 | 3328 | 3409 | 3917 | | 96 | 204 | 95 | 147 |
| 36 x 84RT | THR | 2 | 1752 | 2510 | 2687 | 3072 | 3153 | 3661 | | 96 | 204 | 95 | 121 |
| | T2HR | 2 | 2008 | 2766 | 2943 | 3328 | 3409 | 3917 | | 96 | 204 | 95 | 147 |
| 36 x 90RT | THR | 2 | 1756 | 2767 | 2978 | 3409 | 3510 | 4089 | | 96 | 204 | 95 | 133 |
| | T2HR | 2 | 2012 | 3023 | 3234 | 3665 | 3766 | 4345 | | 96 | 204 | 95 | 159 |
| 36 x 96RT | THR | 2 | 1756 | 2767 | 2978 | 3409 | 3510 | 4089 | | 96 | 204 | 95 | 133 |
| | T2HR | 2 | 2012 | 3023 | 3234 | 3665 | 3766 | 4345 | | 96 | 204 | 95 | 159 |
| 42 x 78RT | T2HR | 2 | 2253 | 2970 | 3187 | 3623 | 3728 | 4312 | | 96 | 204 | 95 | 176 |
| 42 x 84RT | T2HR | 2 | 2253 | 2970 | 3187 | 3623 | 3728 | 4312 | | 96 | 204 | 95 | 176 |
| 48 x 78RT | T2HR | 2 | 2256 | 3278 | 3524 | 3910 | 4151 | 4815 | | 96 | 204 | 95 | 176 |
| 48 x 84RT | T2HR | 2 | 2256 | 3278 | 3524 | 3910 | 4151 | 4815 | | 96 | 204 | 95 | 176 |



2448RE-THR

STANDARD FEATURES

- Select from 15 standard laminates or choose any standard Wilsonart, Nevamar, Formica, Arborite and Pionite matte finish laminates at no upcharge. For other laminate please contact the factory for pricing.
- 9 standard veneer and hardwood edge stains. Stain-to-match available at no upcharge.
- Bases available in any Spectone color.
- Standard table height 29".
- All bases are standard with floor leveling glides.

OPTIONS

- Custom heights available.
- For applicable Power & Data modules, please see Table Accessories Price List.

HOW TO ORDER

1. Select Model
2. Select Base
3. Select Edge Style
4. Select Options
5. Select Top Finish
6. Select Edge Finish
7. Select Base Finish

Example: 3654RT - THR - PVF -





BACK TO CONTENTS

HALF ROUND TABLES GENERAL PURPOSE



| MODEL | BASES | | TOP SPECIFICATIONS | | | | | | OPTIONS | | | LBS | |
|---------------------------|---------------|------|--------------------|-------|--------------|--------------------|--------------------|--------------------|---------------|---------|-----------|-----------|-------------|
| | Code | Qty. | For Laminate Top | | | For Veneer Top | | | FLIP TOP (FT) | CASTERS | | | WHEELS (WB) |
| | | | SE PVF 2MM | HF HB | HBV HBVR HBG | HF2 HB2 HKNR4 HBG2 | HF HB HBV HBVR HBG | HF2 HB2 HKNR4 HBG2 | | | HARD (HC) | SOFT (SC) | |
| <i>Bullet</i> | | | | | | | | | | | | | |
| 30 x 54B | THR | 2 | 1220 | 1789 | 1908 | 2116 | 2178 | 2522 | | 96 | 204 | 95 | 85 |
| 30 x 60B | THR | 2 | 1220 | 1789 | 1908 | 2116 | 2178 | 2522 | | 96 | 204 | 95 | 85 |
| 36 x 54B | THR | 2 | 1343 | 2300 | 2469 | 2774 | 2816 | 3249 | 310 | 96 | 204 | 95 | 95 |
| 36 x 60B | THR | 2 | 1343 | 2300 | 2469 | 2774 | 2816 | 3249 | 310 | 96 | 204 | 95 | 95 |
| 36 x 72B | THR | 2 | 1481 | 2539 | 2726 | 3052 | 3241 | 3785 | 310 | 96 | 204 | 95 | 108 |
| <i>Halfmoon</i> | | | | | | | | | | | | | |
| 24 x 48H | THR | 2 | 1005 | 1519 | 1648 | 1804 | 1931 | 2223 | 310 | 96 | 204 | 95 | 66 |
| 30 x 60H | THR | 2 | 1220 | 1985 | 2162 | 2338 | 2558 | 2975 | 310 | 96 | 204 | 95 | 85 |
| 36 x 72H | THR | 2 | 1481 | 2525 | 2756 | 2972 | 3329 | 3893 | 310 | 96 | 204 | 95 | 108 |
| <i>Trapezoid</i> | | | | | | | | | | | | | |
| 30 x 60TP | THR | 2 | 1220 | 1691 | 1801 | 1990 | 2045 | 2364 | 310 | 96 | 204 | 95 | 85 |
| 36 x 72TP | THR | 2 | 1481 | 2120 | 2264 | 2592 | 2674 | 3134 | 310 | 96 | 204 | 95 | 108 |
| <i>Radius (connector)</i> | | | | | | | | | | | | | |
| 24 x 24 | 24RC90 | - | 395 | 717 | 810 | 929 | 952 | 1140 | | | | | 17 |
| 30 x 30 | 30RC90 | - | 504 | 948 | 1066 | 1195 | 1263 | 1515 | | | | | 27 |
| <i>Crescent</i> | | | | | 644 | 763 | 852 | 1152 | 1476 | | | | |
| 30 x 36 | 3036CRC90-THR | 1 | 887 | 1573 | 1660 | 1728 | 1946 | 2185 | | | | | 48 |
| 36 x 42 | 3642CRC90-THR | 1 | 1250 | 1894 | 2013 | 2102 | 2402 | 2726 | | | | | 61 |



2448RE-THR

STANDARD FEATURES

- Select from 15 standard laminates or choose any standard Wilsonart, Nevamar, Formica, Arborite and Pionite matte finish laminates at no upcharge. For other laminate please contact the factory for pricing.
- 9 standard veneer and hardwood edge stains. Stain-to-match available at no upcharge.
- Bases available in any Spectone color.
- Standard table height 29".
- All bases are standard with floor leveling glides.

OPTIONS

- Custom heights available.
- For applicable Power & Data modules, please see Table Accessories Price List.

HOW TO ORDER

1. Select Model
2. Select Base
3. Select Edge Style
4. Select Options
5. Select Top Finish
6. Select Edge Finish
7. Select Base Finish

Example: 3054B - THR - PVF -





HALF ROUND TABLES BOARDROOM



| MODEL | BASES | | TOP SPECIFICATIONS | | | | | | OPTIONS | LBS |
|------------------|-------|------|--------------------|--|--------------------|-------------------------------------|--------------------------------|-------------------------------------|---------|-----|
| | Code | Qty. | For Laminate Top | | | For Veneer Top | | | | |
| | | | SE PVF 2MM | HF HB PKNR ¹ PF ¹ | HBV HBVR HBG | HF2 HB2 HKN4 HKNR4 HBG2 | HF HB HBV HBVR HBG | HF2 HB2 HKN4 HKNR4 HBG2 | | |
| <i>Rectangle</i> | | | | | | | | | | |
| 42 x 96RE | T2HR | 2 | 2291 | 3201 | 3447 | 3696 | 4064 | 4776 | | 193 |
| 48 x 96RE | T2HR | 2 | 2291 | 3201 | 3447 | 3696 | 4064 | 4776 | | 193 |
| 48 x 120RE | T2HR | 3 | 3065 | 4240 | 4518 | 5119 | 5207 | 6040 | | 255 |
| 48 x 144RE | T2HR | 3 | 3461 | 5146 | 5513 | 6084 | 5948 | 6950 | | 289 |
| 48 x 168RE | T2HR | 3 | 3965 | 5661 | 6080 | 6877 | 6693 | 7857 | | 323 |
| 60 x 120RE | T2HR | 3 | 3549 | 5306 | 5690 | 6282 | 6141 | 7186 | | 297 |
| 60 x 144RE | T2HR | 3 | 3997 | 6106 | 6565 | 7276 | 7108 | 8361 | | 339 |
| 60 x 168RE | T2HR | 3 | 4447 | 6906 | 7440 | 8272 | 8075 | 9535 | | 381 |
| <i>Racetrack</i> | | | | | | | | | | |
| 42 x 96RT | T2HR | 2 | 2311 | 3340 | 3591 | 4194 | 4620 | 5379 | | 193 |
| 48 x 96RT | T2HR | 2 | 2311 | 3340 | 3591 | 4194 | 4620 | 5379 | | 193 |
| 48 x 120RT | T2HR | 3 | 3092 | 4724 | 5051 | 5882 | 5847 | 6734 | | 255 |
| 48 x 144RT | T2HR | 3 | 3491 | 5524 | 5925 | 6955 | 6716 | 7792 | | 289 |
| 48 x 168RT | T2HR | 3 | 3997 | 6208 | 6676 | 7820 | 7598 | 8845 | | 323 |
| 60 x 120RT | T2HR | 3 | 3538 | 5578 | 5984 | 7028 | 6981 | 8094 | | 297 |
| 60 x 144RT | T2HR | 3 | 4037 | 6578 | 7081 | 8371 | 8070 | 9414 | | 339 |
| 60 x 168RT | T2HR | 3 | 4672 | 7437 | 8021 | 9447 | 9171 | 10729 | | 381 |

¹ Exposed Baltic Birch plywood edge (PKNR, PF) can only be specified on rectangle tops up to 47-1/2" x 95-1/2". Clear finish only.



4296BTA-T2HR

STANDARD FEATURES

- Select from 15 standard laminates or choose any standard Wilsonart, Nevamar, Formica, Arborite and Pionite matte finish laminates at no upcharge. For other laminate please contact the factory for pricing.
- 9 standard veneer and hardwood edge stains. Stain-to-match available at no upcharge.
- Bases available in any Spectone color.
- Standard table height 29".
- All bases are standard with floor leveling glides.

OPTIONS

- Custom heights available.
- For applicable Power & Data modules, please see Table Accessories Price List.

HOW TO ORDER

1. Select Model
2. Select Base
3. Select Edge Style
4. Select Top Finish
5. Select Edge Finish
6. Select Base Finish

Example: 4296RE - T2HR - PVF





HALF ROUND TABLES BOARDROOM



| MODEL | BASES | | TOP SPECIFICATIONS | | | | | | OPTIONS | LBS |
|------------------|-------|------|--------------------|----------|--------------------|-------------------------------------|--------------------------------|-------------------------------------|---------|-----|
| | Code | Qty. | For Laminate Top | | | For Veneer Top | | | | |
| | | | SE PVF 2MM | HF HB | HBV HBVR HBG | HF2 HB2 HKN4 HKNR4 HBG2 | HF HB HBV HBVR HBG | HF2 HB2 HKN4 HKNR4 HBG2 | | |
| <i>Boatshape</i> | | | | | | | | | | |
| 42 x 96BT | T2HR | 2 | 2311 | 4042 | 4364 | 4696 | 5167 | 5581 | | 193 |
| 48 x 96BT | T2HR | 2 | 2311 | 4042 | 4364 | 4696 | 5167 | 5581 | | 193 |
| 48 x 120BT | T2HR | 3 | 3092 | 5493 | 5892 | 6314 | 6493 | 6972 | | 255 |
| 48 x 144BT | T2HR | 3 | 3491 | 6294 | 6770 | 7276 | 7914 | 8349 | | 289 |
| 48 x 168BT | T2HR | 3 | 3997 | 7059 | 7614 | 8198 | 8496 | 9168 | | 323 |
| 60 x 120BT | T2HR | 3 | 3538 | 6537 | 7040 | 7566 | 7792 | 8386 | | 297 |
| 60 x 144BT | T2HR | 3 | 4037 | 7542 | 8137 | 8770 | 9565 | 10111 | | 339 |
| 60 x 168BT | T2HR | 3 | 4672 | 8500 | 9191 | 9922 | 10292 | 11134 | | 381 |
| <i>Boatshape</i> | | | | | | | | | | |
| <i>Arc Ends</i> | | | | | | | | | | |
| | | | | 4300 | 4992 | 5721 | 6094 | 6938 | | |
| 42 x 96BTA | T2HR | 2 | 2487 | 4593 | 4917 | 5251 | 5719 | 6133 | | 193 |
| 48 x 96BTA | T2HR | 2 | 2487 | 4593 | 4917 | 5251 | 5719 | 6133 | | 193 |
| 48 x 120BTA | T2HR | 3 | 3267 | 6047 | 6447 | 6869 | 7048 | 7523 | | 255 |
| 48 x 144BTA | T2HR | 3 | 3667 | 6845 | 7325 | 7831 | 8465 | 8903 | | 289 |
| 48 x 168BTA | T2HR | 3 | 4174 | 7614 | 8169 | 8753 | 9049 | 9724 | | 323 |
| 60 x 120BTA | T2HR | 3 | 3759 | 7232 | 7731 | 8258 | 8482 | 9077 | | 297 |
| 60 x 144BTA | T2HR | 3 | 4256 | 8231 | 8830 | 9461 | 10257 | 10800 | | 339 |
| 60 x 168BTA | T2HR | 3 | 4891 | 9191 | 9883 | 10612 | 10985 | 11829 | | 381 |



4296BTA-T2HR

STANDARD FEATURES

- Select from 15 standard laminates or choose any standard Wilsonart, Nevamar, Formica, Arborite and Pionite matte finish laminates at no upcharge. For other laminate please contact the factory for pricing.
- 9 standard veneer and hardwood edge stains. Stain-to-match available at no upcharge.
- Bases available in any Spectone color.
- Standard table height 29".
- All bases are standard with floor leveling glides.

OPTIONS

- Custom heights available.
- For applicable Power & Data modules, please see Table Accessories Price List.

HOW TO ORDER

1. Select Model
2. Select Base
3. Select Edge Style
4. Select Top Finish
5. Select Edge Finish
6. Select Base Finish

Example: 4296BT - T2HR - PVF





BEHAVIORAL HEALTH & HEAVY DUTY Specialty Tables



PRODUCT CODE

2424SQ-TR HD

Product Code

Specification

HD: Heavy Duty*

*The code for our heavy duty tables featured in the pages below is the same as a regular model of the table you are specifying. By adding the letters "HD" at the end of the product code, it lets us know the product is intended for a behavioral health environment and the features below will automatically be specified.

FEATURES

Tamper-Proof



Weighted



LOCTITE®-secured Glides



FINISHES

LAMINATE



Select from 15 standard laminates or choose any standard Wilsonart, Nevamar, Formica, Arborite and Pionite matte finish laminates at no upcharge

VENEER



Select from one of our 9 standard wood stains or stain-to-match at no upcharge

BASE



Select from one of our 76 standard Spectone colors

EDGE



Check out our website for a complete list of edge profiles.

BEHAVIORAL HEALTH & HEAVY DUTY Specialty Tables

DIGNITY

Standard Features

- Tops in laminate or veneer
- Select from 15 standard laminates or choose any standard Wilsonart, Nevamar, Formica, Arborite and Pionite matte finish laminates at no upcharge.
- Laminate tops with PVC Flat (PVF), Self Edge (SE), or hardwood (HB) edge
- 9 standard veneer and hardwood edge stains. Stain-to-match available at no upcharge.
- Tops utilize NU Green earth friendly core
- 18" height
- Non-removable steel levelling glides

Radius Corner Tables are recommended for open areas

Options

- Specify frame finish, Black (B), Sterling Grey (G) or Taupe RAL 7006 (T)
- Additional weight can be added, contact factory
- Non-standard laminates, contact Spec for pricing
- Floor mounting straps available, call Customer Service

Freestanding Lounge Tables

| Model | Laminate PVF/SE Edge | Laminate HB Edge | Veneer HB Edge | Weight | Cu.Ft. |
|-------------------|-------------------------|---------------------|-------------------|--------|--------|
| DIGN - 24 x 24 SQ | 1221 | 1418 | 1455 | 57 | 7.2 |
| DIGN - 30 x 30 SQ | 1376 | 1518 | 1569 | 74 | 13.5 |
| DIGN - 36 x 36 SQ | 1503 | 1725 | 1787 | 94 | 18 |
| DIGN - 42 x 42 SQ | 1826 | 2149 | 2247 | 116 | 24.5 |
| DIGN - 48 x 48 SQ | 2023 | 2306 | 2411 | 141 | 32 |
| DIGN - 24 DIA | 1191 | 1550 | 1588 | 45 | 7.2 |
| DIGN - 30 DIA | 1343 | 1695 | 1744 | 57 | 13.5 |
| DIGN - 36 DIA | 1483 | 1998 | 2085 | 71 | 18 |
| DIGN - 42 DIA | 1815 | 2388 | 2511 | 87 | 24.5 |
| DIGN - 48 DIA | 1877 | 2651 | 2785 | 104 | 32 |



Corner and Spacer Connecting Tables

| Model | Laminate PVF/SE | Laminate HB Edge | Veneer HB Edge | Weight | Cu.Ft. |
|--|--------------------|---------------------|-------------------|--------|--------|
| DIGNRC - 28 x 28 <i>Radius Corner Table</i> | 704 | 882 | 1091 | 31 | 2 |
| DIGNSC - 28 x 28 <i>Square Corner Table</i> | 704 | 882 | 1091 | 32 | 2 |
| DIGNTC - 45 degree <i>Corner Table</i> | 704 | 882 | 1091 | 26 | 2 |
| DIGNST - 21 x 24 <i>Spacer Table</i> | 542 | 738 | 890 | 27 | 2 |

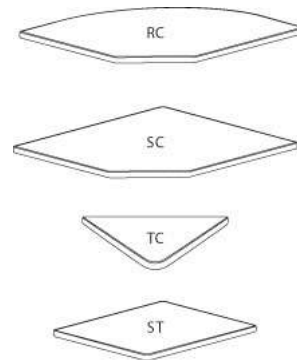

BEHAVIORAL HEALTH & HEAVY DUTY Specialty Tables

DIGNITY2

Standard Features

- Tops in laminate or veneer
- Select from 15 standard laminates or choose any standard Wilsonart, Nevamar, Formica, Arborite and Pionite matte finish laminates at no upcharge.
- Laminate tops with PVC Flat (PVF), Self Edge (SE), or hardwood (HB) edge
- 9 standard veneer and hardwood edge stains. Stain-to-match available at no upcharge.
- Tops utilize NU Green earth friendly core
- 18" height
- Non-removable steel levelling glides

Radius Corner Tables are recommended for open areas

Options

- Additional weight can be added, contact factory
- Non-standard laminates, contact Spec for pricing
- Floor mounting straps available, call Customer Service

Freestanding Lounge Tables

| Model | Laminate PVF/SE Edge | Laminate HB Edge | Veneer HB Edge | Weight | Cu.Ft. |
|--------------------|----------------------|------------------|----------------|--------|--------|
| DIGN2 - 24 x 24 SQ | 1221 | 1418 | 1455 | 62 | 7.2 |
| DIGN2 - 30 x 30 SQ | 1376 | 1518 | 1569 | 80 | 13.5 |
| DIGN2 - 36 x 36 SQ | 1503 | 1725 | 1787 | 101 | 18 |
| DIGN2 - 42 x 42 SQ | 1826 | 2149 | 2247 | 124 | 24.5 |
| DIGN2 - 48 x 48 SQ | 2023 | 2306 | 2411 | 151 | 32 |
| DIGN2 - 24 DIA | 1191 | 1550 | 1588 | 49 | 7.2 |
| DIGN2 - 30 DIA | 1343 | 1695 | 1744 | 61 | 13.5 |
| DIGN2 - 36 DIA | 1483 | 1998 | 2085 | 76 | 18 |
| DIGN2 - 42 DIA | 1815 | 2388 | 2511 | 93 | 24.5 |
| DIGN2 - 48 DIA | 1877 | 2651 | 2785 | 111 | 32 |



Corner and Spacer Connecting Tables

| Model | Laminate PVF/SE | Laminate HB Edge | Veneer HB Edge | Weight | Cu.Ft. |
|---|-----------------|------------------|----------------|--------|--------|
| DIGN2RC - 28 x 28 <i>Radius Corner Table</i> | 704 | 882 | 1091 | 31 | 2 |
| DIGN2SC - 28 x 28 <i>Square Corner Table</i> | 704 | 882 | 1091 | 32 | 2 |
| DIGN2TC - 45 degree <i>Corner Table</i> | 704 | 882 | 1091 | 26 | 2 |
| DIGN2ST - 21 x 24 <i>Spacer Table</i> | 542 | 738 | 890 | 27 | 2 |



Dignity2 seating is available connected as 1, 2 and 3 seaters, with or without arms between, with corner or spacer tables. Above pricing includes connector bars.



BEHAVIORAL HEALTH & HEAVY DUTY Specialty Tables

DRUM HD, CUBE HD, OVAL HD

NOTES AND OPTIONS

- Select from 15 standard laminates or choose any standard Wilsonart, Nevamar, Formica, Arborite and Pionite matte finish laminates at no upcharge. For other laminate please contact the factory for pricing.
- 9 standard veneer and hardwood edge stains. Stain-to-match available at no upcharge.
- Other sizes are available. Contact the factory for pricing.
- Solid surface tops are available. Contact the factory for pricing.
- Standard heights: 16", 18", 20", 22".



| MODEL | BASES | | TOP SPECIFICATIONS | | OPTIONS | LBS |
|------------------|---------------|-------------|--------------------|---------------|------------------|-----|
| | <i>Code</i> | <i>Qty.</i> | <i>Laminate</i> | <i>Veneer</i> | <i>Kickplate</i> | |
| | | | SE | SE | KP | |
| <i>Round</i> | | | | | | |
| 18D | DRMHD | 1 | 820 | 861 | 51 | 78 |
| 24D | DRMHD | 1 | 864 | 909 | 51 | 92 |
| 30D | DRMHD | 1 | 1077 | 1125 | 51 | 106 |
| 36D | DRMHD | 1 | 1217 | 1266 | 51 | 121 |
| 42D | DRMHD | 1 | 1346 | 1432 | 51 | 138 |
| <i>Square</i> | | | | | | |
| 18 x 18SQ | CUBEHD | 1 | 630 | 861 | 51 | 81 |
| 24 x 24SQ | CUBEHD | 1 | 664 | 908 | 51 | 100 |
| 30 x 30SQ | CUBEHD | 1 | 825 | 999 | 51 | 113 |
| 36 x 36SQ | CUBEHD | 1 | 954 | 1539 | 51 | 150 |
| <i>Oval</i> | | | | | | |
| 30 x 36 | OVALHD | 1 | 1775 | 1847 | 75 | 122 |
| 30 x 42 | OVALHD | 1 | 1963 | 2091 | 75 | 135 |
| 30 x 48 | OVALHD | 1 | 2481 | 2612 | 75 | 148 |



DRMHD



CUBEHD



OVALHD







BEHAVIORAL HEALTH & HEAVY DUTY Specialty Tables

TRUMPET HD, DISC HD

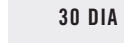
NOTES AND OPTIONS

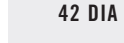
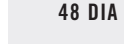
- Select from 15 standard laminates or choose any standard Wilsonart, Nevamar, Formica, Arborite and Pionite matte finish laminates at no upcharge. For other laminate please contact the factory for pricing.
- 9 standard veneer and hardwood edge stains. Stain-to-match available at no upcharge.
- Standard table height: 29". Customs available.
- All bases are standard with floor leveling glides.
- Chrome bases may be available as an upcharge. Please contact the factory.

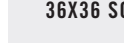
| MODEL <i>Size / Shape</i> | BASES | | TOP SPECIFICATIONS | | | | | | OPTIONS | MOBILITY | LBS |
|--|-------------|------------|-------------------------|----------|--------------------|-----------------------------|--------------------------------|-----------------------------|---------|----------|-----|
| | <i>Code</i> | <i>#of</i> | <i>For Laminate Top</i> | | | <i>For Veneer Top</i> | | | | | |
| | | | SE PVF 2MM | HF HB | HBV HBVR HBG | HF2 HB2 HKNR4 HBG2 | HF HB HBV HBVR HBG | HF2 HB2 HKNR4 HBG2 | | | |
|  24 DIA | TRHD | 1 | 887 | 1247 | 1284 | 1393 | 1452 | 1564 | | | 99 |
| | DISCHD | 1 | 1139 | 1499 | 1536 | 1645 | 1704 | 1816 | | | 116 |
|  30 DIA | TRHD | 1 | 991 | 1346 | 1393 | 1611 | 1556 | 1720 | | | 109 |
| | DISCHD | 1 | 1243 | 1598 | 1645 | 1863 | 1808 | 1972 | | | 126 |
|  36 DIA | TRHD | 1 | 1090 | 1603 | 1694 | 1872 | 1926 | 2155 | | | 120 |
| | DISCHD | 1 | 1342 | 1855 | 1946 | 2124 | 2178 | 2407 | | | 137 |
|  42 DIA | TRHD | 1 | 1375 | 1951 | 2075 | 2340 | 2366 | 2679 | | | 134 |
| | DISCHD | 1 | 1627 | 2203 | 2327 | 2592 | 2618 | 2931 | | | 161 |
|  48 DIA | TRHD | 1 | 1398 | 2171 | 2306 | 2438 | 2912 | 3314 | | | 150 |
| | DISCHD | 1 | 1650 | 2423 | 2558 | 2690 | 3164 | 3566 | | | 177 |
|  24X24 SQ | TRHD | 1 | 918 | 1113 | 1150 | 1218 | 1268 | 1435 | | | 99 |
| | DISCHD | 1 | 1277 | 1419 | 1470 | 1650 | 1584 | 1816 | | | 136 |
|  30X30 SQ | TRHD | 1 | 1025 | 1167 | 1218 | 1398 | 1332 | 1564 | | | 106 |
| | DISCHD | 1 | 1277 | 1419 | 1470 | 1650 | 1584 | 1816 | | | 136 |
|  36X36 SQ | TRHD | 1 | 1108 | 1331 | 1393 | 1603 | 1611 | 1811 | | | 120 |
| | DISCHD | 1 | 1360 | 1583 | 1645 | 1855 | 1863 | 2063 | | | 147 |



Weighted Trumpet Base



Weighted Disc Base



Weighted Trumpet Base
Lounge Height



BEHAVIORAL HEALTH & HEAVY DUTY Specialty Tables

TRAFFIC DINING

Standard Features

- Tabletop standard in Laminate with PVC Flat (PVF), 2MM or Self Edge (SE)
- Select from 15 standard laminates or choose any standard Wilsonart, Nevamar, Formica, Arborite and Pionite matte finish laminates at no upcharge. For other laminate please contact the factory for pricing.
- PVC Flat edge and 2mm Bio edge available in 38 solid colors. 2mm PVC edge available in wood grain to match 9 standard stains.
- Floor Mounting plates
- Tamperproof fasteners
- Welded steel end caps

Options

- 30" Bariatric seats are available. Contact factory for pricing
- Coated steel tabletop available. Contact factory for pricing
- CAL 133

Contact Spec Customer Service to railroad fabrics (specify repeat info and yardage requirement will be provided) and for repeats greater than 5" x 5"



Traffic Dining without arms, without upholstered cushions

N/A COM per single seat

| MODEL | PRICE |
|----------------|-------------|
| 7100NHD | 4920 |

Dimensions (inches)

| | | | | | | | |
|---------|-------|---------|------|------------|-------|-------------|------|
| seat H | 18.0 | seat W | 22.0 | table top | 30x48 | table H | 29.0 |
| total H | 33.75 | total W | 48.0 | seat depth | 17.0 | total depth | 74 |

Exceeds BIFMA Seating Durability Test to 500 lbs per chair

Traffic Dining without arms, with upholstered cushions

0.75 yd COM per single seat and back

| MODEL | COM | GR 1 | GR 2 | GR 3 | GR 4 | GR 5 | GR 6 |
|----------------|-------------|-------------|-------------|-------------|-------------|-------------|-------------|
| 7100UHD | 4999 | 5167 | 5223 | 5365 | 5535 | 5665 | 5832 |

Dimensions (inches)

| | | | | | | | |
|---------|-------|---------|------|------------|-------|-------------|------|
| seat H | 18.0 | seat W | 22.0 | table top | 30x48 | table H | 29.0 |
| total H | 33.75 | total W | 48.0 | seat depth | 17.0 | total depth | 74 |

Exceeds BIFMA Seating Durability Test to 500 lbs per chair

CAL 133, add \$240 List per unit



MANHATTAN TABLES



PRODUCT CODE

2430 RE M N T

Top Size

Width x Length

Top Shape

- D : Round
- SQ : Square
- RE : Rectangle
- RT : Racetrack
- B : Bullet
- H : Halfmoon
- TP : Trapezoid

Series

Manhattan

Leg

- N : Round Column
- R : Rectangle Column

Base

- X : X-Base
- X4 : 4 Column X-Base
- T : T-Base
- C : C-Base
- T2 : Double Column T-Base
- T2D : T2 with Door
- TRVWM-FR : with Footring

OPTIONS

FLIP TOP



CASTERS



FOLDING



ELECTRIC HEIGHT ADJUSTABLE



VERTICAL WIRE MANAGER



Oval

Rectangular

MEDIA WALL



FINISHES

LAMINATE



Select from 15 standard laminates or choose any standard Wilsonart, Nevamar, Formica, Arborite and Pionite matte finish laminates at no upcharge

VENEER



Select from one of our 9 standard wood stains or stain-to-match at no upcharge

BASE



Select from one of our 76 standard Spectone colors

EDGE



See Spectone Card or specfurniture.com/materials/finishes for a complete list of finish options and colors.



MANHATTAN TABLES

HOW TO ORDER

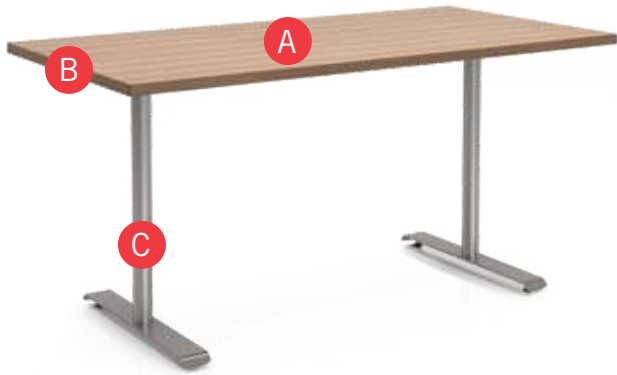

Specify Top Size (Width x Length) and Shape

- A** Specify Top Type and Finish
For Laminate Top: Manufacturer, Laminate Name, Laminate Code
For Veneer Top: Wood Stain
- B** Specify Edge Type, (for hardwood: Style), and Finish
PVC/2mm/Self Edge/Exposed Baltic Birch Plywood/Hardwood
- C** Specify Base Style and Finish
 Optional: Flip Top, Fold, Bar Height, Hard Casters, Soft Casters, Grommets, Seam Connectors, Modesty Panels, Adjustable Height, Power and Data Modules, Wire Management Solutions, Custom Solutions

Restrictions may apply. See price list tables below for more information.

| Top Size and Shape | Top Type and Finish | Edge Type and Finish | Base Style and Finish |
|--------------------|---------------------------------|--|-----------------------|
| 36 x 96, Rectangle | Laminate, Arborite, Brown Sugar | Hardwood, HF, Custom Brown Sugar Stain | MNT, Silver |



EDGE PROFILES

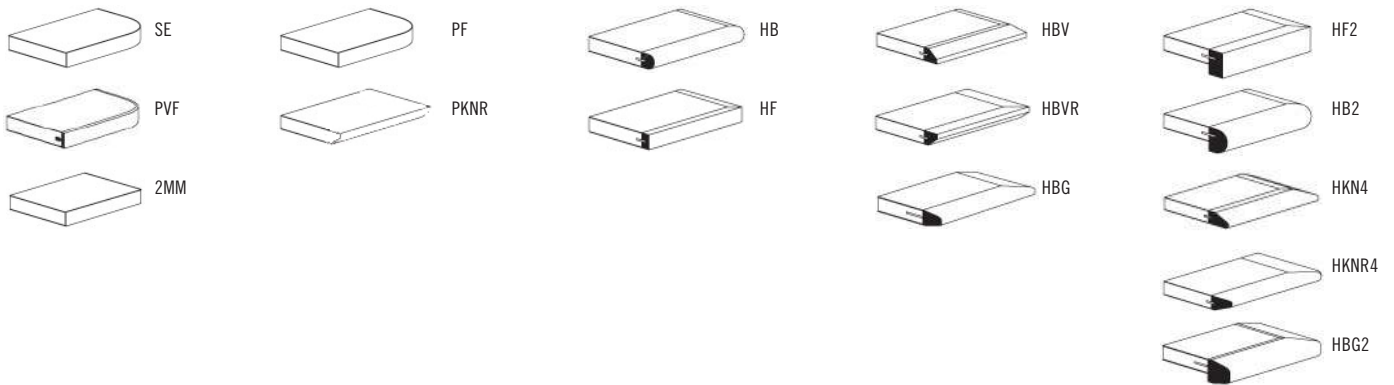



BACK TO CONTENTS

MANHATTAN TABLES GENERAL PURPOSE



| MODEL | BASES | | TOP SPECIFICATIONS | | | | | | OPTIONS | | | MOBILITY | | LBS |
|------------------------|----------|------|--------------------|---|--------------|--------------------|----------------|--------------------|---------------|------------|------------|-------------------|------------|-----|
| | Code | Qty. | For Laminate Top | | | For Veneer Top | | | FLIP TOP (FT) | FOLD (FL) | BAR HEIGHT | CASTERS HARD (HC) | SOFT (SC) | |
| | | | SE PVF 2MM | HF HB PKNR ¹ PF ¹ | HBV HBVR HBG | HF2 HB2 HKNR4 HBG2 | HF HB HBVR HBG | HF2 HB2 HKNR4 HBG2 | | | | | | |
| <i>Round</i> | | | | | | | | | | | | | | |
| 24D | MNX | 1 | 621 | 981 | 1018 | 1127 | 1186 | 1298 | 154 | | 38 | 96 | 204 | 34 |
| 30D | MNX | 1 | 725 | 1080 | 1127 | 1345 | 1290 | 1454 | 154 | | 38 | 96 | 204 | 44 |
| 36D ² | MNX | 1 | 824 | 1337 | 1428 | 1606 | 1660 | 1889 | 154 | | 38 | 96 | 204 | 55 |
| 42D | MNX | 1 | 1109 | 1685 | 1809 | 2074 | 2100 | 2413 | 154 | | | 96 | 204 | 69 |
| 42D ² | MNX4 | 1 | 1230 | 1806 | 1930 | 2195 | 2221 | 2534 | | | | 96 | 204 | 88 |
| 48D | MNX4 | 1 | 1253 | 2026 | 2161 | 2293 | 2767 | 3169 | | | | 96 | 204 | 107 |
| <i>Square</i> | | | | | | | | | | | | | | |
| 24 X 24SQ | MNX | 1 | 652 | 847 | 884 | 952 | 1002 | 1169 | 154 | | 38 | 96 | 204 | 34 |
| 30 X 30SQ | MNX | 1 | 759 | 901 | 952 | 1132 | 1066 | 1298 | 154 | | 38 | 96 | 204 | 44 |
| 36 X 36SQ ² | MNX | 1 | 842 | 1065 | 1127 | 1337 | 1345 | 1545 | 154 | | 38 | 96 | 204 | 55 |
| 42 X 42SQ | MNX4 | 1 | 1244 | 1567 | 1666 | 1766 | 1835 | 2108 | | | | 96 | 204 | 91 |
| 48 X 48SQ | MNX4 | 1 | 1398 | 1681 | 1786 | 1833 | 2211 | 2564 | | | | 96 | 204 | 107 |
| <i>Rectangle</i> | | | | | | | | | | | | | | |
| 20 X 42RE | MNT, MNC | 2 | 815 | 1030 | 1086 | 1187 | 1248 | 1429 | 310 | | | 96 | 204 | 69 |
| 20 X 48RE | MNT, MNC | 2 | 815 | 1030 | 1086 | 1187 | 1248 | 1429 | 310 | | | 96 | 204 | 71 |
| 20 X 54RE | MNT, MNC | 2 | 876 | 1189 | 1259 | 1375 | 1462 | 1684 | 310 | | | 96 | 204 | 74 |
| 20 X 60RE | MNT, MNC | 2 | 876 | 1189 | 1259 | 1375 | 1462 | 1684 | 310 | 297 | | 96 | 204 | 79 |
| 20 X 66RE | MNT, MNC | 2 | 1024 | 1401 | 1487 | 1629 | 1720 | 1992 | 310 | 297 | | 96 | 204 | 83 |
| 20 X 72RE | MNT, MNC | 2 | 1024 | 1401 | 1487 | 1629 | 1720 | 1992 | 310 | 297 | | 96 | 204 | 88 |

*Folding tables available with PVC Flat (PVF) edge only.

¹ Exposed Baltic Birch plywood edge (PKNR, PF) can only be specified on square or rectangle tops up to 47-1/2" x 95-1/2". Clear finish only.



² Available on Spec 10 Day Program

STANDARD FEATURES

- Select from 15 standard laminates or choose any standard Wilsonart, Nevamar, Formica, Arborite and Pionite matte finish laminates at no upcharge. For other laminate please contact the factory for pricing.
- 9 standard veneer and hardwood edge stains. Stain-to-match available at no upcharge.
- Standard with leveling glides.
- Bases available in any Spectone color.
- Standard 29" table height.
- Locking Casters are not self-leveling.
- Base span increases with size of top.

OPTIONS

- For Oval (VWM) or Rectangular (RVWM) vertical wire manager see the end of this section. For all other accessories, including modesty panels or applicable Power & Data modules, please see Table Accessories Price List.

HOW TO ORDER

1. Select Model
2. Select Base
3. Select Edge Style
4. Select Options
5. Select Top Finish
6. Select Edge Finish
7. Select Base Finish

Example: 24D - MNX - PVF -
 MODEL | BASE | EDGE | OPTIONS



MANHATTAN TABLES GENERAL PURPOSE

| MODEL | BASES | | TOP SPECIFICATIONS | | | | | | OPTIONS | | MOBILITY | | LBS |
|------------------------|----------|------|--------------------|---|--------------|--------------------|--------------------|--------------------|---------------|------------|-------------------|------------|-----|
| | Code | Qty. | For Laminate Top | | | For Veneer Top | | | FLIP TOP (FT) | FOLD* (FL) | CASTERS HARD (HC) | SOFT (SC) | |
| | | | SE PVF 2MM | HF HB PKNR ¹ PF ¹ | HBV HBVR HBG | HF2 HB2 HKNR4 HBG2 | HF HB HBV HBVR HBG | HF2 HB2 HKNR4 HBG2 | | | | | |
| <i>Rectangle</i> | | | | | | | | | | | | | |
| 24 X 30RE | MNX | 1 | 748 | 880 | 929 | 997 | 1050 | 1181 | 154 | | | | 43 |
| 24 X 30RE | MNT, MNC | 2 | 750 | 882 | 931 | 999 | 1052 | 1183 | 310 | | 96 | 204 | 58 |
| 24 X 36RE | MNX | 1 | 748 | 880 | 929 | 997 | 1050 | 1181 | 154 | | | | 48 |
| 24 X 36RE | MNT, MNC | 2 | 750 | 882 | 931 | 999 | 1052 | 1183 | 310 | | 96 | 204 | 63 |
| 24 X 42RE | MNT, MNC | 2 | 815 | 1030 | 1086 | 1187 | 1248 | 1429 | 310 | | 96 | 204 | 66 |
| 24 X 48RE ² | MNT, MNC | 2 | 815 | 1030 | 1086 | 1187 | 1248 | 1429 | 310 | | 96 | 204 | 71 |
| 24 X 54RE | MNT, MNC | 2 | 876 | 1189 | 1259 | 1375 | 1462 | 1684 | 310 | | 96 | 204 | 74 |
| 24 X 60RE ² | MNT, MNC | 2 | 876 | 1189 | 1259 | 1375 | 1462 | 1684 | 310 | 297 | 96 | 204 | 79 |
| 24 X 66RE | MNT, MNC | 2 | 1024 | 1401 | 1487 | 1629 | 1720 | 1992 | 310 | 297 | 96 | 204 | 83 |
| 24 X 72RE | MNT, MNC | 2 | 1024 | 1401 | 1487 | 1629 | 1720 | 1992 | 310 | 297 | 96 | 204 | 88 |

*Folding tables available with PVC Flat (PVF) edge only.

¹ Exposed Baltic Birch plywood edge (PKNR, PF) can only be specified on square or rectangle tops up to 47-1/2" x 95-1/2". Clear finish only.



² Available on Spec™ 10 Day Program



MNX



MNT



MNC

STANDARD FEATURES

- Select from 15 standard laminates or choose any standard Wilsonart, Nevamar, Formica, Arborite and Pionite matte finish laminates at no upcharge. For other laminate please contact the factory for pricing.
- 9 standard veneer and hardwood edge stains. Stain-to-match available at no upcharge.
- Standard with leveling glides.
- Bases available in any Spectone color.
- Standard 29" table height.
- Locking Casters are not self-leveling.
- Base span increases with size of top.

OPTIONS

- For Oval (VWM) or Rectangular (RVWM) vertical wire manager see the end of this section. For all other accessories, including modesty panels or applicable Power & Data modules, please see Table Accessories Price List.

HOW TO ORDER

1. Select Model
2. Select Base
3. Select Edge Style
4. Select Options
5. Select Top Finish
6. Select Edge Finish
7. Select Base Finish

Example: 2430RE- MNX - PVF -





MANHATTAN TABLES GENERAL PURPOSE

| MODEL | BASES | | TOP SPECIFICATIONS | | | | | | OPTIONS | | MOBILITY | | LBS | |
|------------------------|----------|------|--------------------|---|--------------|-------------------|--------------------|-------------------|---------------|------------|-------------------|-----------|------------|-----|
| | Code | Qty. | For Laminate Top | | | For Veneer Top | | | FLIP TOP (FT) | FOLD* (FL) | CASTERS HARD (HC) | SOFT (SC) | | |
| | | | SE PVF 2MM | HF HB PKNR ¹ PF ¹ | HBV HBVR HBG | HF2 HB2 HKN4 HBG2 | HF HB HBV HBVR HBG | HF2 HB2 HKN4 HBG2 | | | | | | |
| <i>Rectangle</i> | | | | | | | | | | | | | | |
| 30 X 36RE | MNX | 1 | 842 | 997 | 1051 | 1140 | 1202 | 1360 | | 154 | | 96 | 204 | 59 |
| 30 X 36RE | MNT, MNC | 2 | 844 | 999 | 1053 | 1142 | 1204 | 1362 | | 310 | | 96 | 204 | 64 |
| 30 X 42RE | MNT, MNC | 2 | 866 | 1160 | 1227 | 1343 | 1429 | 1649 | | 310 | | 96 | 204 | 74 |
| 30 X 48RE | MNT, MNC | 2 | 866 | 1160 | 1227 | 1343 | 1429 | 1649 | | 310 | | 96 | 204 | 79 |
| 30 X 54RE | MNT, MNC | 2 | 927 | 1327 | 1414 | 1580 | 1678 | 1954 | | 310 | | 96 | 204 | 85 |
| 30 X 60RE ² | MNT, MNC | 2 | 927 | 1327 | 1414 | 1580 | 1678 | 1954 | | 310 | 297 | 96 | 204 | 90 |
| 30 X 66RE | MNT, MNC | 2 | 1103 | 1428 | 1534 | 1701 | 1797 | 2102 | | 310 | 297 | 96 | 204 | 95 |
| 30 X 72RE ² | MNT, MNC | 2 | 1161 | 1584 | 1691 | 1907 | 2020 | 2356 | | 310 | 297 | 96 | 204 | 100 |
| 30 X 78RE | MNT, MNC | 2 | 1389 | 1764 | 1891 | 2142 | 2274 | 2660 | | 310 | 297 | 96 | 204 | 106 |
| 30 X 84RE | MNT, MNC | 2 | 1389 | 1764 | 1891 | 2142 | 2274 | 2660 | | 310 | 297 | 96 | 204 | 111 |
| 30 X 90RE | MNT, MNC | 2 | 1411 | 1989 | 2142 | 2374 | 2530 | 2970 | | 310 | 297 | 96 | 204 | 116 |
| 30 X 96RE | MNT, MNC | 2 | 1411 | 1989 | 2142 | 2374 | 2530 | 2970 | | 310 | 297 | 96 | 204 | 121 |

*Folding tables available with PVC Flat (PVF) edge only.

¹ Exposed Baltic Birch plywood edge (PKNR, PF) can only be specified on square or rectangle tops up to 47-1/2" x 95-1/2". Clear finish only.



² Available on Spec 10 Day Program



MNX



MNT



MNC

STANDARD FEATURES

- Select from 15 standard laminates or choose any standard Wilsonart, Nevamar, Formica, Arborite and Pionite matte finish laminates at no upcharge. For other laminate please contact the factory for pricing.
- 9 standard veneer and hardwood edge stains. Stain-to-match available at no upcharge.
- Standard with leveling glides.
- Bases available in any Spectone color.
- Standard 29" table height.
- Locking Casters are not self-leveling.
- Base span increases with size of top.

OPTIONS

- For Oval (**VWM**) or Rectangular (**RVWM**) vertical wire manager see the end of this section. For all other accessories, including modesty panels or applicable Power & Data modules, please see Table Accessories Price List.

HOW TO ORDER

1. Select Model
2. Select Base
3. Select Edge Style
4. Select Options
5. Select Top Finish
6. Select Edge Finish
7. Select Base Finish

Example: 3036RE- MNX - PVF -





BACK TO CONTENTS

MANHATTAN TABLES GENERAL PURPOSE

| MODEL | BASES | | TOP SPECIFICATIONS | | | | | | OPTIONS | | MOBILITY | | LBS |
|------------------|----------|------|--------------------|---|--------------|-------------------|--------------------|-------------------|---------------|------------|-------------------|------------|-----|
| | Code | Qty. | For Laminate Top | | | For Veneer Top | | | FLIP TOP (FT) | FOLD* (FL) | CASTERS HARD (HC) | SOFT (SC) | |
| | | | SE PVF 2MM | HF HB PKNR ¹ PF ¹ | HBV HBVR HBG | HF2 HB2 HKN4 HBG2 | HF HB HBV HBVR HBG | HF2 HB2 HKN4 HBG2 | | | | | |
| <i>Rectangle</i> | | | | | | | | | | | | | |
| 36 X 42RE | MNT, MNC | 2 | 968 | 1189 | 1273 | 1388 | 1478 | 1709 | 310 | | 96 | 204 | 88 |
| 36 X 48RE | MNT, MNC | 2 | 993 | 1305 | 1396 | 1534 | 1625 | 1896 | 310 | | 96 | 204 | 88 |
| 36 X 54RE | MNT, MNC | 2 | 1073 | 1410 | 1514 | 1668 | 1784 | 2080 | 310 | | 96 | 204 | 90 |
| 36 X 60RE | MNT, MNC | 2 | 1092 | 1526 | 1636 | 1812 | 1923 | 2261 | 310 | 297 | 96 | 204 | 95 |
| 36 X 66RE | MNT, MNC | 2 | 1182 | 1632 | 1759 | 1952 | 2074 | 2445 | 310 | 297 | 96 | 204 | 94 |
| 36 X 66RE | MNT2 | 2 | 1512 | 1962 | 2089 | 2282 | 2404 | 2775 | | 597 | 96 | 204 | 108 |
| 36 X 72RE | MNT | 2 | 1221 | 1691 | 1812 | 2091 | 2227 | 2628 | 310 | 297 | 96 | 204 | 107 |
| 36 X 72RE | MNT2 | 2 | 1551 | 2021 | 2142 | 2421 | 2557 | 2958 | | 597 | 96 | 204 | 115 |
| 36 X 78RE | MNT | 2 | 1562 | 2065 | 2223 | 2466 | 2624 | 3097 | 310 | 297 | 96 | 204 | 114 |
| 36 X 78RE | MNT2 | 2 | 1892 | 2395 | 2553 | 2796 | 2954 | 3427 | | 597 | 96 | 204 | 121 |
| 36 X 84RE | MNT | 2 | 1562 | 2065 | 2223 | 2466 | 2624 | 3097 | 310 | 297 | 96 | 204 | 120 |
| 36 X 84RE | MNT2 | 2 | 1892 | 2395 | 2553 | 2796 | 2954 | 3427 | | 597 | 96 | 204 | 127 |
| 36 X 90RE | MNT | 2 | 1569 | 2286 | 2466 | 2749 | 2931 | 3455 | 310 | 297 | 96 | 204 | 126 |
| 36 X 90RE | MNT2 | 2 | 1899 | 2616 | 2796 | 3079 | 3261 | 3785 | | 597 | 96 | 204 | 133 |
| 36 X 96RE | MNT | 2 | 1569 | 2286 | 2466 | 2749 | 2931 | 3455 | 310 | 297 | 96 | 204 | 132 |
| 36 X 96RE | MNT2 | 2 | 1899 | 2616 | 2796 | 3079 | 3261 | 3785 | | 597 | 96 | 204 | 135 |
| 42 X 78RE | MNT2 | 2 | 2140 | 2572 | 2745 | 3163 | 3300 | 3848 | | 597 | 96 | 204 | 143 |
| 42 X 84RE | MNT2 | 2 | 2140 | 2572 | 2745 | 3163 | 3300 | 3848 | | 597 | 96 | 204 | 148 |

*Folding tables available with PVC Flat (PVF) edge only.

¹ Exposed Baltic Birch plywood edge (PKNR, PF) can only be specified on square or rectangle tops up to 47-1/2" x 95-1/2". Clear finish only.



MNT



MNC



MNT2

STANDARD FEATURES

- Select from 15 standard laminates or choose any standard Wilsonart, Nevamar, Formica, Arborite and Pionite matte finish laminates at no upcharge. For other laminate please contact the factory for pricing.
- 9 standard veneer and hardwood edge stains. Stain-to-match available at no upcharge.
- Standard with leveling glides.
- Bases available in any Spectone color.
- Standard 29" table height.
- Locking Casters are not self-leveling.
- Base span increases with size of top.

OPTIONS

- For Oval (VWM) or Rectangular (RVWM) vertical wire manager see the end of this section. For all other accessories, including modesty panels or applicable Power & Data modules, please see Table Accessories Price List.

HOW TO ORDER

1. Select Model
2. Select Base
3. Select Edge Style
4. Select Options
5. Select Top Finish
6. Select Edge Finish
7. Select Base Finish

Example: 3642RE - MNT - PVF -





BACK TO CONTENTS

MANHATTAN TABLES GENERAL PURPOSE



| MODEL | BASES | | TOP SPECIFICATIONS | | | | | | OPTIONS | MOBILITY | | LBS |
|------------------|-------|------|--------------------|--|--------------------|-------------------------------------|--------------------------------|-------------------------------------|---------|---------------|------------|-----|
| | Code | Qty. | For Laminate Top | | | For Veneer Top | | | | FLIP TOP (FT) | HARD (HC) | |
| | | | SE PVF 2MM | HF HB PKNR ¹ PF ¹ | HBV HBVR HBG | HF2 HB2 HKN4 HKNR4 HBG2 | HF HB HBV HBVR HBG | HF2 HB2 HKN4 HKNR4 HBG2 | | | | |
| <i>Racetrack</i> | | | | | | | | | | | | |
| 36 X 54RT | MNT | 2 | 1149 | 1720 | 1853 | 2091 | 2189 | 2538 | 310 | 96 | 204 | 84 |
| 36 X 54RT | MNT2 | 2 | 1479 | 2050 | 2183 | 2421 | 2519 | 2868 | | 96 | 204 | 90 |
| 36 X 60RT | MNT | 2 | 1149 | 1720 | 1853 | 2091 | 2189 | 2538 | 310 | 96 | 204 | 89 |
| 36 X 60RT | MNT2 | 2 | 1479 | 2050 | 2183 | 2421 | 2519 | 2868 | | 96 | 204 | 95 |
| 36 X 66RT | MNT | 2 | 1310 | 1907 | 2051 | 2306 | 2530 | 2966 | 310 | 96 | 204 | 94 |
| 36 X 66RT | MNT2 | 2 | 1640 | 2237 | 2381 | 2636 | 2860 | 3296 | | 96 | 204 | 108 |
| 36 X 72RT | MNT | 2 | 1310 | 1907 | 2051 | 2306 | 2530 | 2966 | 310 | 96 | 204 | 107 |
| 36 X 72RT | MNT2 | 2 | 1640 | 2237 | 2381 | 2636 | 2860 | 3296 | | 96 | 204 | 115 |
| 36 X 78RT | MNT | 2 | 1580 | 2338 | 2515 | 2900 | 2981 | 3489 | 310 | 96 | 204 | 114 |
| 36 X 78RT | MNT2 | 2 | 1910 | 2668 | 2845 | 3230 | 3311 | 3819 | | 96 | 204 | 121 |
| 36 X 84RT | MNT | 2 | 1580 | 2338 | 2515 | 2900 | 2981 | 3489 | 310 | 96 | 204 | 120 |
| 36 X 84RT | MNT2 | 2 | 1910 | 2668 | 2845 | 3230 | 3311 | 3819 | | 96 | 204 | 127 |
| 36 X 90RT | MNT | 2 | 1584 | 2595 | 2806 | 3237 | 3338 | 3917 | 310 | 96 | 204 | 130 |
| 36 X 90RT | MNT2 | 2 | 1914 | 2925 | 3136 | 3567 | 3668 | 4247 | | 96 | 204 | 133 |
| 36 X 96RT | MNT | 2 | 1584 | 2595 | 2806 | 3237 | 3338 | 3917 | 310 | 96 | 204 | 130 |
| 36 X 96RT | MNT2 | 2 | 1914 | 2925 | 3136 | 3567 | 3668 | 4247 | | 96 | 204 | 135 |
| 42 X 78RT | MNT2 | 2 | 2155 | 2872 | 3089 | 3525 | 3630 | 4214 | | 96 | 204 | 143 |
| 42 X 84RT | MNT2 | 2 | 2155 | 2872 | 3089 | 3525 | 3630 | 4214 | | 96 | 204 | 148 |
| 48 X 78RT | MNT2 | 2 | 2158 | 3180 | 3426 | 3812 | 4053 | 4717 | | 96 | 204 | 143 |
| 48 X 84RT | MNT2 | 2 | 2158 | 3180 | 3426 | 3812 | 4053 | 4717 | | 96 | 204 | 148 |



MNT



MNT2

STANDARD FEATURES

- Select from 15 standard laminates or choose any standard Wilsonart, Nevamar, Formica, Arborite and Pionite matte finish laminates at no upcharge. For other laminate please contact the factory for pricing.
- 9 standard veneer and hardwood edge stains. Stain-to-match available at no upcharge.
- Standard with leveling glides.
- Bases available in any Spectone color.
- Standard 29" table height.
- Locking Casters are not self-leveling.
- Base span increases with size of top.

OPTIONS

- For Oval (VWM) or Rectangular (RVWM) vertical wire manager see the end of this section. For all other accessories, including modesty panels or applicable Power & Data modules, please see Table Accessories Price List.

HOW TO ORDER

1. Select Model
2. Select Base
3. Select Edge Style
4. Select Options
5. Select Top Finish
6. Select Edge Finish
7. Select Base Finish





BACK TO CONTENTS

MANHATTAN TABLES GENERAL PURPOSE



| MODEL | BASES | | TOP SPECIFICATIONS | | | | | | OPTIONS | MOBILITY | | LBS |
|--------------------|-------|------|--------------------|--|--------------------|-------------------------------------|--------------------------------|-------------------------------------|---------|---------------|------------|-----|
| | Code | Qty. | For Laminate Top | | | For Veneer Top | | | | FLIP TOP (FT) | HARD (HC) | |
| | | | SE PVF 2MM | HF HB PKNR ¹ PF ¹ | HBV HBVR HBG | HF2 HB2 HKN4 HKNR4 HBG2 | HF HB HBV HBVR HBG | HF2 HB2 HKN4 HKNR4 HBG2 | | | | |
| <i>Bullet</i> | | | | | | | | | | | | |
| 30 X 54B | MNT | 2 | 1048 | 1617 | 1736 | 1944 | 2006 | 2350 | 310 | 96 | 204 | 85 |
| 30 X 60B | MNT | 2 | 1048 | 1617 | 1736 | 1944 | 2006 | 2350 | 310 | 96 | 204 | 90 |
| 36 X 54B | MNT | 2 | 1171 | 2128 | 2297 | 2602 | 2644 | 3077 | 310 | 96 | 204 | 90 |
| 36 X 60B | MNT | 2 | 1171 | 2128 | 2297 | 2602 | 2644 | 3077 | 310 | 96 | 204 | 95 |
| 36 X 66B | MNT | 2 | 1309 | 2367 | 2554 | 2880 | 3069 | 3613 | 310 | 96 | 204 | 108 |
| 36 X 72B | MNT | 2 | 1309 | 2367 | 2554 | 2880 | 3069 | 3613 | 310 | 96 | 204 | 115 |
| <i>Halfmoon</i> | | | | | | | | | | | | |
| 24 X 48H | MNT | 2 | 833 | 1347 | 1476 | 1632 | 1759 | 2051 | 310 | 96 | 204 | 71 |
| 30 X 60H | MNT | 2 | 1048 | 1813 | 1990 | 2166 | 2386 | 2803 | 310 | 96 | 204 | 90 |
| 36 X 72H | MNT | 2 | 1309 | 2353 | 2584 | 2800 | 3157 | 3721 | 310 | 96 | 204 | 115 |
| <i>Trapezoid</i> | | | | | | | | | | | | |
| 30 X 60TP | MNT | 2 | 1048 | 1519 | 1629 | 1818 | 1873 | 2192 | 310 | 96 | 204 | 90 |
| 36 X 72TP | MNT | 2 | 1309 | 1948 | 2092 | 2420 | 2502 | 2962 | 310 | 96 | 204 | 115 |
| <i>Crescent</i> | | | | | | | | | | | | |
| 30 X 36RC90 | MNT | 2 | 1023 | 1709 | 1796 | 1864 | 2082 | 2321 | | 96 | 204 | 48 |
| 36 X 42RC90 | MNT | 2 | 1386 | 2030 | 2149 | 2238 | 2538 | 2862 | | 96 | 204 | 61 |



MNT



MNT2

STANDARD FEATURES

- Select from 15 standard laminates or choose any standard Wilsonart, Nevamar, Formica, Arborite and Pionite matte finish laminates at no upcharge. For other laminate please contact the factory for pricing.
- 9 standard veneer and hardwood edge stains. Stain-to-match available at no upcharge.
- Standard with leveling glides.
- Bases available in any Spectone color.
- Standard 29" table height.
- Locking Casters are not self-leveling.
- Base span increases with size of top.

OPTIONS

- For Oval (**VWM**) or Rectangular (**RVWM**) vertical wire manager see the end of this section. For all other accessories, including modesty panels or applicable Power & Data modules, please see Table Accessories Price List.

HOW TO ORDER

1. Select Model
2. Select Base
3. Select Edge Style
4. Select Options
5. Select Top Finish
6. Select Edge Finish
7. Select Base Finish

Example: 3054B - MNT - PVF -





MANHATTAN TABLES BOARDROOM

| MODEL | BASES | | TOP SPECIFICATIONS | | | | | | OPTIONS | LBS |
|------------------|-------|------|--------------------|--|--------------------|-------------------------------------|--------------------------------|-------------------------------------|---------|-----|
| | Code | Qty. | For Laminate Top | | | For Veneer Top | | | | |
| | | | SE PVF 2MM | HF HB PKNR ¹ PF ¹ | HBV HBVR HBG | HF2 HB2 HKN4 HKNR4 HBG2 | HF HB HBV HBVR HBG | HF2 HB2 HKN4 HKNR4 HBG2 | | |
| <i>Rectangle</i> | | | | | | | | | | |
| 42 X 96RE | MNT2 | 2 | 2193 | 3103 | 3349 | 3598 | 3966 | 4678 | | 175 |
| 42 X 96RE | MNT2D | 2 | 3355 | 4265 | 4511 | 4760 | 5128 | 5840 | | 185 |
| 48 X 96RE | MNT2 | 2 | 2193 | 3103 | 3349 | 3598 | 3966 | 4678 | | 179 |
| 48 X 96RE | MNT2D | 2 | 3355 | 4265 | 4511 | 4760 | 5128 | 5840 | | 189 |
| 48 X 120RE | MNT2 | 3 | 2918 | 4093 | 4371 | 4972 | 5060 | 5893 | | 228 |
| 48 X 120RE | MNT2D | 3 | 4661 | 5836 | 6114 | 6715 | 6803 | 7636 | | 238 |
| 48 X 144RE | MNT2 | 3 | 3314 | 4999 | 5366 | 5937 | 5801 | 6803 | | 262 |
| 48 X 144RE | MNT2D | 3 | 5057 | 6742 | 7109 | 7680 | 7544 | 8546 | | 272 |
| 48 X 168RE | MNT2 | 3 | 3818 | 5514 | 5933 | 6730 | 6546 | 7710 | | 296 |
| 48 X 168RE | MNT2D | 3 | 5561 | 7257 | 7676 | 8473 | 8289 | 9453 | | 306 |
| 60 X 120RE | MNT2 | 3 | 3402 | 5159 | 5543 | 6135 | 5994 | 7039 | | 270 |
| 60 X 120RE | MNT2D | 3 | 5145 | 6902 | 7286 | 7878 | 7737 | 8782 | | 280 |
| 60 X 144RE | MNT2 | 3 | 3850 | 5959 | 6418 | 7129 | 6961 | 8214 | | 312 |
| 60 X 144RE | MNT2D | 3 | 5593 | 7702 | 8161 | 8872 | 8704 | 9957 | | 322 |
| 60 X 168RE | MNT2 | 3 | 4300 | 6759 | 7293 | 8125 | 7928 | 9388 | | 354 |
| 60 X 168RE | MNT2D | 3 | 6043 | 8502 | 9036 | 9868 | 9671 | 11131 | | 364 |



¹ Exposed Baltic Birch plywood edge (PKNR, PF) can only be specified on square or rectangle tops up to 47-1/2" x 95-1/2". Clear finish only.



MNT2



MNT2D

STANDARD FEATURES

- Select from 15 standard laminates or choose any standard Wilsonart, Nevamar, Formica, Arborite and Pionite matte finish laminates at no upcharge. For other laminate please contact the factory for pricing.
- 9 standard veneer and hardwood edge stains. Stain-to-match available at no upcharge.
- Standard with leveling glides.
- Bases available in any Spectone color.
- Standard 29" table height.
- Locking Casters are not self-leveling.
- Base span increases with size of top.

OPTIONS

- For other table accessories, including modesty panels or applicable Power & Data modules, please see Table Accessories Price List.

HOW TO ORDER

1. Select Model
2. Select Base
3. Select Edge Style
4. Select Options
5. Select Top Finish
6. Select Edge Finish
7. Select Base Finish

Example: 4296RE - MNT2 - PVF -





BACK TO CONTENTS

MANHATTAN TABLES BOARDROOM



| MODEL | BASES | | TOP SPECIFICATIONS | | | | | | OPTIONS | LBS |
|------------------|-------|------|--------------------|----------|--------------------|-------------------------------------|--------------------------------|-------------------------------------|---------|-----|
| | Code | Qty. | For Laminate Top | | | For Veneer Top | | | | |
| | | | SE PVF 2MM | HF HB | HBV HBVR HBG | HF2 HB2 HKN4 HKNR4 HBG2 | HF HB HBV HBVR HBG | HF2 HB2 HKN4 HKNR4 HBG2 | | |
| <i>Racetrack</i> | | | | | | | | | | |
| 42 X 96RT | MNT2 | 2 | 2213 | 3242 | 3493 | 4096 | 4522 | 5281 | | 175 |
| 42 X 96RT | MNT2D | 2 | 3375 | 4404 | 4655 | 5258 | 5684 | 6443 | | 185 |
| 48 X 96RT | MNT2 | 2 | 2213 | 3242 | 3493 | 4096 | 4522 | 5281 | | 179 |
| 48 X 96RT | MNT2D | 2 | 3375 | 4404 | 4655 | 5258 | 5684 | 6443 | | 189 |
| 48 X 120RT | MNT2 | 3 | 2945 | 4577 | 4904 | 5735 | 5700 | 6587 | | 228 |
| 48 X 120RT | MNT2D | 3 | 4688 | 6320 | 6647 | 7478 | 7443 | 8330 | | 238 |
| 48 X 144RT | MNT2 | 3 | 3344 | 5377 | 5778 | 6808 | 6569 | 7645 | | 262 |
| 48 X 144RT | MNT2D | 3 | 5087 | 7120 | 7521 | 8551 | 8312 | 9388 | | 272 |
| 48 X 168RT | MNT2 | 3 | 3850 | 6061 | 6529 | 7673 | 7451 | 8698 | | 296 |
| 48 X 168RT | MNT2D | 3 | 5593 | 7804 | 8272 | 9416 | 9194 | 10441 | | 306 |
| 60 X 120RT | MNT2 | 3 | 3391 | 5431 | 5837 | 6881 | 6834 | 7947 | | 270 |
| 60 X 120RT | MNT2D | 3 | 5134 | 7174 | 7580 | 8624 | 8577 | 9690 | | 280 |
| 60 X 144RT | MNT2 | 3 | 3890 | 6431 | 6934 | 8224 | 7923 | 9267 | | 312 |
| 60 X 144RT | MNT2D | 3 | 5633 | 8174 | 8677 | 9967 | 9666 | 11010 | | 322 |
| 60 X 168RT | MNT2 | 3 | 4525 | 7290 | 7874 | 9300 | 9024 | 10582 | | 354 |
| 60 X 168RT | MNT2D | 3 | 6268 | 9033 | 9617 | 11043 | 10767 | 12325 | | 364 |



MNT2



MNT2D

STANDARD FEATURES

- Select from 15 standard laminates or choose any standard Wilsonart, Nevamar, Formica, Arborite and Pionite matte finish laminates at no upcharge. For other laminate please contact the factory for pricing.
- 9 standard veneer and hardwood edge stains. Stain-to-match available at no upcharge.
- Standard with leveling glides.
- Bases available in any Spectone color.
- Standard 29" table height.
- Locking Casters are not self-leveling.
- Base span increases with size of top.

OPTIONS

- For other table accessories, including modesty panels or applicable Power & Data modules, please see Table Accessories Price List.

HOW TO ORDER

1. Select Model
2. Select Base
3. Select Edge Style
4. Select Options
5. Select Top Finish
6. Select Edge Finish
7. Select Base Finish

Example: 4296RT - MNT2 - PVF -





MANHATTAN TABLES BOARDROOM



| MODEL | BASES | | TOP SPECIFICATIONS | | | | | | OPTIONS | LBS |
|------------------|-------|------|--------------------|----------|--------------------|-------------------------------------|--------------------------------|-------------------------------------|---------|-----|
| | Code | Qty. | For Laminate Top | | | For Veneer Top | | | | |
| | | | SE PVF 2MM | HF HB | HBV HBVR HBG | HF2 HB2 HKN4 HKNR4 HBG2 | HF HB HBV HBVR HBG | HF2 HB2 HKN4 HKNR4 HBG2 | | |
| <i>Boatshape</i> | | | | | | | | | | |
| 42 X 96BT | MNT2 | 2 | 2213 | 3944 | 4266 | 4598 | 5069 | 5483 | | 175 |
| 42 X 96BT | MNT2D | 2 | 3375 | 5106 | 5428 | 5760 | 6231 | 6645 | | 185 |
| 48 X 96BT | MNT2 | 2 | 2213 | 3944 | 4266 | 4598 | 5069 | 5483 | | 179 |
| 48 X 96BT | MNT2D | 2 | 3375 | 5106 | 5428 | 5760 | 6231 | 6645 | | 189 |
| 48 X 120BT | MNT2 | 3 | 2945 | 5346 | 5745 | 6167 | 6346 | 6825 | | 228 |
| 48 X 120BT | MNT2D | 3 | 4688 | 7089 | 7488 | 7910 | 8089 | 8568 | | 238 |
| 48 X 144BT | MNT2 | 3 | 3344 | 6147 | 6623 | 7129 | 7767 | 8202 | | 262 |
| 48 X 144BT | MNT2D | 3 | 5087 | 7890 | 8366 | 8872 | 9510 | 9945 | | 272 |
| 48 X 168BT | MNT2 | 3 | 3850 | 6912 | 7467 | 8051 | 8349 | 9021 | | 296 |
| 48 X 168BT | MNT2D | 3 | 5593 | 8655 | 9210 | 9794 | 10092 | 10764 | | 306 |
| 60 X 120 BT | MNT2 | 3 | 3391 | 6390 | 6893 | 7419 | 7645 | 8239 | | 270 |
| 60 X 120 BT | MNT2D | 3 | 5134 | 8133 | 8636 | 9162 | 9388 | 9982 | | 280 |
| 60 X 144BT | MNT2 | 3 | 3890 | 7395 | 7990 | 8623 | 9418 | 9964 | | 312 |
| 60 X 144BT | MNT2D | 3 | 5633 | 9138 | 9733 | 10366 | 11161 | 11707 | | 322 |
| 60 X 168BT | MNT2 | 3 | 4525 | 8353 | 9044 | 9775 | 10145 | 10987 | | 354 |
| 60 X 168BT | MNT2D | 3 | 6268 | 10096 | 10787 | 11518 | 11888 | 12730 | | 364 |



MNT2



MNT2D

STANDARD FEATURES

- Select from 15 standard laminates or choose any standard Wilsonart, Nevamar, Formica, Arborite and Pionite matte finish laminates at no upcharge. For other laminate please contact the factory for pricing.
- 9 standard veneer and hardwood edge stains. Stain-to-match available at no upcharge.
- Standard with leveling glides.
- Bases available in any Spectone color.
- Standard 29" table height.
- Locking Casters are not self-leveling.
- Base span increases with size of top.

OPTIONS

- For other table accessories, including modesty panels or applicable Power & Data modules, please see Table Accessories Price List.

HOW TO ORDER

1. Select Model
2. Select Base
3. Select Edge Style
4. Select Options
5. Select Top Finish
6. Select Edge Finish
7. Select Base Finish

Example: 4296BT - MNT2 - PVF -





BACK TO CONTENTS

MANHATTAN TABLES BOARDROOM



| MODEL | BASES | | TOP SPECIFICATIONS | | | | | | OPTIONS | LBS |
|-----------------|-------|------|--------------------|----------|--------------------|-----------------------------|--------------------------------|-----------------------------|---------|-----|
| | Code | Qty. | For Laminate Top | | | For Veneer Top | | | | |
| | | | SE PVF 2MM | HF HB | HBV HBVR HBG | HF2 HB2 HKNR4 HBG2 | HF HB HBV HBVR HBG | HF2 HB2 HKNR4 HBG2 | | |
| <i>Boat Arc</i> | | | | | | | | | | |
| 42 X 96BTA | MNT2 | 2 | 2389 | 4495 | 4819 | 5153 | 5621 | 6035 | | 175 |
| 42 X 96BTA | MNT2D | 2 | 3551 | 5657 | 5981 | 6315 | 6783 | 7197 | | 185 |
| 48 X 96BTA | MNT2 | 2 | 2389 | 4495 | 4819 | 5153 | 5621 | 6035 | | 179 |
| 48 X 96BTA | MNT2D | 2 | 3551 | 5657 | 5981 | 6315 | 6783 | 7197 | | 189 |
| 48 X 120BTA | MNT2 | 3 | 3120 | 5900 | 6300 | 6722 | 6901 | 7376 | | 228 |
| 48 X 120BTA | MNT2D | 3 | 4863 | 7643 | 8043 | 8465 | 8644 | 9119 | | 238 |
| 48 X 144BTA | MNT2 | 3 | 3520 | 6698 | 7178 | 7684 | 8318 | 8756 | | 262 |
| 48 X 144BTA | MNT2D | 3 | 5263 | 8441 | 8921 | 9427 | 10061 | 10499 | | 272 |
| 48 X 168BTA | MNT2 | 3 | 4027 | 7467 | 8022 | 8606 | 8902 | 9577 | | 296 |
| 48 X 168BTA | MNT2D | 3 | 5770 | 9210 | 9765 | 10349 | 10645 | 11320 | | 306 |
| 60 X 120 BTA | MNT2 | 3 | 3612 | 7085 | 7584 | 8111 | 8335 | 8930 | | 270 |
| 60 X 120 BTA | MNT2D | 3 | 5355 | 8828 | 9327 | 9854 | 10078 | 10673 | | 280 |
| 60 X 144BTA | MNT2 | 3 | 4109 | 8084 | 8683 | 9314 | 10110 | 10653 | | 312 |
| 60 X 144BTA | MNT2D | 3 | 5852 | 9827 | 10426 | 11057 | 11853 | 12396 | | 322 |
| 60 X 168BTA | MNT2 | 3 | 4744 | 9044 | 9736 | 10465 | 10838 | 11682 | | 354 |
| 60 X 168BTA | MNT2D | 3 | 6487 | 10787 | 11479 | 12208 | 12581 | 13425 | | 364 |



MNT2



MNT2D

STANDARD FEATURES

- Select from 15 standard laminates or choose any standard Wilsonart, Nevamar, Formica, Arborite and Pionite matte finish laminates at no upcharge. For other laminate please contact the factory for pricing.
- 9 standard veneer and hardwood edge stains. Stain-to-match available at no upcharge.
- Standard with leveling glides.
- Bases available in any Spectone color.
- Standard 29" table height.
- Locking Casters are not self-leveling.
- Base span increases with size of top.

OPTIONS

- For other table accessories, including modesty panels or applicable Power & Data modules, please see Table Accessories Price List.

HOW TO ORDER

1. Select Model
2. Select Base
3. Select Edge Style
4. Select Options
5. Select Top Finish
6. Select Edge Finish
7. Select Base Finish

Example: 4296BTA - MNT2 - PVF -





MANHATTAN TABLES ACCESSORIES

| MODEL | | |
|--|--|---|
| | <i>Code</i> | <i>Price</i> |
| <p>VERTICAL WIRE MANAGER*</p> <p>Attaches to single column T or C leg. Can be used in conjunction with Flip6. If ordering one vertical wire manager per table, specify right or left handed while sitting at the table.</p> <p>Cannot be used with Rectangular Column*</p> | <p>VWM 187</p> <p>RVWM 187</p> |  |





BACK TO CONTENTS

MANHATTAN TABLES - RECTANGLE COLUMN GENERAL PURPOSE

| MODEL | BASES | | TOP SPECIFICATIONS | | | | | | OPTIONS | | MOBILITY | | LBS |
|------------------|----------|------|--------------------|--|--------------------|-------------------------------------|--------------------------------|-------------------------------------|---------------|-------------------------|-------------------|------------|-----------------|
| | Code | Qty. | For Laminate Top | | | For Veneer Top | | | FLIP TOP (FT) | ELECTRIC HEIGHT | CASTERS HARD (HC) | SOFT (SC) | |
| | | | SE PVF 2MM | HF HB PKNR ¹ PF ¹ | HBV HBVR HBG | HF2 HB2 HKN4 HKNR4 HBG2 | HF HB HBV HBVR HBG | HF2 HB2 HKN4 HKNR4 HBG2 | | | | | |
| <i>Rectangle</i> | | | | | | | | | | | | | |
| 20 X 42RE | MRT, MRC | 2 | 857 | 1072 | 1128 | 1229 | 1290 | 1471 | 310 | 1202 ² | 96 | 204 | 69 ³ |
| 20 X 48RE | MRT, MRC | 2 | 857 | 1072 | 1128 | 1229 | 1290 | 1471 | 310 | 1202 ² | 96 | 204 | 71 ³ |
| 20 X 54RE | MRT, MRC | 2 | 918 | 1231 | 1301 | 1417 | 1504 | 1726 | 310 | 1202 ² | 96 | 204 | 74 ³ |
| 20 X 60RE | MRT, MRC | 2 | 918 | 1231 | 1301 | 1417 | 1504 | 1726 | 310 | 1202 ² | 96 | 204 | 79 ³ |
| 20 X 66RE | MRT, MRC | 2 | 1066 | 1443 | 1529 | 1671 | 1762 | 2034 | 310 | 1202 ² | 96 | 204 | 83 ³ |
| 20 X 72RE | MRT, MRC | 2 | 1066 | 1443 | 1529 | 1671 | 1762 | 2034 | 310 | 1202 ² | 96 | 204 | 88 ³ |
| 24 X 30RE | MRT, MRC | 2 | 792 | 924 | 973 | 1041 | 1094 | 1225 | 310 | 1202 ² | 96 | 204 | 58 ³ |
| 24 X 36RE | MRT, MRC | 2 | 792 | 924 | 973 | 1041 | 1094 | 1225 | 310 | 1202 ² | 96 | 204 | 63 ³ |
| 24 X 42RE | MRT, MRC | 2 | 857 | 1072 | 1128 | 1229 | 1290 | 1471 | 310 | 1202 ² | 96 | 204 | 66 ³ |
| 24 X 48RE | MRT, MRC | 2 | 857 | 1072 | 1128 | 1229 | 1290 | 1471 | 310 | 1202 ² | 96 | 204 | 71 ³ |
| 24 X 54RE | MRT, MRC | 2 | 918 | 1231 | 1301 | 1417 | 1504 | 1726 | 310 | 1202 ² | 96 | 204 | 74 ³ |
| 24 X 60RE | MRT, MRC | 2 | 918 | 1231 | 1301 | 1417 | 1504 | 1726 | 310 | 1202 ² | 96 | 204 | 79 ³ |
| 24 X 66RE | MRT, MRC | 2 | 1066 | 1443 | 1529 | 1671 | 1762 | 2034 | 310 | 1202 ² | 96 | 204 | 83 ³ |
| 24 X 72RE | MRT, MRC | 2 | 1066 | 1443 | 1529 | 1671 | 1762 | 2034 | 310 | 1202² | 96 | 204 | 88 ³ |

¹ Exposed Baltic Birch plywood edge (PKNR, PF) can only be specified on square tops up to 47-1/2" x 95-1/2". Clear finish only.
² Electric Height Adjustable available with T-base in Silver or Black only. Optional casters can be added. Flip top, fold options not available. 18" height range from 24" to 42" on a table with leveling glides, and from 26" to 44" on tables specified with casters. Electrical cord is 11ft long.
³ For Electric Height Adjustable table add 18 lbs per table.



STANDARD FEATURES

- Select from 15 standard laminates or choose any standard Wilsonart, Nevamar, Formica, Arborite and Pionite matte finish laminates at no upcharge. For other laminate please contact the factory for pricing.
- 9 standard veneer and hardwood edge stains. Stain-to-match available at no upcharge.
- Standard with leveling glides.
- Bases for electric height adjustable tables available in silver or black. Bases for all other tables available in any Spectone color.
- Standard 29" table height.
- Locking Casters are not self-leveling.
- Base span increases with size of top.

OPTIONS

- For other table accessories, including modesty panels or applicable Power & Data modules, please see Table Accessories Price List.

HOW TO ORDER

1. Select Model
2. Select Base
3. Select Edge Style
4. Select Options
5. Select Top Finish
6. Select Edge Finish
7. Select Base Finish





BACK TO CONTENTS

MANHATTAN TABLES - RECTANGLE COLUMN GENERAL PURPOSE

| MODEL | BASES | | TOP SPECIFICATIONS | | | | | | OPTIONS | | MOBILITY | | LBS |
|------------------|----------|------|--------------------|--|--------------------|-------------------------------------|--------------------------------|-------------------------------------|---------------|-------------------|-------------------|------------|------------------|
| | Code | Qty. | For Laminate Top | | | For Veneer Top | | | FLIP TOP (FT) | ELECTRIC HEIGHT | CASTERS HARD (HC) | SOFT (SC) | |
| | | | SE PVF 2MM | HF HB PKNR ¹ PF ¹ | HBV HBVR HBG | HF2 HB2 HKN4 HKNR4 HBG2 | HF HB HBV HBVR HBG | HF2 HB2 HKN4 HKNR4 HBG2 | | | | | |
| <i>Rectangle</i> | | | | | | | | | | | | | |
| 30 X 36RE | MRT, MRC | 2 | 886 | 1041 | 1095 | 1184 | 1246 | 1404 | 310 | 1202 ² | 96 | 204 | 64 ³ |
| 30 X 42RE | MRT, MRC | 2 | 908 | 1202 | 1269 | 1385 | 1471 | 1691 | 310 | 1202 ² | 96 | 204 | 74 ³ |
| 30 X 48RE | MRT, MRC | 2 | 908 | 1202 | 1269 | 1385 | 1471 | 1691 | 310 | 1202 ² | 96 | 204 | 79 ³ |
| 30 X 54RE | MRT, MRC | 2 | 969 | 1369 | 1456 | 1622 | 1720 | 1996 | 310 | 1202 ² | 96 | 204 | 85 ³ |
| 30 X 60RE | MRT, MRC | 2 | 969 | 1369 | 1456 | 1622 | 1720 | 1996 | 310 | 1202 ² | 96 | 204 | 90 ³ |
| 30 X 66RE | MRT, MRC | 2 | 1145 | 1470 | 1576 | 1743 | 1839 | 2144 | 310 | 1202 ² | 96 | 204 | 95 ³ |
| 30 X 72RE | MRT, MRC | 2 | 1203 | 1626 | 1733 | 1949 | 2062 | 2398 | 310 | 1202 ² | 96 | 204 | 100 ³ |
| 30 X 78RE | MRT, MRC | 2 | 1431 | 1806 | 1933 | 2184 | 2316 | 2702 | 310 | | 96 | 204 | 106 |
| 30 X 84RE | MRT, MRC | 2 | 1431 | 1806 | 1933 | 2184 | 2316 | 2702 | 310 | | 96 | 204 | 111 |
| 30 X 90RE | MRT, MRC | 2 | 1453 | 2031 | 2184 | 2416 | 2572 | 3012 | 310 | | 96 | 204 | 116 |
| 30 X 96RE | MRT, MRC | 2 | 1453 | 2031 | 2184 | 2416 | 2572 | 3012 | 310 | | 96 | 204 | 121 |

¹ Exposed Baltic Birch plywood edge (PKNR, PF) can only be specified on square tops up to 47-1/2" x 95-1/2". Clear finish only.
² Electric Height Adjustable available with T-base in Silver or Black only. Optional casters can be added. Flip top, fold options not available. 18" height range from 24" to 42" on a table with leveling glides, and from 26" to 44" on tables specified with casters. Electrical cord is 11ft long.
³ For Electric Height Adjustable table add 18 lbs per table.



MRT



MRC



ELECTRIC HEIGHT ADJUSTABLE



HEIGHT ADJUSTMENT BUTTON
Control push button can be mounted left or right.

STANDARD FEATURES

- Select from 15 standard laminates or choose any standard Wilsonart, Nevamar, Formica, Arborite and Pionite matte finish laminates at no upcharge. For other laminate please contact the factory for pricing.
- 9 standard veneer and hardwood edge stains. Stain-to-match available at no upcharge.
- Standard with leveling glides.
- Bases for electric height adjustable tables available in silver or black. Bases for all other tables available in any Spectone color.
- Standard 29" table height.
- Locking Casters are not self-leveling.
- Base span increases with size of top.

OPTIONS

- For other table accessories, including modesty panels or applicable Power & Data modules, please see Table Accessories Price List.

HOW TO ORDER

1. Select Model
2. Select Base
3. Select Edge Style
4. Select Options
5. Select Top Finish
6. Select Edge Finish
7. Select Base Finish

Example: 3060RE - MRT - PVF -
 MODEL BASE EDGE OPTIONS



BACK TO CONTENTS

MANHATTAN TABLES - RECTANGLE COLUMN

GENERAL PURPOSE

| MODEL | BASES | | TOP SPECIFICATIONS | | | | | | OPTIONS | | MOBILITY | | LBS |
|------------------|----------|------|--------------------|--|--------------------|-------------------------------------|--------------------------------|-------------------------------------|---------------|-------------------|-------------------|------------|------------------|
| | Code | Qty. | For Laminate Top | | | For Veneer Top | | | FLIP TOP (FT) | ELECTRIC HEIGHT | CASTERS HARD (HC) | SOFT (SC) | |
| | | | SE PVF 2MM | HF HB PKNR ¹ PF ¹ | HBV HBVR HBG | HF2 HB2 HKN4 HKNR4 HBG2 | HF HB HBV HBVR HBG | HF2 HB2 HKN4 HKNR4 HBG2 | | | | | |
| <i>Rectangle</i> | | | | | | | | | | | | | |
| 36 X 42RE | MRT, MRC | 2 | 1010 | 1231 | 1315 | 1430 | 1520 | 1751 | 310 | 1202 ² | 96 | 204 | 88 ² |
| 36 X 48RE | MRT, MRC | 2 | 1035 | 1347 | 1438 | 1576 | 1667 | 1938 | 310 | 1202 ² | 96 | 204 | 88 ² |
| 36 X 54RE | MRT, MRC | 2 | 1115 | 1452 | 1556 | 1710 | 1826 | 2122 | 310 | 1202 ² | 96 | 204 | 90 ² |
| 36 X 60RE | MRT, MRC | 2 | 1134 | 1568 | 1678 | 1854 | 1965 | 2303 | 310 | 1202 ² | 96 | 204 | 95 ² |
| 36 X 66RE | MRT, MRC | 2 | 1224 | 1674 | 1801 | 1994 | 2116 | 2487 | 310 | 1202 ² | 96 | 204 | 94 ² |
| 36 X 66RE | MRT2 | 2 | 1590 | 2040 | 2167 | 2360 | 2482 | 2853 | 310 | | 96 | 204 | 108 |
| 36 X 72RE | MRT | 2 | 1263 | 1733 | 1854 | 2133 | 2269 | 2670 | 310 | 1202 ² | 96 | 204 | 107 ² |
| 36 X 72RE | MRT2 | 2 | 1629 | 2099 | 2220 | 2499 | 2635 | 3036 | | | 96 | 204 | 115 |
| 36 X 78RE | MRT | 2 | 1604 | 2107 | 2265 | 2508 | 2666 | 3139 | 310 | | 96 | 204 | 114 |
| 36 X 78RE | MRT2 | 2 | 1970 | 2473 | 2631 | 2874 | 3032 | 3505 | | | 96 | 204 | 121 |
| 36 X 84RE | MRT | 2 | 1604 | 2107 | 2265 | 2508 | 2666 | 3139 | 310 | | 96 | 204 | 120 |
| 36 X 84RE | MRT2 | 2 | 1970 | 2473 | 2631 | 2874 | 3032 | 3505 | | | 96 | 204 | 127 |
| 36 X 90RE | MRT | 2 | 1611 | 2328 | 2508 | 2791 | 2973 | 3497 | 310 | | 96 | 204 | 126 |
| 36 X 90RE | MRT2 | 2 | 1977 | 2694 | 2874 | 3157 | 3339 | 3863 | | | 96 | 204 | 133 |
| 36 X 96RE | MRT | 2 | 1611 | 2328 | 2508 | 2791 | 2973 | 3497 | 310 | | 96 | 204 | 132 |
| 36 X 96RE | MRT2 | 2 | 1977 | 2694 | 2874 | 3157 | 3339 | 3863 | | | 96 | 204 | 135 |
| 42 X 78RE | MRT2 | 2 | 2218 | 2650 | 2823 | 3241 | 3378 | 3926 | | | 96 | 204 | 143 |
| 42 X 84RE | MRT2 | 2 | 2218 | 2650 | 2823 | 3241 | 3378 | 3926 | | | 96 | 204 | 148 |

¹ Exposed Baltic Birch plywood edge (PKNR, PF) can only be specified on square tops up to 47-1/2" x 95-1/2". Clear finish only.
² Electric Height Adjustable available with T-base in Silver or Black only. Optional casters can be added. Flip top, fold options not available. 18" height range from 24" to 42" on a table with leveling glides, and from 26" to 44" on tables specified with casters. Electrical cord is 11ft long.
³ For Electric Height Adjustable table add 18 lbs per table.



STANDARD FEATURES

- Select from 15 standard laminates or choose any standard Wilsonart, Nevamar, Formica, Arborite and Pionite matte finish laminates at no upcharge. For other laminate please contact the factory for pricing.
- 9 standard veneer and hardwood edge stains. Stain-to-match available at no upcharge.
- Standard with leveling glides.
- Bases for electric height adjustable tables available in silver or black. Bases for all other tables available in any Spectone color.
- Standard 29" table height.
- Locking Casters are not self-leveling.
- Base span increases with size of top.

OPTIONS

- For other table accessories, including modesty panels or applicable Power & Data modules, please see Table Accessories Price List.

HOW TO ORDER

1. Select Model
2. Select Base
3. Select Edge Style
4. Select Options
5. Select Top Finish
6. Select Edge Finish
7. Select Base Finish

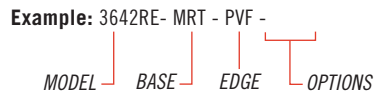



BACK TO CONTENTS

MANHATTAN TABLES - RECTANGLE COLUMN GENERAL PURPOSE



| MODEL | BASES | | TOP SPECIFICATIONS | | | | | | OPTIONS | MOBILITY | | LBS |
|------------------|-------|------|--------------------|-------|--------------|--------------------|--------------------|--------------------|---------|---------------|-------------------|-----|
| | Code | Qty. | For Laminate Top | | | For Veneer Top | | | | FLIP TOP (FT) | CASTERS HARD (HC) | |
| | | | SE PVF 2MM | HF HB | HBV HBVR HBG | HF2 HB2 HKNR4 HBG2 | HF HB HBV HBVR HBG | HF2 HB2 HKNR4 HBG2 | | | | |
| <i>Racetrack</i> | | | | | | | | | | | | |
| 36 X 54RT | MRT | 2 | 1191 | 1762 | 1895 | 2133 | 2231 | 2580 | 310 | 96 | 204 | 84 |
| 36 X 54RT | MRT2 | 2 | 1557 | 2128 | 2261 | 2499 | 2597 | 2946 | | 96 | 204 | 90 |
| 36 X 60RT | MRT | 2 | 1191 | 1762 | 1895 | 2133 | 2231 | 2580 | 310 | 96 | 204 | 89 |
| 36 X 60RT | MRT2 | 2 | 1557 | 2128 | 2261 | 2499 | 2597 | 2946 | | 96 | 204 | 95 |
| 36 X 66RT | MRT | 2 | 1352 | 1949 | 2093 | 2348 | 2572 | 3008 | 310 | 96 | 204 | 94 |
| 36 X 66RT | MRT2 | 2 | 1718 | 2315 | 2459 | 2714 | 2938 | 3374 | | 96 | 204 | 108 |
| 36 X 72RT | MRT | 2 | 1352 | 1949 | 2093 | 2348 | 2572 | 3008 | 310 | 96 | 204 | 107 |
| 36 X 72RT | MRT2 | 2 | 1718 | 2315 | 2459 | 2714 | 2938 | 3374 | | 96 | 204 | 115 |
| 36 X 78RT | MRT | 2 | 1622 | 2380 | 2557 | 2942 | 3023 | 3531 | 310 | 96 | 204 | 114 |
| 36 X 78RT | MRT2 | 2 | 1988 | 2746 | 2923 | 3308 | 3389 | 3897 | | 96 | 204 | 121 |
| 36 X 84RT | MRT | 2 | 1622 | 2380 | 2557 | 2942 | 3023 | 3531 | 310 | 96 | 204 | 120 |
| 36 X 84RT | MRT2 | 2 | 1988 | 2746 | 2923 | 3308 | 3389 | 3897 | | 96 | 204 | 127 |
| 36 X 90RT | MRT | 2 | 1626 | 2637 | 2848 | 3279 | 3380 | 3959 | 310 | 96 | 204 | 130 |
| 36 X 90RT | MRT2 | 2 | 1992 | 3003 | 3214 | 3645 | 3746 | 4325 | | 96 | 204 | 133 |
| 36 X 96RT | MRT | 2 | 1626 | 2637 | 2848 | 3279 | 3380 | 3959 | 310 | 96 | 204 | 130 |
| 36 X 96RT | MRT2 | 2 | 1992 | 3003 | 3214 | 3645 | 3746 | 4325 | | 96 | 204 | 135 |
| 42 X 78RT | MRT2 | 2 | 2233 | 2950 | 3167 | 3603 | 3708 | 4292 | | 96 | 204 | 143 |
| 42 X 84RT | MRT2 | 2 | 2233 | 2950 | 3167 | 3603 | 3708 | 4292 | | 96 | 204 | 148 |
| 48 X 78RT | MRT2 | 2 | 2236 | 3258 | 3504 | 3890 | 4131 | 4795 | | 96 | 204 | 143 |
| 48 X 84RT | MRT2 | 2 | 2236 | 3258 | 3504 | 3890 | 4131 | 4795 | | 96 | 204 | 148 |



MRT



MRT2

STANDARD FEATURES

- Select from 15 standard laminates or choose any standard Wilsonart, Nevamar, Formica, Arborite and Pionite matte finish laminates at no upcharge. For other laminate please contact the factory for pricing.
- 9 standard veneer and hardwood edge stains. Stain-to-match available at no upcharge.
- Standard with leveling glides.
- Bases available in any Spectone color.
- Standard 29" table height.
- Locking Casters are not self-leveling.
- Base span increases with size of top.

OPTIONS

- For other table accessories, including modesty panels or applicable Power & Data modules, please see Table Accessories Price List.

HOW TO ORDER

1. Select Model
2. Select Base
3. Select Edge Style
4. Select Options
5. Select Top Finish
6. Select Edge Finish
7. Select Base Finish

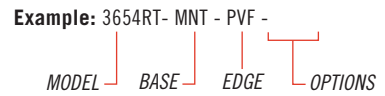



BACK TO CONTENTS

MANHATTAN TABLES - RECTANGLE COLUMN GENERAL PURPOSE



| MODEL | BASES | | TOP SPECIFICATIONS | | | | | | OPTIONS | MOBILITY | | LBS |
|------------------|-------|------|--------------------|-------|--------------|--------------------|--------------------|--------------------|---------|---------------|-------------------|-----|
| | Code | Qty. | For Laminate Top | | | For Veneer Top | | | | FLIP TOP (FT) | CASTERS HARD (HC) | |
| | | | SE PVF 2MM | HF HB | HBV HBVR HBG | HF2 HB2 HKNR4 HBG2 | HF HB HBV HBVR HBG | HF2 HB2 HKNR4 HBG2 | | | | |
| <i>Bullet</i> | | | | | | | | | | | | |
| 30 X 54B | MRT | 2 | 1090 | 1659 | 1778 | 1986 | 2048 | 2392 | 310 | 96 | 204 | 85 |
| 30 X 60B | MRT | 2 | 1090 | 1659 | 1778 | 1986 | 2048 | 2392 | 310 | 96 | 204 | 90 |
| 36 X 54B | MRT | 2 | 1213 | 2170 | 2339 | 2644 | 2686 | 3119 | 310 | 96 | 204 | 90 |
| 36 X 60B | MRT | 2 | 1213 | 2170 | 2339 | 2644 | 2686 | 3119 | 310 | 96 | 204 | 95 |
| 36 X 66B | MRT | 2 | 1351 | 2409 | 2596 | 2922 | 3111 | 3655 | 310 | 96 | 204 | 108 |
| 36 X 72B | MRT | 2 | 1351 | 2409 | 2596 | 2922 | 3111 | 3655 | 310 | 96 | 204 | 115 |
| <i>Halfmoon</i> | | | | | | | | | | | | |
| 24 X 48H | MRT | 2 | 875 | 1389 | 1518 | 1674 | 1801 | 2093 | 310 | 96 | 204 | 71 |
| 30 X 60H | MRT | 2 | 1090 | 1855 | 2032 | 2208 | 2428 | 2845 | 310 | 96 | 204 | 90 |
| 36 X 72H | MRT | 2 | 1351 | 2395 | 2626 | 2842 | 3199 | 3763 | 310 | 96 | 204 | 115 |
| <i>Trapezoid</i> | | | | | | | | | | | | |
| 30 X 60TP | MRT | 2 | 1090 | 1561 | 1671 | 1860 | 1915 | 2234 | 310 | 96 | 204 | 90 |
| 36 X 72TP | MRT | 2 | 1351 | 1990 | 2134 | 2462 | 2544 | 3004 | 310 | 96 | 204 | 115 |
| <i>Crescent</i> | | | | | | | | | | | | |
| 30 X 36RC90 | MRT | 2 | 1065 | 1751 | 1838 | 1906 | 2124 | 2363 | | 96 | 204 | 48 |
| 36 X 42RC90 | MRT | 2 | 1428 | 2072 | 2191 | 2280 | 2580 | 2904 | | 96 | 204 | 61 |



MRT

STANDARD FEATURES

- Select from 15 standard laminates or choose any standard Wilsonart, Nevamar, Formica, Arborite and Pionite matte finish laminates at no upcharge. For other laminate please contact the factory for pricing.
- 9 standard veneer and hardwood edge stains. Stain-to-match available at no upcharge.
- Standard with leveling glides.
- Bases available in any Spectone color.
- Standard 29" table height.
- Locking Casters are not self-leveling.
- Base span increases with size of top.

OPTIONS

- For other table accessories, including modesty panels or applicable Power & Data modules, please see Table Accessories Price List.

HOW TO ORDER

1. Select Model
2. Select Base
3. Select Edge Style
4. Select Options
5. Select Top Finish
6. Select Edge Finish
7. Select Base Finish





MANHATTAN TABLES - RECTANGLE COLUMN BOARDROOM



| MODEL | BASES | | TOP SPECIFICATIONS | | | | | | OPTIONS | LBS |
|------------------|-------|------|--------------------|--|--------------------|--------------------------------------|--------------------------------|--------------------------------------|---------|-----|
| | Code | Qty. | For Laminate Top | | | For Veneer Top | | | | |
| | | | SE PVF 2MM | HF HB PKNR ¹ PF ¹ | HBV HBVR HBG | HF2 HB2 HKNR4 HKNR4 HBG2 | HF HB HBV HBVR HBG | HF2 HB2 HKNR4 HKNR4 HBG2 | | |
| <i>Rectangle</i> | | | | | | | | | | |
| 42 X 96RE | MRT2 | 2 | 2271 | 3181 | 3427 | 3676 | 4044 | 4756 | | 175 |
| 48 X 96RE | MRT2 | 2 | 2271 | 3181 | 3427 | 3676 | 4044 | 4756 | | 179 |
| 48 X 120RE | MRT2 | 3 | 3035 | 4210 | 4488 | 5089 | 5177 | 6010 | | 228 |
| 48 X 144RE | MRT2 | 3 | 3431 | 5116 | 5483 | 6054 | 5918 | 6920 | | 262 |
| 48 X 168RE | MRT2 | 3 | 3935 | 5631 | 6050 | 6847 | 6663 | 7827 | | 296 |
| 60 X 120RE | MRT2 | 3 | 3519 | 5276 | 5660 | 6252 | 6111 | 7156 | | 270 |
| 60 X 144RE | MRT2 | 3 | 3967 | 6076 | 6535 | 7246 | 7078 | 8331 | | 312 |
| 60 X 168RE | MRT2 | 3 | 4417 | 6876 | 7410 | 8242 | 8045 | 9505 | | 354 |
| <i>Racetrack</i> | | | | | | | | | | |
| 42 X 96RT | MRT2 | 2 | 2291 | 3320 | 3571 | 4174 | 4600 | 5359 | | 175 |
| 48 X 96RT | MRT2 | 2 | 2291 | 3320 | 3571 | 4174 | 4600 | 5359 | | 179 |
| 48 X 120RT | MRT2 | 3 | 3062 | 4694 | 5021 | 5852 | 5817 | 6704 | | 228 |
| 48 X 144RT | MRT2 | 3 | 3461 | 5494 | 5895 | 6925 | 6686 | 7762 | | 262 |
| 48 X 168RT | MRT2 | 3 | 3967 | 6178 | 6646 | 7790 | 7568 | 8815 | | 296 |
| 60 X 120RT | MRT2 | 3 | 3508 | 5548 | 5954 | 6998 | 6951 | 8064 | | 270 |
| 60 X 144RT | MRT2 | 3 | 4007 | 6548 | 7051 | 8341 | 8040 | 9384 | | 312 |
| 60 X 168RT | MRT2 | 3 | 4642 | 7407 | 7991 | 9417 | 9141 | 10699 | | 354 |

¹ Exposed Baltic Birch plywood edge (PKNR, PF) can only be specified on rectangle tops up to 47-1/2" x 95-1/2". Clear finish only.



MRT2

STANDARD FEATURES

- Select from 15 standard laminates or choose any standard Wilsonart, Nevamar, Formica, Arborite and Pionite matte finish laminates at no upcharge. For other laminate please contact the factory for pricing.
- 9 standard veneer and hardwood edge stains. Stain-to-match available at no upcharge.
- Standard with leveling glides.
- Bases available in any Spectone color.
- Standard 29" table height.
- Locking Casters are not self-leveling.
- Base span increases with size of top.

OPTIONS

- For other table accessories, including modesty panels or applicable Power & Data modules, please see Table Accessories Price List.

HOW TO ORDER

1. Select Model
2. Select Base
3. Select Edge Style
4. Select Options
5. Select Top Finish
6. Select Edge Finish
7. Select Base Finish

Example: 4296RE - MNT2 - PVF -





MANHATTAN TABLES - RECTANGLE COLUMN BOARDROOM



| MODEL | BASES | | TOP SPECIFICATIONS | | | | | | OPTIONS | LBS |
|------------------|-------|------|--------------------|----------|--------------------|--------------------------------------|--------------------------------|--------------------------------------|---------|-----|
| | Code | Qty. | For Laminate Top | | | For Veneer Top | | | | |
| | | | SE PVF 2MM | HF HB | HBV HBVR HBG | HF2 HB2 HKNR4 HKNR4 HBG2 | HF HB HBV HBVR HBG | HF2 HB2 HKNR4 HKNR4 HBG2 | | |
| <i>Boatshape</i> | | | | | | | | | | |
| 42 X 96BT | MRT2 | 2 | 2291 | 4022 | 4344 | 4676 | 5147 | 5561 | | 175 |
| 48 X 96BT | MRT2 | 2 | 2291 | 4022 | 4344 | 4676 | 5147 | 5561 | | 179 |
| 48 X 120BT | MRT2 | 3 | 3062 | 5463 | 5862 | 6284 | 6463 | 6942 | | 228 |
| 48 X 144BT | MRT2 | 3 | 3461 | 6264 | 6740 | 7246 | 7884 | 8319 | | 262 |
| 48 X 168BT | MRT2 | 3 | 3967 | 7029 | 7584 | 8168 | 8466 | 9138 | | 296 |
| 60 X 120 BT | MRT2 | 3 | 3508 | 6507 | 7010 | 7536 | 7762 | 8356 | | 270 |
| 60 X 144BT | MRT2 | 3 | 4007 | 7512 | 8107 | 8740 | 9535 | 10081 | | 312 |
| 60 X 168BT | MRT2 | 3 | 4642 | 8470 | 9161 | 9892 | 10262 | 11104 | | 354 |
| <i>Boat Arc</i> | | | | | | | | | | |
| 42 X 96BTA | MRT2 | 2 | 2467 | 4573 | 4897 | 5231 | 5699 | 6113 | | 175 |
| 48 X 96BTA | MRT2 | 2 | 2467 | 4573 | 4897 | 5231 | 5699 | 6113 | | 179 |
| 48 X 120BTA | MRT2 | 3 | 3237 | 6017 | 6417 | 6839 | 7018 | 7493 | | 228 |
| 48 X 144BTA | MRT2 | 3 | 3637 | 6815 | 7295 | 7801 | 8435 | 8873 | | 262 |
| 48 X 168BTA | MRT2 | 3 | 4144 | 7584 | 8139 | 8723 | 9019 | 9694 | | 296 |
| 60 X 120BTA | MRT2 | 3 | 3729 | 7202 | 7701 | 8228 | 8452 | 9047 | | 270 |
| 60 X 144BTA | MRT2 | 3 | 4226 | 8201 | 8800 | 9431 | 10227 | 10770 | | 312 |
| 60 X 168BTA | MRT2 | 3 | 4861 | 9161 | 9853 | 10582 | 10955 | 11799 | | 354 |



MRT2

STANDARD FEATURES

- Select from 15 standard laminates or choose any standard Wilsonart, Nevamar, Formica, Arborite and Pionite matte finish laminates at no upcharge. For other laminate please contact the factory for pricing.
- 9 standard veneer and hardwood edge stains. Stain-to-match available at no upcharge.
- Standard with leveling glides.
- Bases available in any Spectone color.
- Standard 29" table height.
- Locking Casters are not self-leveling.
- Base span increases with size of top.

OPTIONS

- For other table accessories, including modesty panels or applicable Power & Data modules, please see Table Accessories Price List.

HOW TO ORDER

1. Select Model
2. Select Base
3. Select Edge Style
4. Select Options
5. Select Top Finish
6. Select Edge Finish
7. Select Base Finish

Example: 4296BT - MNT2 - PVF -





MANHATTAN TABLES - WITH FOOTRING - FREESTANDING GENERAL PURPOSE

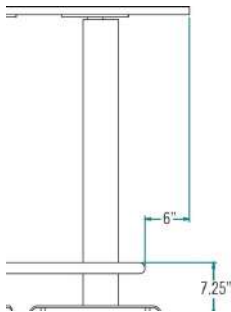

Footring location.

| MODEL | BASES | | TOP SPECIFICATIONS | | | | | | LBS |
|-------------------|--------------------------------------|------|--------------------|--|--------------------|-------------------------------------|--------------------------------|-------------------------------------|-----|
| | Code | Qty. | For Laminate Top | | | For Veneer Top | | | |
| | | | SE PVF 2MM | HF HB PKNR ¹ PF ¹ | HBV HBVR HBG | HF2 HB2 HKN4 HKNR4 HBG2 | HF HB HBV HBVR HBG | HF2 HB2 HKN4 HKNR4 HBG2 | |
| <i>Round</i> | | | | | | | | | |
| 48D | 48D-MNTRVWM-FR² | 3 | 3451 | 4224 | 4359 | 4491 | 4965 | 5367 | 124 |
| 60D | 60D-MNTRVWM-FR² | 3 | 3789 | 5083 | 5307 | 5476 | 6162 | 6803 | 176 |
| <i>Rectangle</i> | | | | | | | | | |
| 48 X 66RE | 4866RE-MNTRVWM-FR | 4 | 4701 | 5343 | 5514 | 5898 | 5960 | 6465 | 187 |
| 48 X 72RE | 4872RE-MNTRVWM-FR | 4 | 4744 | 5412 | 5591 | 5992 | 6057 | 6582 | 196 |
| 48 X 84RE | 4884RE-MNTRVWM-FR² | 4 | 5030 | 5713 | 5923 | 6332 | 6454 | 7079 | 213 |
| 48 X 96RE | 4896RE-MNTRVWM-FR² | 4 | 5082 | 5992 | 6238 | 6487 | 6855 | 7567 | 274 |
| 60 X 66RE | 6066RE-MNTRVWM-FR | 4 | 5030 | 5713 | 5923 | 6332 | 6454 | 7079 | 210 |
| 60 X 72RE | 6072RE-MNTRVWM-FR | 4 | 5082 | 5992 | 6238 | 6487 | 6855 | 7567 | 221 |
| 60 X 84RE | 6084RE-MNTRVWM-FR² | 4 | 5295 | 6340 | 6625 | 6909 | 7335 | 8155 | 242 |
| 60 X 96RE | 6096RE-MNTRVWM-FR² | 4 | 5420 | 6595 | 6873 | 7474 | 7562 | 8395 | 307 |
| <i>Racetrack</i> | | | | | | | | | |
| 48 X 72RT | 4872RT-MNTRVWM-FR | 4 | 4952 | 5915 | 6124 | 6458 | 6660 | 7238 | 180 |
| 48 X 84RT | 4884RT-MNTRVWM-FR² | 4 | 5239 | 6261 | 6507 | 6893 | 7134 | 7798 | 197 |
| 48 X 96RT | 4896RT-MNTRVWM-FR² | 4 | 5294 | 6323 | 6574 | 7177 | 7603 | 8362 | 258 |
| 48 X 120RT | 48120RT-MNTRVWM-FR | 6 | 6901 | 8533 | 8860 | 9691 | 9656 | 10543 | 293 |
| 60 X 72RT | 6072RT-MNTRVWM-FR | 4 | 5294 | 6323 | 6574 | 7177 | 7603 | 8362 | 197 |
| 60 X 84RT | 6084RT-MNTRVWM-FR² | 4 | 5438 | 6571 | 6846 | 7509 | 7977 | 8813 | 218 |
| 60 X 96RT | 6096RT-MNTRVWM-FR² | 4 | 5639 | 7271 | 7598 | 8429 | 8394 | 9281 | 283 |
| 60 X 120RT | 60120RT-MNTRVWM-FR | 6 | 7347 | 9387 | 9793 | 10837 | 10790 | 11903 | 325 |

¹ Exposed Baltic Birch plywood edge (PKNR, PF) can only be specified on rectangle tops up to 47-1/2" x 95-1/2". Clear finish only.

² Features an extra footring support.

STANDARD FEATURES

- Select from 15 standard laminates or choose any standard Wilsonart, Nevamar, Formica, Arborite and Pionite matte finish laminates at no upcharge. For other laminate please contact the factory for pricing.
- 9 standard veneer and hardwood edge stains. Stain-to-match available at no upcharge.
- For applicable Power & Data modules, please see Table Accessories Price List.
- Standard with leveling glides.
- Base available in any Spectone color.
- Standard 42" table height.
- Footring is inset 6" from table edge, and available in chrome only.
- Rectangular vertical wire manager comes standard on all table legs.

HOW TO ORDER

1. Select Model
2. Select Edge Style
3. Select Top Finish
4. Select Edge Finish
5. Select Base Finish

Example: 6066RE - MRTFR - PVF





MANHATTAN TABLES - WITH FOOTRING - WALL ADJACENT GENERAL PURPOSE



Shown with optional power module.

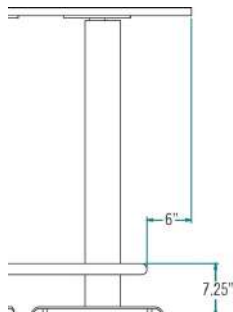

Footring location.

| MODEL | BASES | | TOP SPECIFICATIONS | | | | | | LBS |
|------------------|----------------------------------|------|--------------------|--|--------------------|-------------------------------------|--------------------------------|-------------------------------------|-----|
| | Code | Qty. | For Laminate Top | | | For Veneer Top | | | |
| | | | SE PVF 2MM | HF HB PKNR ¹ PF ¹ | HBV HBVR HBG | HF2 HB2 HKN4 HKNR4 HBG2 | HF HB HBV HBVR HBG | HF2 HB2 HKN4 HKNR4 HBG2 | |
| <i>Rectangle</i> | | | | | | | | | |
| 48 X 66RE | 4866RE-MNTRVWM-FRWA | 4 | 4306 | 4948 | 5119 | 5503 | 5565 | 6070 | 184 |
| 48 X 72RE | 4872RE-MNTRVWM-FRWA | 4 | 4349 | 5017 | 5196 | 5597 | 5662 | 6187 | 193 |
| 48 X 84RE | 4884RE-MNTRVWM-FRWA ² | 4 | 4635 | 5318 | 5528 | 5937 | 6059 | 6684 | 210 |
| 48 X 96RE | 4896RE-MNTRVWM-FRWA ² | 4 | 4687 | 5597 | 5843 | 6092 | 6460 | 7172 | 271 |
| 60 X 66RE | 6066RE-MNTRVWM-FRWA | 4 | 4635 | 5318 | 5528 | 5937 | 6059 | 6684 | 206 |
| 60 X 72RE | 6072RE-MNTRVWM-FRWA | 4 | 4687 | 5597 | 5843 | 6092 | 6460 | 7172 | 217 |
| 60 X 84RE | 6084RE-MNTRVWM-FRWA ² | 4 | 4900 | 5945 | 6230 | 6514 | 6940 | 7760 | 238 |
| 60 X 96RE | 6096RE-MNTRVWM-FRWA ² | 4 | 5025 | 6200 | 6478 | 7079 | 7167 | 8000 | 302 |
| <i>Bullet</i> | | | | | | | | | |
| 42 X 66B | 4266B-MNTRVWM-FRWA | 4 | 4551 | 5180 | 5406 | 5707 | 5784 | 6287 | 167 |
| 42 X 72B | 4272B-MNTRVWM-FRWA | 4 | 4686 | 5383 | 5635 | 5971 | 6055 | 6615 | 175 |
| 42 X 84B | 4284B-MNTRVWM-FRWA ² | 4 | 4795 | 5557 | 5833 | 6197 | 6288 | 6899 | 190 |
| 42 X 96B | 4296B-MNTRVWM-FRWA ² | 4 | 5014 | 5903 | 6224 | 6650 | 6756 | 7467 | 249 |
| 48 X 66B | 4866B-MNTRVWM-FRWA | 4 | 4686 | 5383 | 5635 | 5971 | 6055 | 6615 | 176 |
| 48 X 72B | 4872B-MNTRVWM-FRWA | 4 | 4795 | 5557 | 5833 | 6197 | 6288 | 6899 | 185 |
| 48 X 84B | 4884B-MNTRVWM-FRWA ² | 4 | 5014 | 5903 | 6224 | 6650 | 6756 | 7467 | 202 |
| 48 X 96B | 4896B-MNTRVWM-FRWA ² | 4 | 5233 | 6248 | 6615 | 7102 | 7224 | 8036 | 263 |
| 60 X 66B | 6066B-MNTRVWM-FRWA | 4 | 4860 | 5661 | 5950 | 6335 | 6429 | 7070 | 194 |
| 60 X 72B | 6072B-MNTRVWM-FRWA | 4 | 4985 | 5859 | 6174 | 6592 | 6697 | 7396 | 205 |
| 60 X 84B | 6084B-MNTRVWM-FRWA ² | 4 | 5237 | 6255 | 6622 | 7112 | 7234 | 8048 | 226 |
| 60 X 96B | 6096B-MNTRVWM-FRWA ² | 4 | 5485 | 6651 | 7070 | 7629 | 7769 | 8701 | 290 |

¹ Exposed Baltic Birch plywood edge (PKNR, PF) can only be specified on rectangle tops up to 47-1/2" x 95-1/2". Clear finish only.

² Features an extra footring support.

STANDARD FEATURES

- Select from 15 standard laminates or choose any standard Wilsonart, Nevamar, Formica, Arborite and Pionite matte finish laminates at no upcharge. For other laminate please contact the factory for pricing.
- 9 standard veneer and hardwood edge stains. Stain-to-match available at no upcharge.
- For applicable Power & Data modules, please see Table Accessories Price List.
- Standard with leveling glides.
- Base available in any Spectone color.
- Standard 42" table height.
- Footring is inset 6" from table edge, and available in chrome only.
- Rectangular vertical wire manager comes standard on all table legs.

HOW TO ORDER

1. Select Model
2. Select Edge Style
3. Select Top Finish
4. Select Edge Finish
5. Select Base Finish

Example: 6066B - MRTFRWA - PVF





BACK TO CONTENTS

MANHATTAN TABLES - 29" HIGH, WITH 66"H MEDIA WALL

TABLETOP



| MODEL | TOP SPECIFICATIONS | | | | LBS |
|------------------|-------------------------|--|--------------------|-----------------------------|-----|
| | <i>For Laminate Top</i> | | | | |
| | SE PVF 2MM | HF HB PKNR ¹ PF ¹ | HBV HBVR HBG | HF2 HB2 HKNR4 HBG2 | |
| <i>Rectangle</i> | | | | | |
| 48 X 72RE | 1081 | 1749 | 1928 | 2329 | 86 |
| 48 X 84RE | 1367 | 2050 | 2260 | 2669 | 101 |
| 48 X 96RE | 1419 | 2329 | 2575 | 2824 | 115 |
| 54 X 72RE | 1419 | 2329 | 2575 | 2824 | 97 |
| 54 X 84RE | 1632 | 2677 | 2962 | 3246 | 113 |
| 54 X 96RE | 1757 | 2932 | 3210 | 3811 | 130 |
| 60 X 72RE | 1419 | 2329 | 2575 | 2824 | 108 |
| 60 X 84RE | 1632 | 2677 | 2962 | 3246 | 126 |
| 60 X 96RE | 1757 | 2932 | 3210 | 3811 | 144 |
| <i>Bullet</i> | | | | | |
| 48 X 72B | 1451 | 2213 | 2489 | 2853 | 73 |
| 48 X 84B | 1670 | 2559 | 2880 | 3306 | 86 |
| 48 X 96B | 1889 | 2904 | 3271 | 3758 | 98 |
| 54 X 72B | 1641 | 2515 | 2830 | 3248 | 83 |
| 54 X 84B | 1893 | 2911 | 3278 | 3768 | 96 |
| 54 X 96B | 2141 | 3307 | 3726 | 4285 | 110 |
| 60 X 72B | 1641 | 2515 | 2830 | 3248 | 92 |
| 60 X 84B | 1893 | 2911 | 3278 | 3768 | 107 |
| 60 X 96B | 2141 | 3307 | 3726 | 4285 | 122 |

¹ Exposed Baltic Birch plywood edge (PKNR, PF) can only be specified on rectangle tops up to 47-1/2" x 95-1/2". Clear finish only.



STANDARD FEATURES

- Media wall is standard with plinth support base.
- Only one Manhattan base is required when table is specified with media wall.
- Table top depth/width matches media wall width, unless specified otherwise.
- Select from 15 standard laminates or choose any standard Wilsonart, Nevamar, Formica, Arborite and Pionite matte finish laminates at no upcharge. For other laminate please contact the factory for pricing.
- 9 standard veneer and hardwood edge stains. Stain-to-match available at no upcharge.
- Standard with leveling glides.
- Bases available in any Spectone color.
- Does not ship with monitor or monitor bracket.

Toll Free: 1-888-761-7732

MEDIA WALL, 66" H

| MODEL | Qty. | Laminate SE 2MM | LBS |
|---------|------|-----------------|-----|
| MWP4866 | 1 | 5580 | 142 |
| MWP5466 | 1 | 5580 | 145 |
| MWP6066 | 1 | 5856 | 149 |

BASE

| MODEL | Qty. | LBS |
|-------------------|------|------------|
| MNT2 | 1 | 387 |
| MRT2 ² | 1 | 426 |

² MRT2 does not allow for wires to be channelled through column.



OVAL VERTICAL WIRE MANAGER (VWM)

RECTANGULAR VERTICAL WIRE MANAGER (RVWM)

OPTIONS

- Oval (VWM) or Rectangular (RVWM) vertical wire manager can be added to each column of the round (MNT2) Manhattan base only to neatly conceal and direct power to the floor. Add **\$187** List.
- For applicable Power & Data modules, please see Table Accessories Price List.

HOW TO ORDER

1. Select Top Size & Shape
2. Select Top Finish
3. Select Edge Style & Finish
4. Select Media Wall
5. Select Media Wall Finish
6. Select Base
7. Select Options
8. Select Base Finish

Example: 4896B - MW4866 - MNT2 -





MANHATTAN TABLES - 42" HIGH, WITH 78"H MEDIA WALL

TABLETOP



| MODEL | TOP SPECIFICATIONS | | | | LBS |
|------------------|-------------------------|--|--------------------|-----------------------------|-----|
| | <i>For Laminate Top</i> | | | | |
| | SE PVF 2MM | HF HB PKNR ¹ PF ¹ | HBV HBVR HBG | HF2 HB2 HKNR4 HBG2 | |
| <i>Rectangle</i> | | | | | |
| 48 X 72RE | 1081 | 1749 | 1928 | 2329 | 86 |
| 48 X 84RE | 1367 | 2050 | 2260 | 2669 | 101 |
| 48 X 96RE | 1419 | 2329 | 2575 | 2824 | 115 |
| 54 X 72RE | 1419 | 2329 | 2575 | 2824 | 97 |
| 54 X 84RE | 1632 | 2677 | 2962 | 3246 | 113 |
| 54 X 96RE | 1757 | 2932 | 3210 | 3811 | 130 |
| 60 X 72RE | 1419 | 2329 | 2575 | 2824 | 108 |
| 60 X 84RE | 1632 | 2677 | 2962 | 3246 | 126 |
| 60 X 96RE | 1757 | 2932 | 3210 | 3811 | 144 |
| <i>Bullet</i> | | | | | |
| 48 X 72B | 1451 | 2213 | 2489 | 2853 | 73 |
| 48 X 84B | 1670 | 2559 | 2880 | 3306 | 86 |
| 48 X 96B | 1889 | 2904 | 3271 | 3758 | 98 |
| 54 X 72B | 1641 | 2515 | 2830 | 3248 | 83 |
| 54 X 84B | 1893 | 2911 | 3278 | 3768 | 96 |
| 54 X 96B | 2141 | 3307 | 3726 | 4285 | 110 |
| 60 X 72B | 1641 | 2515 | 2830 | 3248 | 92 |
| 60 X 84B | 1893 | 2911 | 3278 | 3768 | 107 |
| 60 X 96B | 2141 | 3307 | 3726 | 4285 | 122 |

¹ Exposed Baltic Birch plywood edge (PKNR, PF) can only be specified on rectangle tops up to 47-1/2" x 95-1/2". Clear finish only.



STANDARD FEATURES

- Media wall is standard with plinth support base.
- Only one Manhattan base is required when table is specified with media wall.
- Table top depth/width matches media wall width, unless specified otherwise.
- Select from 15 standard laminates or choose any standard Wilsonart, Nevamar, Formica, Arborite and Pionite matte finish laminates at no upcharge. For other laminate please contact the factory for pricing.
- 9 standard veneer and hardwood edge stains. Stain-to-match available at no upcharge.
- Standard with leveling glides.
- Bases available in any Spectone color.
- Does not ship with monitor or monitor bracket.

Toll Free: 1-888-761-7732

MEDIA WALL, 78" H

| MODEL | Qty. | Laminate SE 2MM | LBS |
|---------|------|-----------------|-----|
| MWP4878 | 1 | 6407 | 147 |
| MWP5478 | 1 | 7512 | 151 |
| MWP6078 | 1 | 7512 | 155 |

BASE

| MODEL | Qty. | LBS |
|-------------------|------|------------|
| MNT2 | 1 | 387 |
| MRT2 ² | 1 | 426 |

² MRT2 does not allow for wires to be channelled through column.



OVAL VERTICAL WIRE MANAGER (VWM)

RECTANGULAR VERTICAL WIRE MANAGER (RVWM)

OPTIONS

- Oval (VWM) or Rectangular (RVWM) vertical wire manager can be added to each column of the round (MNT2) Manhattan base only to neatly conceal and direct power to the floor. Add **\$187** List.
- For applicable Power & Data modules, please see Table Accessories Price List.

HOW TO ORDER

1. Select Top Size & Shape
2. Select Top Finish
3. Select Edge Style & Finish
4. Select Media Wall
5. Select Media Wall Finish
6. Select Base
7. Select Options
8. Select Base Finish

Example: 4896B - MW4866 - MNT2 -



MIDWAY & COMPANION TABLES



MIDWAY



COMPANION

PRODUCT CODE

2448 RE - MIDWAY

Top Size

Width x Length or
Diameter

Top Shape

D : Round
SQ : Square
RE : Rectangle

Series

MIDWAY : Midway
COMPANION : Companion

FINISHES

LAMINATE



Select from 15 standard laminates or choose any standard Wilsonart, Nevamar, Formica, Arborite and Pionite matte finish laminates at no upcharge

VENEER



Select from one of our 9 standard wood stains or stain-to-match at no upcharge

BASE



Select from one of our 76 standard Spectone colors

EDGE



See Spectone Card or specfurniture.com/materials/finishes for a complete list of finish options and colors.

MIDWAY & COMPANION TABLES

HOW TO ORDER

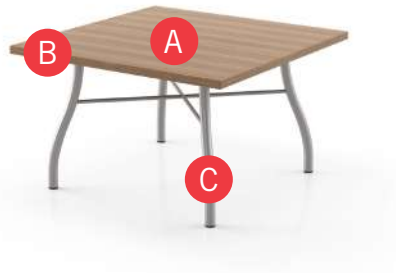

Specify Top Size (Width x Length) and Shape

- A** Specify Top Type and Finish
For Laminate Top: Manufacturer, Laminate Name, Laminate Code
For Veneer Top: Wood Stain
- B** Specify Edge Type, (for hardwood: Style), and Finish
PVC Flat/2mm Bio/2mm PVC Woodgrain/Self Edge/Hardwood
- C** Specify Base Style and Finish

Optional: Power and Data Modules, Custom Solutions

| Top Size and Shape | Top Type and Finish | Edge Type and Finish | Base Style and Finish |
|--------------------|---------------------------------|--|-----------------------|
| 18 x 18, Square | Laminate, Arborite, Brown Sugar | Hardwood, HF, Custom Brown Sugar Stain | MIDWAY, Silver |



EDGE PROFILES

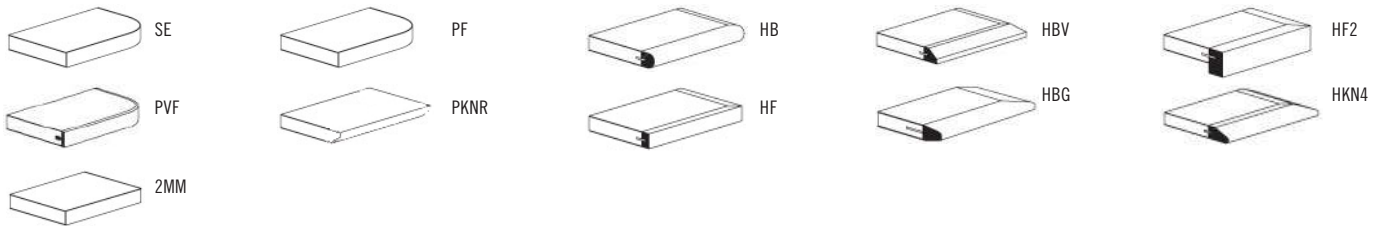



MIDWAY & COMPANION TABLES

OCCASIONAL AND LOUNGE



| MODEL | BASES | | TOP SPECIFICATIONS | | | | | | OPTIONS | LBS |
|------------------|-----------|------|--------------------|--|------------|----------------|------------------------|-------------|---------|-----|
| | Code | Qty. | For Laminate Top | | | For Veneer Top | | | | |
| | | | SE PVF 2MM | HF HB PKNR ¹ PF ¹ | HBV HBG | HF2 HKN4 | HF HB HBV HBG | HF2 HKN4 | | |
| <i>Round</i> | | | | | | | | | | |
| 24D | MIDWAY | 1 | 651 | 1011 | 1048 | 1157 | 1216 | 1328 | | 27 |
| | COMPANION | 1 | 795 | 1155 | 1192 | 1301 | 1360 | 1472 | | 27 |
| 30D | MIDWAY | 1 | 755 | 1110 | 1157 | 1375 | 1320 | 1484 | | 37 |
| | COMPANION | 1 | 899 | 1254 | 1301 | 1519 | 1464 | 1628 | | 37 |
| 36D | MIDWAY | 1 | 854 | 1367 | 1458 | 1636 | 1690 | 1919 | | 48 |
| | COMPANION | 1 | 998 | 1511 | 1602 | 1780 | 1834 | 2063 | | 48 |
| <i>Square</i> | | | | | | | | | | |
| 18 x 18SQ | MIDWAY | 1 | 671 | 877 | 914 | 982 | 1032 | 1199 | | 20 |
| | COMPANION | 1 | 815 | 1021 | 1058 | 1126 | 1176 | 1343 | | 20 |
| 24 x 24SQ | MIDWAY | 1 | 682 | 877 | 914 | 982 | 1032 | 1199 | | 27 |
| | COMPANION | 1 | 826 | 1021 | 1058 | 1126 | 1176 | 1343 | | 27 |
| 30 x 30SQ | MIDWAY | 1 | 789 | 931 | 982 | 1162 | 1096 | 1328 | | 37 |
| | COMPANION | 1 | 933 | 1075 | 1126 | 1306 | 1240 | 1472 | | 37 |
| 36 x 36SQ | MIDWAY | 1 | 872 | 1095 | 1157 | 1367 | 1375 | 1575 | | 48 |
| | COMPANION | 1 | 1016 | 1239 | 1301 | 1511 | 1519 | 1719 | | 48 |
| <i>Rectangle</i> | | | | | | | | | | |
| 24 x 48RE | MIDWAY | 1 | 843 | 1058 | 1114 | 1215 | 1276 | 1457 | | 44 |
| | COMPANION | 1 | 987 | 1202 | 1258 | 1359 | 1420 | 1601 | | 44 |

¹ Exposed Baltic Birch plywood edge (PKNR, PF) can only be specified on square or rectangle tops up to 47-1/2" x 95-1/2". Clear finish only.



STANDARD FEATURES

- Select from 15 standard laminates or choose any standard Wilsonart, Nevamar, Formica, Arborite and Pionite matte finish laminates at no upcharge. For other laminate please contact the factory for pricing.
- 9 standard veneer and hardwood edge stains. Stain-to-match available at no upcharge.
- Bases available in any Spectone color.
- Standard table height 18".
- All bases are standard with floor leveling glides.

OPTIONS

- Custom heights available.
- For applicable Power & Data modules, please see Table Accessories Price List.

HOW TO ORDER

1. Select Model
2. Select Base
3. Select Edge Style
4. Select Top Finish
5. Select Edge Finish
6. Select Base Finish

Example: 24D - MIDWAY - PVF
 MODEL | BASE | EDGE

POST LEGS TABLES



PRODUCT CODE

2430 RE P LO

Top Size

Width x Length

Top Shape

- D : Round
- SQ : Square
- RE : Rectangle
- RT : Racetrack
- B : Bullet
- H : Halfmoon
- TP : Trapezoid

Series

Post

Base

- PL : Post Legs/29" High
- PLO : Oval Post Legs/29" High
- PL18 : Post Leg/18" High
- PL018 : Oval Post Legs/18" High



OPTIONS

CASTERS



FOLDING



FINISHES

LAMINATE



Select from 15 standard laminates or choose any standard Wilsonart, Nevamar, Formica, Arborite and Pionite matte finish laminates at no upcharge

VENEER

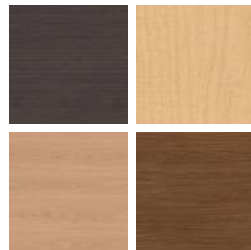

Select from one of our 9 standard wood stains or stain-to-match at no upcharge

BASE



Select from one of our 76 standard Spectone colors

EDGE



See Spectone Card or specfurniture.com/materials/finishes for a complete list of finish options and colors.



POST LEGS TABLES

HOW TO ORDER

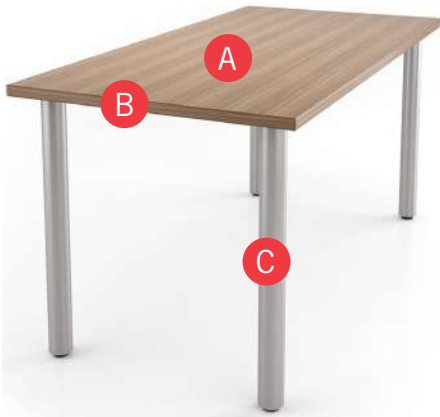

Specify Top Size (Width x Length) and Shape

- A** Specify Top Type and Finish
For Laminate Top: Manufacturer, Laminate Name, Laminate Code
For Veneer Top: Wood Stain
- B** Specify Edge Type, (for hardwood: Style), and Finish
PVC/2mm/Self Edge/Exposed Baltic Birch Plywood/Hardwood
- C** Specify Base Style and Finish

Optional: Fold, Hard Casters, Soft Casters, Grommets, Seam Connectors, Power and Data Modules, Custom Solutions

Restrictions may apply. See price list tables below for more information.

| Top Size and Shape | Top Type and Finish | Edge Type and Finish | Base Style and Finish |
|--------------------|---------------------------------|--|-----------------------|
| 24 x 48, Rectangle | Laminate, Arborite, Brown Sugar | Hardwood, HF, Custom Brown Sugar Stain | PL, Silver |



EDGE PROFILES

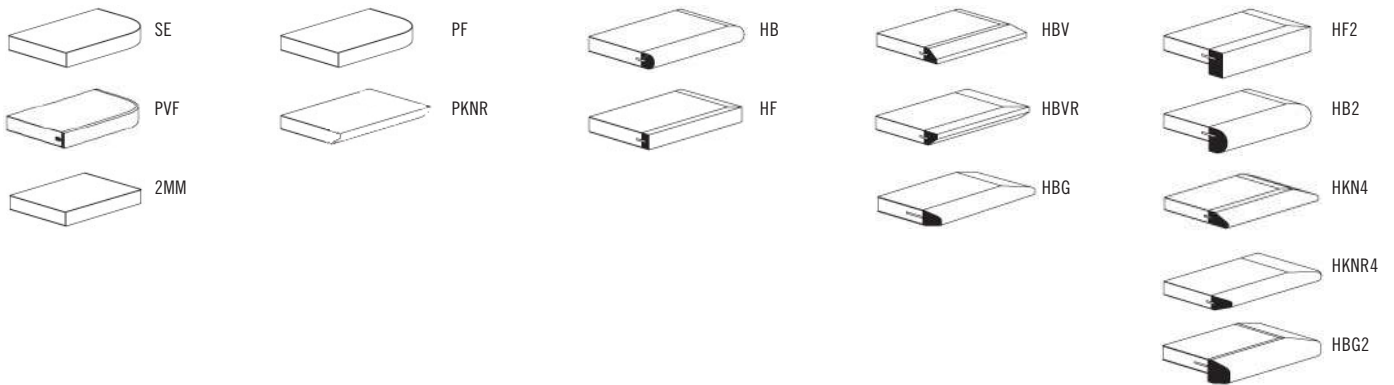



POST LEGS TABLES

OCCASIONAL AND LOUNGE



| MODEL | BASES | | TOP SPECIFICATIONS | | | | | | OPTIONS | LBS |
|---------------|-------|------|--------------------|--|--------------------|-------------------------------------|--------------------------------|-------------------------------------|---------|-----|
| | Code | Qty. | For Laminate Top | | | For Veneer Top | | | | |
| | | | SE PVF 2MM | HF HB PKNR ¹ PF ¹ | HBV HBVR HBG | HF2 HB2 HKN4 HKNR4 HBG2 | HF HB HBV HBVR HBG | HF2 HB2 HKN4 HKNR4 HBG2 | | |
| <i>Round</i> | | | | | | | | | | |
| 24D | PL18 | 4 | 651 | 1011 | 1048 | 1157 | 1216 | 1328 | | 37 |
| | PL018 | 4 | 691 | 1051 | 1088 | 1197 | 1256 | 1368 | | 37 |
| 30D | PL18 | 4 | 755 | 1110 | 1157 | 1375 | 1320 | 1484 | | 47 |
| | PL018 | 4 | 795 | 1150 | 1197 | 1415 | 1360 | 1524 | | 47 |
| 36D | PL18 | 4 | 854 | 1367 | 1458 | 1636 | 1690 | 1919 | | 58 |
| | PL018 | 4 | 894 | 1407 | 1498 | 1676 | 1730 | 1959 | | 58 |
| 42D | PL18 | 4 | 1139 | 1715 | 1839 | 2104 | 2130 | 2443 | | 76 |
| | PL018 | 4 | 1179 | 1755 | 1879 | 2144 | 2170 | 2483 | | 76 |
| <i>Square</i> | | | | | | | | | | |
| 18 x 18SQ | PL18 | 4 | 671 | 877 | 914 | 982 | 1032 | 1199 | | 34 |
| | PL018 | 4 | 711 | 917 | 954 | 1022 | 1072 | 1239 | | 34 |
| 24 x 24SQ | PL18 | 4 | 682 | 877 | 914 | 982 | 1032 | 1199 | | 41 |
| | PL018 | 4 | 722 | 917 | 954 | 1022 | 1072 | 1239 | | 41 |
| 30 x 30SQ | PL18 | 4 | 789 | 931 | 982 | 1162 | 1096 | 1328 | | 51 |
| | PL018 | 4 | 829 | 971 | 1022 | 1202 | 1136 | 1368 | | 51 |
| 36 x 36SQ | PL18 | 4 | 872 | 1095 | 1157 | 1367 | 1375 | 1575 | | 62 |
| | PL018 | 4 | 912 | 1135 | 1197 | 1407 | 1415 | 1615 | | 62 |

¹ Exposed Baltic Birch plywood edge (PKNR, PF) can only be specified on square tops up to 47-1/2" x 95-1/2". Clear finish only.



24D-PL18



24D-PL018



24SQ-PL18



24SQ-PL018

STANDARD FEATURES

- Select from 15 standard laminates or choose any standard Wilsonart, Nevamar, Formica, Arborite and Pionite matte finish laminates at no upcharge. For other laminate please contact the factory for pricing.
- 9 standard veneer and hardwood edge stains. Stain-to-match available at no upcharge.
- Bases available in any Spectone color.
- Standard table height 18".
- All bases are standard with floor leveling glides.
- PL is constructed from 2.5" dia round steel tube, PLO is constructed from 3.5" x 2.5" OD oval steel tube.

OPTIONS

- Custom heights available.
- For applicable Power & Data modules, please see Table Accessories Price List.

HOW TO ORDER

1. Select Model
2. Select Base
3. Select Edge Style
4. Select Top Finish
5. Select Edge Finish
6. Select Base Finish

Example: 24D - PL18 - PVF
 MODEL | BASE | EDGE



POST LEGS TABLES OCCASIONAL AND LOUNGE



| MODEL | BASES | | TOP SPECIFICATIONS | | | | | | OPTIONS | LBS |
|------------------|-------------|-------------|--------------------|-------------------------|------|-------|-----------------------|-------|---------|-----|
| | <i>Code</i> | <i>Qty.</i> | | <i>For Laminate Top</i> | | | <i>For Veneer Top</i> | | | |
| | | | SE | HF | HBV | HF2 | HF | HF2 | | |
| | | | PVF | HB | HBVR | HB2 | HB | HB2 | | |
| | | | 2MM | PKNR ¹ | HVG | HKN4 | HBV | HKN4 | | |
| | | | | PF ¹ | | HKNR4 | HBVR | HKNR4 | | |
| | | | | | | HVG2 | HVG | HVG2 | | |
| <i>Rectangle</i> | | | | | | | | | | |
| 24 x 36RE | PL18 | 4 | 778 | 910 | 959 | 1027 | 1080 | 1211 | | 50 |
| | PL018 | 4 | 818 | 950 | 999 | 1067 | 1120 | 1251 | | 50 |
| 24 x 42RE | PL18 | 4 | 843 | 1058 | 1114 | 1215 | 1276 | 1457 | | 58 |
| | PL018 | 4 | 883 | 1098 | 1154 | 1255 | 1316 | 1497 | | 58 |
| 24 x 48RE | PL18 | 4 | 843 | 1058 | 1114 | 1215 | 1276 | 1457 | | 58 |
| | PL018 | 4 | 883 | 1098 | 1154 | 1255 | 1316 | 1497 | | 58 |
| 30 x 36RE | PL18 | 4 | 872 | 1027 | 1081 | 1170 | 1232 | 1390 | | 56 |
| | PL018 | 4 | 912 | 1067 | 1121 | 1210 | 1272 | 1430 | | 56 |
| 30 x 42RE | PL18 | 4 | 894 | 1188 | 1255 | 1371 | 1457 | 1677 | | 66 |
| | PL018 | 4 | 934 | 1228 | 1295 | 1411 | 1497 | 1717 | | 66 |
| 30 x 48RE | PL18 | 4 | 894 | 1188 | 1255 | 1371 | 1457 | 1677 | | 66 |
| | PL018 | 4 | 934 | 1228 | 1295 | 1411 | 1497 | 1717 | | 66 |



¹ Exposed Baltic Birch plywood edge (PKNR, PF) can only be specified on tops up to 47-1/2" x 95-1/2". Clear finish only.



2448RE-PL18

STANDARD FEATURES

- Select from 15 standard laminates or choose any standard Wilsonart, Nevamar, Formica, Arborite and Pionite matte finish laminates at no upcharge. For other laminate please contact the factory for pricing.
- 9 standard veneer and hardwood edge stains. Stain-to-match available at no upcharge.
- Bases available in any Spectone color.
- Standard table height 18".
- All bases are standard with floor leveling glides.
- PL is constructed from 2.5" dia round steel tube, PLO is constructed from 3.5" x 2.5" OD oval steel tube.

OPTIONS

- Custom heights available.
- For applicable Power & Data modules, please see Table Accessories Price List.

HOW TO ORDER

1. Select Model
2. Select Base
3. Select Edge Style
4. Select Top Finish
5. Select Edge Finish
6. Select Base Finish

Example: 2448RE - PL18 - PVF





BACK TO CONTENTS

POST LEGS TABLES GENERAL PURPOSE



| MODEL | BASES | | TOP SPECIFICATIONS | | | | | | OPTIONS | | | LBS |
|--------------|-------|------|--------------------|----------|------------|-------------------------------------|--------------------------------|-------------------------------------|-----------|---------|-----------|-----------|
| | Code | Qty. | For Laminate Top | | | For Veneer Top | | | FOLD (FL) | CASTERS | | |
| | | | SE PVF 2MM | HF HB | HBV HBG | HF2 HB2 HKN4 HKNR4 HBG2 | HF HB HBV HBVR HBG | HF2 HB2 HKN4 HKNR4 HBG2 | | | HARD (HC) | SOFT (SC) |
| <i>Round</i> | | | | | | | | | | | | |
| 24D | PL | 4 | 651 | 1011 | 1048 | 1157 | 1216 | 1328 | | 96 | 204 | 41 |
| | PLO | 4 | 691 | 1051 | 1088 | 1197 | 1256 | 1368 | | 96 | 204 | 37 |
| 30D | PL | 4 | 755 | 1110 | 1157 | 1375 | 1320 | 1484 | | 96 | 204 | 51 |
| | PLO | 4 | 795 | 1150 | 1197 | 1415 | 1360 | 1524 | | 96 | 204 | 47 |
| 36D | PL | 4 | 854 | 1367 | 1458 | 1636 | 1690 | 1919 | | 96 | 204 | 62 |
| | PLO | 4 | 894 | 1407 | 1498 | 1676 | 1730 | 1959 | | 96 | 204 | 58 |
| 42D | PL | 4 | 1139 | 1715 | 1839 | 2104 | 2130 | 2443 | | 96 | 204 | 76 |
| | PLO | 4 | 1179 | 1755 | 1879 | 2144 | 2170 | 2483 | | 96 | 204 | 72 |
| 48D | PL | 4 | 1162 | 1935 | 2070 | 2202 | 2676 | 3078 | | 96 | 204 | 92 |
| | PLO | 4 | 1202 | 1975 | 2110 | 2242 | 2716 | 3118 | | 96 | 204 | 88 |
| 54D | PL | 4 | 1452 | 2592 | 2802 | 3002 | 3238 | 3754 | 597 | 96 | 204 | 110 |
| | PLO | 4 | 1492 | 2632 | 2842 | 3042 | 3278 | 3794 | | 96 | 204 | 106 |
| 60D | PL | 4 | 1500 | 2794 | 3018 | 3187 | 3873 | 4514 | 597 | 96 | 204 | 129 |
| | PLO | 4 | 1540 | 2834 | 3058 | 3227 | 3913 | 4554 | | 96 | 204 | 125 |

*Folding tables available with PVC Flat (PVF) edge only.



2448RE-PL



2448RE-PLO

STANDARD FEATURES

- Select from 15 standard laminates or choose any standard Wilsonart, Nevamar, Formica, Arborite and Pionite matte finish laminates at no upcharge. For other laminate please contact the factory for pricing.
- 9 standard veneer and hardwood edge stains. Stain-to-match available at no upcharge.
- Bases available in any Spectone color.
- Standard table height 29".
- All bases are standard with floor leveling glides.
- PL is constructed from 2.5" dia round steel tube, PLO is constructed from 3.5" x 2.5" OD oval steel tube.

OPTIONS

- Custom heights available.
- For applicable Power & Data modules, please see Table Accessories Price List.

HOW TO ORDER

1. Select Model
2. Select Base
3. Select Edge Style
4. Select Options
5. Select Top Finish
6. Select Edge Finish
7. Select Base Finish

Example: 24D - PL - PVF -





BACK TO CONTENTS

POST LEGS TABLES

GENERAL PURPOSE

| MODEL | BASES | | TOP SPECIFICATIONS | | | | | | OPTIONS | | | LBS |
|---------------|-------|------|--------------------|--|--------------------|-------------------------------------|--------------------------------|-------------------------------------|-----------|-----------------------------|-----|-----|
| | Code | Qty. | For Laminate Top | | | For Veneer Top | | | FOLD (FL) | CASTERS HARD (HC) SOFT (SC) | | |
| | | | SE PVF 2MM | HF HB PKNR ¹ PF ¹ | HBV HBVR HBG | HF2 HB2 HKN4 HKNR4 HBG2 | HF HB HBV HBVR HBG | HF2 HB2 HKN4 HKNR4 HBG2 | | | | |
| <i>Square</i> | | | | | | | | | | | | |
| 24 x 24SQ | PL | 4 | 682 | 877 | 914 | 982 | 1032 | 1199 | | 96 | 204 | 41 |
| | PLO | 4 | 722 | 917 | 954 | 1022 | 1072 | 1239 | | 96 | 204 | 37 |
| 30 x 30SQ | PL | 4 | 789 | 931 | 982 | 1162 | 1096 | 1328 | | 96 | 204 | 51 |
| | PLO | 4 | 829 | 971 | 1022 | 1202 | 1136 | 1368 | | 96 | 204 | 47 |
| 36 x 36SQ | PL | 4 | 872 | 1095 | 1157 | 1367 | 1375 | 1575 | | 96 | 204 | 58 |
| | PLO | 4 | 912 | 1135 | 1197 | 1407 | 1415 | 1615 | | 96 | 204 | 58 |
| 42 x 42SQ | PL | 4 | 1153 | 1476 | 1575 | 1675 | 1744 | 2017 | 597 | 96 | 204 | 76 |
| | PLO | 4 | 1193 | 1516 | 1615 | 1715 | 1784 | 2057 | | 96 | 204 | 72 |
| 48 x 48SQ | PL | 4 | 1307 | 1590 | 1695 | 1742 | 2120 | 2473 | 597 | 96 | 204 | 92 |
| | PLO | 4 | 1347 | 1630 | 1735 | 1782 | 2160 | 2513 | | 96 | 204 | 88 |
| 54 x 54SQ | PL | 5 | 1573 | 2197 | 2361 | 2551 | 2655 | 3112 | 745 | 96 | 204 | 116 |
| | PLO | 5 | 1623 | 2247 | 2411 | 2601 | 2705 | 3162 | | 96 | 204 | 111 |
| 60 x 60SQ | PL | 5 | 1603 | 2303 | 2478 | 2669 | 3134 | 3687 | 745 | 96 | 204 | 135 |
| | PLO | 5 | 1653 | 2353 | 2528 | 2719 | 3184 | 3737 | | 96 | 204 | 130 |



*Folding tables available with PVC Flat (PVF) edge only.

¹ Exposed Baltic Birch plywood edge (PKNR, PF) can only be specified on tops up to 47-1/2" x 95-1/2". Clear finish only.



2448RE-PL



2448RE-PLO

STANDARD FEATURES

- Select from 15 standard laminates or choose any standard Wilsonart, Nevamar, Formica, Arborite and Pionite matte finish laminates at no upcharge. For other laminate please contact the factory for pricing.
- 9 standard veneer and hardwood edge stains. Stain-to-match available at no upcharge.
- Bases available in any Spectone color.
- Standard table height 29".
- All bases are standard with floor leveling glides.
- PL is constructed from 2.5" dia round steel tube, PLO is constructed from 3.5" x 2.5" OD oval steel tube.

OPTIONS

- Custom heights available.
- For applicable Power & Data modules, please see Table Accessories Price List.

HOW TO ORDER

1. Select Model
2. Select Base
3. Select Edge Style
4. Select Options
5. Select Top Finish
6. Select Edge Finish
7. Select Base Finish

Example: 2424SQ - PL - PVF -





POST LEGS TABLES

GENERAL PURPOSE

| MODEL | BASES | | TOP SPECIFICATIONS | | | | | | OPTIONS | | | LBS |
|------------------|-------|------|--------------------|--|--------------------|-------------------------------------|--------------------------------|-------------------------------------|-----------|---------|-----------|-----------|
| | Code | Qty. | For Laminate Top | | | For Veneer Top | | | FOLD (FL) | CASTERS | | |
| | | | SE PVF 2MM | HF HB PKNR ¹ PF ¹ | HBV HBVR HBG | HF2 HB2 HKN4 HKNR4 HBG2 | HF HB HBV HBVR HBG | HF2 HB2 HKN4 HKNR4 HBG2 | | | HARD (HC) | SOFT (SC) |
| <i>Rectangle</i> | | | | | | | | | | | | |
| 24 x 30RE | PL | 4 | 778 | 910 | 959 | 1027 | 1080 | 1211 | | 96 | 204 | 50 |
| | PLO | 4 | 818 | 950 | 999 | 1067 | 1120 | 1251 | | 96 | 204 | 46 |
| 24 x 36RE | PL | 4 | 778 | 910 | 959 | 1027 | 1080 | 1211 | | 96 | 204 | 50 |
| | PLO | 4 | 818 | 950 | 999 | 1067 | 1120 | 1251 | | 96 | 204 | 46 |
| 24 x 42RE | PL | 4 | 843 | 1058 | 1114 | 1215 | 1276 | 1457 | | 96 | 204 | 58 |
| | PLO | 4 | 883 | 1098 | 1154 | 1255 | 1316 | 1497 | | 96 | 204 | 54 |
| 24 x 48RE | PL | 4 | 843 | 1058 | 1114 | 1215 | 1276 | 1457 | | 96 | 204 | 58 |
| | PLO | 4 | 883 | 1098 | 1154 | 1255 | 1316 | 1497 | | 96 | 204 | 54 |
| 24 x 54RE | PL | 4 | 904 | 1217 | 1287 | 1403 | 1490 | 1712 | | 96 | 204 | 66 |
| | PLO | 4 | 944 | 1257 | 1327 | 1443 | 1530 | 1752 | | 96 | 204 | 62 |
| 24 x 60RE | PL | 4 | 904 | 1217 | 1287 | 1403 | 1490 | 1712 | 597 | 96 | 204 | 66 |
| | PLO | 4 | 944 | 1257 | 1327 | 1443 | 1530 | 1752 | | 96 | 204 | 62 |
| 24 x 66RE | PL | 4 | 1052 | 1429 | 1515 | 1657 | 1748 | 2020 | 597 | 96 | 204 | 81 |
| | PLO | 4 | 1092 | 1469 | 1555 | 1697 | 1788 | 2060 | | 96 | 204 | 76 |
| 24 x 72RE | PL | 5 | 1170 | 1547 | 1633 | 1775 | 1866 | 2138 | 745 | 116 | 254 | 81 |
| | PLO | 5 | 1220 | 1597 | 1683 | 1825 | 1916 | 2188 | | 116 | 254 | 76 |

*Folding tables available with PVC Flat (PVF) edge only.

¹ Exposed Baltic Birch plywood edge (PKNR, PF) can only be specified on tops up to 47-1/2" x 95-1/2". Clear finish only.



2448RE-PL



2448RE-PLO

STANDARD FEATURES

- Select from 15 standard laminates or choose any standard Wilsonart, Nevamar, Formica, Arborite and Pionite matte finish laminates at no upcharge. For other laminate please contact the factory for pricing.
- 9 standard veneer and hardwood edge stains. Stain-to-match available at no upcharge.
- Bases available in any Spectone color.
- Standard table height 29".
- All bases are standard with floor leveling glides.
- PL is constructed from 2.5" dia round steel tube, PLO is constructed from 3.5" x 2.5" OD oval steel tube.

OPTIONS

- Custom heights available.
- For applicable Power & Data modules, please see Table Accessories Price List.

HOW TO ORDER

1. Select Model
2. Select Base
3. Select Edge Style
4. Select Options
5. Select Top Finish
6. Select Edge Finish
7. Select Base Finish

Example: 2430RE - PL - PVF -





POST LEGS TABLES

GENERAL PURPOSE

| MODEL | BASES | | TOP SPECIFICATIONS | | | | | | OPTIONS | | | LBS |
|------------------|-------|------|--------------------|--|--------------------|-------------------------------------|--------------------------------|-------------------------------------|-----------|---------|-----------|-----------|
| | Code | Qty. | For Laminate Top | | | For Veneer Top | | | FOLD (FL) | CASTERS | | |
| | | | SE PVF 2MM | HF HB PKNR ¹ PF ¹ | HBV HBVR HBG | HF2 HB2 HKN4 HKNR4 HBG2 | HF HB HBV HBVR HBG | HF2 HB2 HKN4 HKNR4 HBG2 | | | HARD (HC) | SOFT (SC) |
| <i>Rectangle</i> | | | | | | | | | | | | |
| 30 x 36RE | PL | 4 | 872 | 1027 | 1081 | 1170 | 1232 | 1390 | | 96 | 204 | 56 |
| | PLO | 4 | 912 | 1067 | 1121 | 1210 | 1272 | 1430 | | 96 | 204 | 52 |
| 30 x 42RE | PL | 4 | 894 | 1188 | 1255 | 1371 | 1457 | 1677 | | 96 | 204 | 66 |
| | PLO | 4 | 934 | 1228 | 1295 | 1411 | 1497 | 1717 | | 96 | 204 | 62 |
| 30 x 48RE | PL | 4 | 894 | 1188 | 1255 | 1371 | 1457 | 1677 | | 96 | 204 | 66 |
| | PLO | 4 | 934 | 1228 | 1295 | 1411 | 1497 | 1717 | | 96 | 204 | 62 |
| 30 x 54RE | PL | 4 | 955 | 1355 | 1442 | 1608 | 1706 | 1982 | | 96 | 204 | 77 |
| | PLO | 4 | 995 | 1395 | 1482 | 1648 | 1746 | 2022 | | 96 | 204 | 73 |
| 30 x 60RE | PL | 4 | 955 | 1355 | 1442 | 1608 | 1706 | 1982 | 597 | 96 | 204 | 77 |
| | PLO | 4 | 995 | 1395 | 1482 | 1648 | 1746 | 2022 | | 96 | 204 | 73 |
| 30 x 66RE | PL | 4 | 1131 | 1456 | 1562 | 1729 | 1825 | 2130 | 597 | 96 | 204 | 93 |
| | PLO | 4 | 1171 | 1496 | 1602 | 1769 | 1865 | 2170 | | 96 | 204 | 88 |
| 30 x 72RE | PL | 5 | 1307 | 1730 | 1837 | 2053 | 2166 | 2502 | 745 | 116 | 254 | 93 |
| | PLO | 5 | 1357 | 1780 | 1887 | 2103 | 2216 | 2552 | | 116 | 254 | 88 |
| 30 x 78RE | PL | 5 | 1535 | 1910 | 2037 | 2288 | 2420 | 2806 | 745 | 116 | 254 | 104 |
| | PLO | 5 | 1585 | 1960 | 2087 | 2338 | 2470 | 2856 | | 116 | 254 | 99 |
| 30 x 84RE | PL | 5 | 1535 | 1910 | 2037 | 2288 | 2420 | 2806 | 745 | 116 | 254 | 104 |
| | PLO | 5 | 1585 | 1960 | 2087 | 2338 | 2470 | 2856 | | 116 | 254 | 99 |
| 30 x 90RE | PL | 5 | 1557 | 2135 | 2288 | 2520 | 2676 | 3116 | 745 | 116 | 254 | 114 |
| | PLO | 5 | 1607 | 2185 | 2338 | 2570 | 2726 | 3166 | | 116 | 254 | 109 |
| 30 x 96RE | PL | 6 | 1675 | 2253 | 2406 | 2638 | 2794 | 3234 | | 141 | 304 | 114 |
| | PLO | 6 | 1735 | 2313 | 2466 | 2698 | 2854 | 3294 | | 141 | 304 | 109 |

*Folding tables available with PVC Flat (PVF) edge only.

¹ Exposed Baltic Birch plywood edge (PKNR, PF) can only be specified on tops up to 47-1/2" x 95-1/2". Clear finish only.



2448RE-PL
STANDARD FEATURES

- Select from 15 standard laminates or choose any standard Wilsonart, Nevamar, Formica, Arborite and Pionite matte finish laminates at no upcharge. For other laminate please contact the factory for pricing.
- 9 standard veneer and hardwood edge stains. Stain-to-match available at no upcharge.
- Bases available in any Spectone color.
- Standard table height 29".
- All bases are standard with floor leveling glides.
- PL is constructed from 2.5" dia round steel tube, PLO is constructed from 3.5" x 2.5" OD oval steel tube.



2448RE-PLO

OPTIONS

- Custom heights available.
- For applicable Power & Data modules, please see Table Accessories Price List.

HOW TO ORDER

1. Select Model
2. Select Base
3. Select Edge Style
4. Select Options
5. Select Top Finish
6. Select Edge Finish
7. Select Base Finish

Example: 3036RE - PL - PVF -





BACK TO CONTENTS

POST LEGS TABLES

GENERAL PURPOSE

| MODEL | BASES | | TOP SPECIFICATIONS | | | | | | OPTIONS | | | LBS |
|------------------|-------|------|--------------------|--|--------------------|-------------------------------------|--------------------------------|-------------------------------------|-----------|-------------------|-----------|-----|
| | Code | Qty. | For Laminate Top | | | For Veneer Top | | | FOLD (FL) | CASTERS HARD (HC) | SOFT (SC) | |
| | | | SE PVF 2MM | HF HB PKNR ¹ PF ¹ | HBV HBVR HBG | HF2 HB2 HKN4 HKNR4 HBG2 | HF HB HBV HBVR HBG | HF2 HB2 HKN4 HKNR4 HBG2 | | | | |
| <i>Rectangle</i> | | | | | | | | | | | | |
| 36 x 42RE | PL | 4 | 996 | 1217 | 1301 | 1416 | 1506 | 1737 | | 96 | 204 | 75 |
| | PLO | 4 | 1036 | 1257 | 1341 | 1456 | 1546 | 1777 | | 96 | 204 | 71 |
| 36 x 48RE | PL | 4 | 1021 | 1333 | 1424 | 1562 | 1653 | 1924 | | 96 | 204 | 75 |
| | PLO | 4 | 1061 | 1373 | 1464 | 1602 | 1693 | 1964 | | 96 | 204 | 71 |
| 36 x 60RE | PL | 4 | 1120 | 1554 | 1664 | 1840 | 1951 | 2289 | 597 | 96 | 204 | 87 |
| | PLO | 4 | 1160 | 1594 | 1704 | 1880 | 1991 | 2329 | | 96 | 204 | 83 |
| 36 x 66RE | PL | 4 | 1210 | 1660 | 1787 | 1980 | 2102 | 2473 | 597 | 96 | 204 | 106 |
| | PLO | 4 | 1250 | 1700 | 1827 | 2020 | 2142 | 2513 | | 96 | 204 | 101 |
| 36 x 72RE | PL | 5 | 1367 | 1837 | 1958 | 2237 | 2373 | 2774 | 745 | 116 | 254 | 106 |
| | PLO | 5 | 1417 | 1887 | 2008 | 2287 | 2423 | 2824 | | 116 | 254 | 101 |
| 36 x 78RE | PL | 5 | 1708 | 2211 | 2369 | 2612 | 2770 | 3243 | 745 | 116 | 254 | 119 |
| | PLO | 5 | 1758 | 2261 | 2419 | 2662 | 2820 | 3293 | | 116 | 254 | 114 |
| 36 x 84RE | PL | 5 | 1708 | 2211 | 2369 | 2612 | 2770 | 3243 | 745 | 116 | 254 | 119 |
| | PLO | 5 | 1758 | 2261 | 2419 | 2662 | 2820 | 3293 | | 116 | 254 | 114 |
| 36 x 90RE | PL | 6 | 1833 | 2550 | 2730 | 3013 | 3195 | 3719 | | 141 | 304 | 137 |
| | PLO | 6 | 1893 | 2610 | 2790 | 3073 | 3255 | 3779 | | 141 | 304 | 131 |
| 36 x 96RE | PL | 6 | 1833 | 2550 | 2730 | 3013 | 3195 | 3719 | | 141 | 304 | 137 |
| | PLO | 6 | 1893 | 2610 | 2790 | 3073 | 3255 | 3779 | | 141 | 304 | 131 |

*Folding tables available with PVC Flat (PVF) edge only.

¹ Exposed Baltic Birch plywood edge (PKNR, PF) can only be specified on tops up to 47-1/2" x 95-1/2". Clear finish only.



2448RE-PL



2448RE-PLO

STANDARD FEATURES

- Select from 15 standard laminates or choose any standard Wilsonart, Nevamar, Formica, Arborite and Pionite matte finish laminates at no upcharge. For other laminate please contact the factory for pricing.
- 9 standard veneer and hardwood edge stains. Stain-to-match available at no upcharge.
- Bases available in any Spectone color.
- Standard table height 29".
- All bases are standard with floor leveling glides.
- PL is constructed from 2.5" dia round steel tube, PLO is constructed from 3.5" x 2.5" OD oval steel tube.

OPTIONS

- Custom heights available.
- For applicable Power & Data modules, please see Table Accessories Price List.

HOW TO ORDER

1. Select Model
2. Select Base
3. Select Edge Style
4. Select Options
5. Select Top Finish
6. Select Edge Finish
7. Select Base Finish

Example: 3642RE - PL - PVF -





POST LEGS TABLES

GENERAL PURPOSE



| MODEL | BASES | | TOP SPECIFICATIONS | | | | | | OPTIONS | | LBS |
|------------------|-------|------|--------------------|--|--------------------|-------------------------------------|--------------------------------|-------------------------------------|--------------------------------|-----|-----|
| | Code | Qty. | For Laminate Top | | | For Veneer Top | | | CASTERS HARD (HC) SOFT (SC) | | |
| | | | SE PVF 2MM | HF HB PKNR ¹ PF ¹ | HBV HBVR HBG | HF2 HB2 HKN4 HKNR4 HBG2 | HF HB HBV HBVR HBG | HF2 HB2 HKN4 HKNR4 HBG2 | | | |
| <i>Rectangle</i> | | | | | | | | | | | |
| 42 x 78RE | PL | 5 | 1956 | 2388 | 2561 | 2979 | 3116 | 3664 | 116 | 254 | 133 |
| | PLO | 5 | 2006 | 2438 | 2611 | 3029 | 3166 | 3714 | 116 | 254 | 128 |
| 42 x 84RE | PL | 5 | 1956 | 2388 | 2561 | 2979 | 3116 | 3664 | 116 | 254 | 133 |
| | PLO | 5 | 2006 | 2438 | 2611 | 3029 | 3166 | 3714 | 116 | 254 | 128 |

¹ Exposed Baltic Birch plywood edge (PKNR, PF) can only be specified on tops up to 47-1/2" x 95-1/2". Clear finish only.



2448RE-PL



2448RE-PLO

STANDARD FEATURES

- Select from 15 standard laminates or choose any standard Wilsonart, Nevamar, Formica, Arborite and Pionite matte finish laminates at no upcharge. For other laminate please contact the factory for pricing.
- 9 standard veneer and hardwood edge stains. Stain-to-match available at no upcharge.
- Bases available in any Spectone color.
- Standard table height 29".
- All bases are standard with floor leveling glides.
- PL is constructed from 2.5" dia round steel tube, PLO is constructed from 3.5" x 2.5" OD oval steel tube.

OPTIONS

- Custom heights available.
- For applicable Power & Data modules, please see Table Accessories Price List.

HOW TO ORDER

1. Select Model
2. Select Base
3. Select Edge Style
4. Select Options
5. Select Top Finish
6. Select Edge Finish
7. Select Base Finish

Example: 3696RE - PL - PVF -





BACK TO CONTENTS

POST LEGS TABLES

GENERAL PURPOSE

| MODEL | BASES | | TOP SPECIFICATIONS | | | | | | OPTIONS | | LBS |
|------------------|-------|------|--------------------|----------|--------------------|-------------------------------------|--------------------------------|-------------------------------------|--------------------------------|-----|-----|
| | Code | Qty. | For Laminate Top | | | For Veneer Top | | | CASTERS HARD (HC) SOFT (SC) | | |
| | | | SE PVF 2MM | HF HB | HBV HBVR HBG | HF2 HB2 HKN4 HKNR4 HBG2 | HF HB HBV HBVR HBG | HF2 HB2 HKN4 HKNR4 HBG2 | | | |
| <i>Racetrack</i> | | | | | | | | | | | |
| 36 x 54RT | PL | 4 | 1177 | 1748 | 1881 | 2119 | 2217 | 2566 | 96 | 204 | 87 |
| | PLO | 4 | 1217 | 1788 | 1921 | 2159 | 2257 | 2606 | 96 | 204 | 83 |
| 36 x 60RT | PL | 4 | 1177 | 1748 | 1881 | 2119 | 2217 | 2566 | 96 | 204 | 87 |
| | PLO | 4 | 1217 | 1788 | 1921 | 2159 | 2257 | 2606 | 96 | 204 | 83 |
| 36 x 66RT | PL | 4 | 1338 | 1935 | 2079 | 2334 | 2558 | 2994 | 96 | 204 | 100 |
| | PLO | 4 | 1378 | 1975 | 2119 | 2374 | 2598 | 3034 | 96 | 204 | 96 |
| 36 x 72RT | PL | 4 | 1338 | 1935 | 2079 | 2334 | 2558 | 2994 | 96 | 204 | 100 |
| | PLO | 4 | 1378 | 1975 | 2119 | 2374 | 2598 | 3034 | 96 | 204 | 96 |
| 36 x 78RT | PL | 4 | 1608 | 2366 | 2543 | 2928 | 3009 | 3517 | 96 | 204 | 119 |
| | PLO | 4 | 1648 | 2406 | 2583 | 2968 | 3049 | 3557 | 96 | 204 | 114 |
| 36 x 84RT | PL | 5 | 1726 | 2484 | 2661 | 3046 | 3127 | 3635 | 116 | 254 | 119 |
| | PLO | 5 | 1776 | 2534 | 2711 | 3096 | 3177 | 3685 | 116 | 254 | 114 |
| 36 x 90RT | PL | 5 | 1730 | 2741 | 2952 | 3383 | 3484 | 4063 | 116 | 254 | 131 |
| | PLO | 5 | 1780 | 2791 | 3002 | 3433 | 3534 | 4113 | 116 | 254 | 126 |
| 36 x 96RT | PL | 6 | 1848 | 2859 | 3070 | 3501 | 3602 | 4181 | 141 | 304 | 131 |
| | PLO | 6 | 1908 | 2919 | 3130 | 3561 | 3662 | 4241 | 141 | 304 | 126 |



2448RE-PL



2448RE-PLO

STANDARD FEATURES

- Select from 15 standard laminates or choose any standard Wilsonart, Nevamar, Formica, Arborite and Pionite matte finish laminates at no upcharge. For other laminate please contact the factory for pricing.
- 9 standard veneer and hardwood edge stains. Stain-to-match available at no upcharge.
- Bases available in any Spectone color.
- Standard table height 29".
- All bases are standard with floor leveling glides.
- PL is constructed from 2.5" dia round steel tube, PLO is constructed from 3.5" x 2.5" OD oval steel tube.

OPTIONS

- Custom heights available.
- For applicable Power & Data modules, please see Table Accessories Price List.

HOW TO ORDER

1. Select Model
2. Select Base
3. Select Edge Style
4. Select Options
5. Select Top Finish
6. Select Edge Finish
7. Select Base Finish

Example: 3654RT - PL - PVF -





POST LEGS TABLES

GENERAL PURPOSE

| MODEL | BASES | | TOP SPECIFICATIONS | | | | | | OPTIONS | | LBS |
|------------------|-------|------|--------------------|----------|--------------------|-------------------------------------|--------------------------------|-------------------------------------|--------------------------------|-----|-----|
| | Code | Qty. | For Laminate Top | | | For Veneer Top | | | CASTERS HARD (HC) SOFT (SC) | | |
| | | | SE PVF 2MM | HF HB | HBV HBVR HBG | HF2 HB2 HKN4 HKNR4 HBG2 | HF HB HBV HBVR HBG | HF2 HB2 HKN4 HKNR4 HBG2 | | | |
| <i>Racetrack</i> | | | | | | | | | | | |
| 42 x 78RT | PL | 4 | 1853 | 2570 | 2787 | 3223 | 3328 | 3912 | 96 | 204 | 142 |
| | PLO | 4 | 1893 | 2610 | 2827 | 3263 | 3368 | 3952 | 96 | 204 | 138 |
| 42 x 84RT | PL | 4 | 1853 | 2570 | 2787 | 3223 | 3328 | 3912 | 96 | 204 | 142 |
| | PLO | 4 | 1893 | 2610 | 2827 | 3263 | 3368 | 3952 | 96 | 204 | 138 |
| 48 x 78RT | PL | 4 | 1856 | 2878 | 3124 | 3510 | 3751 | 4415 | 96 | 204 | 142 |
| | PLO | 4 | 1896 | 2918 | 3164 | 3550 | 3791 | 4455 | 96 | 204 | 138 |
| 48 x 84RT | PL | 4 | 1856 | 2878 | 3124 | 3510 | 3751 | 4415 | 96 | 204 | 142 |
| | PLO | 4 | 1896 | 2918 | 3164 | 3550 | 3791 | 4455 | 96 | 204 | 138 |



2448RE-PL



2448RE-PLO

STANDARD FEATURES

- Select from 15 standard laminates or choose any standard Wilsonart, Nevamar, Formica, Arborite and Pionite matte finish laminates at no upcharge. For other laminate please contact the factory for pricing.
- 9 standard veneer and hardwood edge stains. Stain-to-match available at no upcharge.
- Bases available in any Spectone color.
- Standard table height 29".
- All bases are standard with floor leveling glides.
- PL is constructed from 2.5" dia round steel tube, PLO is constructed from 3.5" x 2.5" OD oval steel tube.

OPTIONS

- Custom heights available.
- For applicable Power & Data modules, please see Table Accessories Price List.

HOW TO ORDER

1. Select Model
2. Select Base
3. Select Edge Style
4. Select Options
5. Select Top Finish
6. Select Edge Finish
7. Select Base Finish

Example: 4278RT - PL - PVF -





POST LEGS TABLES

GENERAL PURPOSE

| MODEL | BASES | | TOP SPECIFICATIONS | | | | | | OPTIONS | | LBS |
|---------------|-------|------|--------------------|----------|------------|-------------------------------------|--------------------------------|-------------------------------------|--------------------------------|-----|-----|
| | Code | Qty. | For Laminate Top | | | For Veneer Top | | | CASTERS HARD (HC) SOFT (SC) | | |
| | | | SE PVF 2MM | HF HB | HBV HBG | HF2 HB2 HKN4 HKNR4 HBG2 | HF HB HBV HBVR HBG | HF2 HB2 HKN4 HKNR4 HBG2 | | | |
| <i>Bullet</i> | | | | | | | | | | | |
| 30 x 54B | PL | 4 | 1076 | 1645 | 1764 | 1972 | 2034 | 2378 | 96 | 204 | 77 |
| | PLO | 4 | 1116 | 1685 | 1804 | 2012 | 2074 | 2418 | 96 | 204 | 73 |
| 30 x 60B | PL | 4 | 1076 | 1645 | 1764 | 1972 | 2034 | 2378 | 96 | 204 | 77 |
| | PLO | 4 | 1116 | 1685 | 1804 | 2012 | 2074 | 2418 | 96 | 204 | 73 |
| 36 x 54B | PL | 4 | 1199 | 2156 | 2325 | 2630 | 2672 | 3105 | 96 | 204 | 87 |
| | PLO | 4 | 1239 | 2196 | 2365 | 2670 | 2712 | 3145 | 96 | 204 | 83 |
| 36 x 60B | PL | 4 | 1199 | 2156 | 2325 | 2630 | 2672 | 3105 | 96 | 204 | 87 |
| | PLO | 4 | 1239 | 2196 | 2365 | 2670 | 2712 | 3145 | 96 | 204 | 83 |
| 36 x 72B | PL | 4 | 1337 | 2395 | 2582 | 2908 | 3097 | 3641 | 96 | 204 | 100 |
| | PLO | 4 | 1377 | 2435 | 2622 | 2948 | 3137 | 3681 | 96 | 204 | 96 |



2448RE-PL



2448RE-PLO

STANDARD FEATURES

- Select from 15 standard laminates or choose any standard Wilsonart, Nevamar, Formica, Arborite and Pionite matte finish laminates at no upcharge. For other laminate please contact the factory for pricing.
- 9 standard veneer and hardwood edge stains. Stain-to-match available at no upcharge.
- Bases available in any Spectone color.
- Standard table height 29".
- All bases are standard with floor leveling glides.
- PL is constructed from 2.5" dia round steel tube, PLO is constructed from 3.5" x 2.5" OD oval steel tube.

OPTIONS

- Custom heights available.
- For applicable Power & Data modules, please see Table Accessories Price List.

HOW TO ORDER

1. Select Model
2. Select Base
3. Select Edge Style
4. Select Options
5. Select Top Finish
6. Select Edge Finish
7. Select Base Finish

Example: 3054B - PL - PVF -





BACK TO CONTENTS

POST LEGS TABLES GENERAL PURPOSE



| MODEL | BASES | | TOP SPECIFICATIONS | | | | | | OPTIONS | | LBS |
|---------------------------|---------------|------|--------------------|------|------|----------------|------|-------|---------|------|-----|
| | Code | Qty. | For Laminate Top | | | For Veneer Top | | | HARD | SOFT | |
| | | | SE | HF | HBV | HF2 | HF | HF2 | CASTERS | | |
| | | | PVF | HB | HBVR | HB2 | HB | HB2 | HARD | SOFT | |
| | | | 2MM | HBG | HBG | HKN4 | HBV | HKN4 | (HC) | (SC) | |
| | | | | | | HKNR4 | HBVR | HKNR4 | | | |
| | | | | | | HBG2 | HBG | HBG2 | | | |
| <i>Halfmoon</i> | | | | | | | | | | | |
| 24 x 48H | PL | 4 | 861 | 1375 | 1504 | 1660 | 1787 | 2079 | 96 | 204 | 58 |
| | PLO | 4 | 901 | 1415 | 1544 | 1700 | 1827 | 2119 | 96 | 204 | 54 |
| 30 x 60H | PL | 4 | 1076 | 1841 | 2018 | 2194 | 2414 | 2831 | 96 | 204 | 77 |
| | PLO | 4 | 1116 | 1881 | 2058 | 2234 | 2454 | 2871 | 96 | 204 | 73 |
| 36 x 72H | PL | 4 | 1337 | 2381 | 2612 | 2828 | 3185 | 3749 | 96 | 204 | 100 |
| | PLO | 4 | 1377 | 2421 | 2652 | 2868 | 3225 | 3789 | 96 | 204 | 96 |
| <i>Trapezoid</i> | | | | | | | | | | | |
| 30 x 60TP | PL | 4 | 1076 | 1547 | 1657 | 1846 | 1901 | 2220 | 96 | 204 | 77 |
| | PLO | 4 | 1116 | 1587 | 1697 | 1886 | 1941 | 2260 | 96 | 204 | 73 |
| 36 x 72TP | PL | 4 | 1337 | 1976 | 2120 | 2448 | 2530 | 2990 | 96 | 204 | 100 |
| | PLO | 4 | 1377 | 2016 | 2160 | 2488 | 2570 | 3030 | 96 | 204 | 96 |
| <i>Radius (connector)</i> | | | | | | | | | | | |
| 24 x 24 | 24RC90 | - | 395 | 717 | 810 | 929 | 952 | 1140 | | | 17 |
| 30 x 30 | 30RC90 | - | 504 | 948 | 1066 | 1195 | 1263 | 1515 | | | 27 |
| <i>Crescent</i> | | | | | | | | | | | |
| 30 x 36 | 3036CRC90-PL | 1 | 697 | 1383 | 1470 | 1538 | 1756 | 1995 | | | 38 |
| 36 x 42 | 3036CRC90-PLO | 1 | 707 | 1393 | 1480 | 1548 | 1766 | 2005 | | | 37 |
| | 3642CRC90-PL | 1 | 1060 | 1704 | 1823 | 1912 | 2212 | 2536 | | | 51 |
| | 3642CRC90-PLO | 1 | 1070 | 1714 | 1833 | 1922 | 2222 | 2546 | | | 50 |



2448RE-PL



2448RE-PLO

STANDARD FEATURES

- Select from 15 standard laminates or choose any standard Wilsonart, Nevamar, Formica, Arborite and Pionite matte finish laminates at no upcharge. For other laminate please contact the factory for pricing.
- 9 standard veneer and hardwood edge stains. Stain-to-match available at no upcharge.
- Bases available in any Spectone color.
- Standard table height 29".
- All bases are standard with floor leveling glides.
- PL is constructed from 2.5" dia round steel tube, PLO is constructed from 3.5" x 2.5" OD oval steel tube.

OPTIONS

- Custom heights available.
- For applicable Power & Data modules, please see Table Accessories Price List.

HOW TO ORDER

1. Select Model
2. Select Base
3. Select Edge Style
4. Select Options
5. Select Top Finish
6. Select Edge Finish
7. Select Base Finish

Example: 2448H - PL - PVF -





POST LEGS TABLES BOARDROOM



| MODEL | BASES | | TOP SPECIFICATIONS | | | | | | OPTIONS | LBS |
|------------------|-------|------|--------------------|--|--------------------|-------------------------------------|--------------------------------|-------------------------------------|---------|-----|
| | Code | Qty. | For Laminate Top | | | For Veneer Top | | | | |
| | | | SE PVF 2MM | HF HB PKNR ¹ PF ¹ | HBV HBVR HBG | HF2 HB2 HKN4 HKNR4 HBG2 | HF HB HBV HBVR HBG | HF2 HB2 HKN4 HKNR4 HBG2 | | |
| <i>Rectangle</i> | | | | | | | | | | |
| 42 x 96RE | PL | 5 | 2009 | 2919 | 3165 | 3414 | 3782 | 4494 | | 165 |
| | PLO | 5 | 2059 | 2969 | 3215 | 3464 | 3832 | 4544 | | 160 |
| | PLH | 5 | 2449 | 3359 | 3605 | 3854 | 4222 | 4934 | | 179 |
| 48 x 96RE | PL | 5 | 2009 | 2919 | 3165 | 3414 | 3782 | 4494 | | 165 |
| | PLO | 5 | 2059 | 2969 | 3215 | 3464 | 3832 | 4544 | | 160 |
| | PLH | 5 | 2449 | 3359 | 3605 | 3854 | 4222 | 4934 | | 179 |
| 48 x 120RE | PLH | 6 | 2993 | 4168 | 4446 | 5047 | 5135 | 5968 | | 234 |
| 48 x 144RE | PLH | 6 | 3389 | 5074 | 5441 | 6012 | 5876 | 6878 | | 268 |
| 48 x 168RE | PLH | 6 | 3893 | 5589 | 6008 | 6805 | 6621 | 7785 | | 302 |
| 60 x 120RE | PLH | 6 | 3477 | 5234 | 5618 | 6210 | 6069 | 7114 | | 276 |
| 60 x 144RE | PLH | 6 | 3925 | 6034 | 6493 | 7204 | 7036 | 8289 | | 318 |
| 60 x 168RE | PLH | 6 | 4375 | 6834 | 7368 | 8200 | 8003 | 9463 | | 360 |



¹ Exposed Baltic Birch plywood edge (PKNR, PF) can only be specified on tops up to 47-1/2" x 95-1/2". Clear finish only.



4296BTA-PL



4296BTA-PLO



4296BTA-PLH

STANDARD FEATURES

- Select from 15 standard laminates or choose any standard Wilsonart, Nevamar, Formica, Arborite and Pionite matte finish laminates at no upcharge. For other laminate please contact the factory for pricing.
- 9 standard veneer and hardwood edge stains. Stain-to-match available at no upcharge.
- Bases available in any Spectone color.
- Standard table height 29".
- All bases are standard with floor leveling glides.
- PL is constructed from 2.5" dia round steel tube, PLO from 3.5" x 2.5" OD oval steel tube, and PLH from 3.5" dia round steel tube.

OPTIONS

- Custom heights available.
- For applicable Power & Data modules, please see Table Accessories Price List.

HOW TO ORDER

1. Select Model
2. Select Base
3. Select Edge Style
4. Select Top Finish
5. Select Edge Finish
6. Select Base Finish

Example: 4296RE - PL - PVF





POST LEGS TABLES BOARDROOM



| MODEL | BASES | | TOP SPECIFICATIONS | | | | | | OPTIONS | LBS |
|------------------|-------|------|--------------------|----------|--------------------|-------------------------------------|--------------------------------|-------------------------------------|---------|-----|
| | Code | Qty. | For Laminate Top | | | For Veneer Top | | | | |
| | | | SE PVF 2MM | HF HB | HBV HBVR HBG | HF2 HB2 HKN4 HKNR4 HBG2 | HF HB HBV HBVR HBG | HF2 HB2 HKN4 HKNR4 HBG2 | | |
| <i>Racetrack</i> | | | | | | | | | | |
| 42 x 96RT | PL | 5 | 2029 | 3058 | 3309 | 3912 | 4338 | 5097 | | 165 |
| | PLO | 5 | 2079 | 3108 | 3359 | 3962 | 4388 | 5147 | | 160 |
| | PLH | 5 | 2469 | 3498 | 3749 | 4352 | 4778 | 5537 | | 179 |
| 48 x 96RT | PL | 5 | 2029 | 3058 | 3309 | 3912 | 4338 | 5097 | | 165 |
| | PLO | 5 | 2079 | 3108 | 3359 | 3962 | 4388 | 5147 | | 160 |
| | PLH | 5 | 2469 | 3498 | 3749 | 4352 | 4778 | 5537 | | 179 |
| 48 x 120RT | PLH | 6 | 3020 | 4652 | 4979 | 5810 | 5775 | 6662 | | 234 |
| 48 x 144RT | PLH | 6 | 3419 | 5452 | 5853 | 6883 | 6644 | 7720 | | 268 |
| 48 x 168RT | PLH | 6 | 3925 | 6136 | 6604 | 7748 | 7526 | 8773 | | 302 |
| 60 x 120RT | PLH | 6 | 3466 | 5506 | 5912 | 6956 | 6909 | 8022 | | 276 |
| 60 x 144RT | PLH | 6 | 3965 | 6506 | 7009 | 8299 | 7998 | 9342 | | 318 |
| 60 x 168RT | PLH | 6 | 4600 | 7365 | 7949 | 9375 | 9099 | 10657 | | 360 |



4296BTA-PL



4296BTA-PLO



4296BTA-PLH

STANDARD FEATURES

- Select from 15 standard laminates or choose any standard Wilsonart, Nevamar, Formica, Arborite and Pionite matte finish laminates at no upcharge. For other laminate please contact the factory for pricing.
- 9 standard veneer and hardwood edge stains. Stain-to-match available at no upcharge.
- Bases available in any Spectone color.
- Standard table height 29".
- All bases are standard with floor leveling glides.
- PL is constructed from 2.5" dia round steel tube, PLO from 3.5" x 2.5" OD oval steel tube, and PLH from 3.5" dia round steel tube.

OPTIONS

- Custom heights available.
- For applicable Power & Data modules, please see Table Accessories Price List.

HOW TO ORDER

1. Select Model
2. Select Base
3. Select Edge Style
4. Select Top Finish
5. Select Edge Finish
6. Select Base Finish

Example: 4296RT - PL - PVF





POST LEGS TABLES BOARDROOM



| MODEL | BASES | | TOP SPECIFICATIONS | | | | | | OPTIONS | LBS |
|------------------|-------|------|--------------------|----------|--------------------|-------------------------------------|--------------------------------|-------------------------------------|---------|-----|
| | Code | Qty. | For Laminate Top | | | For Veneer Top | | | | |
| | | | SE PVF 2MM | HF HB | HBV HBVR HBG | HF2 HB2 HKN4 HKNR4 HBG2 | HF HB HBV HBVR HBG | HF2 HB2 HKN4 HKNR4 HBG2 | | |
| <i>Boatshape</i> | | | | | | | | | | |
| 42 x 96BT | PL | 5 | 2029 | 3760 | 4082 | 4414 | 4885 | 5299 | | 165 |
| | PLO | 5 | 2079 | 3810 | 4132 | 4464 | 4935 | 5349 | | 160 |
| | PLH | 5 | 2469 | 4200 | 4522 | 4854 | 5325 | 5739 | | 179 |
| 48 x 96BT | PL | 5 | 2029 | 3760 | 4082 | 4414 | 4885 | 5299 | | 165 |
| | PLO | 5 | 2079 | 3810 | 4132 | 4464 | 4935 | 5349 | | 160 |
| | PLH | 5 | 2469 | 4200 | 4522 | 4854 | 5325 | 5739 | | 179 |
| 48 x 120BT | PLH | 6 | 3020 | 5421 | 5820 | 6242 | 6421 | 6900 | | 234 |
| 48 x 144BT | PLH | 6 | 3419 | 6222 | 6698 | 7204 | 7842 | 8277 | | 268 |
| 48 x 168BT | PLH | 6 | 3925 | 6987 | 7542 | 8126 | 8424 | 9096 | | 302 |
| 60 x 120BT | PLH | 6 | 3466 | 6465 | 6968 | 7494 | 7720 | 8314 | | 276 |
| 60 x 144BT | PLH | 6 | 3965 | 7470 | 8065 | 8698 | 9493 | 10039 | | 318 |
| 60 x 168BT | PLH | 6 | 4600 | 8428 | 9119 | 9850 | 10220 | 11062 | | 360 |



4296BTA-PL



4296BTA-PL0



4296BTA-PLH

STANDARD FEATURES

- Select from 15 standard laminates or choose any standard Wilsonart, Nevamar, Formica, Arborite and Pionite matte finish laminates at no upcharge. For other laminate please contact the factory for pricing.
- 9 standard veneer and hardwood edge stains. Stain-to-match available at no upcharge.
- Bases available in any Spectone color.
- Standard table height 29".
- All bases are standard with floor leveling glides.
- PL is constructed from 2.5" dia round steel tube, PLO from 3.5" x 2.5" OD oval steel tube, and PLH from 3.5" dia round steel tube.

OPTIONS

- Custom heights available.
- For applicable Power & Data modules, please see Table Accessories Price List.

HOW TO ORDER

1. Select Model
2. Select Base
3. Select Edge Style
4. Select Top Finish
5. Select Edge Finish
6. Select Base Finish

Example: 4296BT - PL - PVF





BACK TO CONTENTS

POST LEGS TABLES BOARDROOM



| MODEL | BASES | | TOP SPECIFICATIONS | | | | | | OPTIONS | LBS |
|------------------|-------|------|--------------------|----------|--------------------|-------------------------------------|--------------------------------|-------------------------------------|---------|-----|
| | Code | Qty. | For Laminate Top | | | For Veneer Top | | | | |
| | | | SE PVF 2MM | HF HB | HBV HBVR HBG | HF2 HB2 HKN4 HKNR4 HBG2 | HF HB HBV HBVR HBG | HF2 HB2 HKN4 HKNR4 HBG2 | | |
| <i>Boatshape</i> | | | | | | | | | | |
| <i>Arc Ends</i> | | | | | | | | | | |
| 42 x 96BTA | PL | 5 | 2205 | 4311 | 4635 | 4969 | 5437 | 5851 | | 165 |
| | PLO | 5 | 2255 | 4361 | 4685 | 5019 | 5487 | 5901 | | 160 |
| | PLH | 5 | 2645 | 4751 | 5075 | 5409 | 5877 | 6291 | | 179 |
| 48 x 96BTA | PL | 5 | 2205 | 4311 | 4635 | 4969 | 5437 | 5851 | | 165 |
| | PLO | 5 | 2255 | 4361 | 4685 | 5019 | 5487 | 5901 | | 160 |
| | PLH | 5 | 2645 | 4751 | 5075 | 5409 | 5877 | 6291 | | 179 |
| 48 x 120BTA | PLH | 6 | 3195 | 5975 | 6375 | 6797 | 6976 | 7451 | | 234 |
| 48 x 144BTA | PLH | 6 | 3595 | 6773 | 7253 | 7759 | 8393 | 8831 | | 268 |
| 48 x 168BTA | PLH | 6 | 4102 | 7542 | 8097 | 8681 | 8977 | 9652 | | 302 |
| 60 x 120BTA | PLH | 6 | 3687 | 7160 | 7659 | 8186 | 8410 | 9005 | | 276 |
| 60 x 144BTA | PLH | 6 | 4184 | 8159 | 8758 | 9389 | 10185 | 10728 | | 318 |
| 60 x 168BTA | PLH | 6 | 4819 | 9119 | 9811 | 10540 | 10913 | 11757 | | 360 |



4296BTA-PL



4296BTA-PLO



4296BTA-PLH

STANDARD FEATURES

- Select from 15 standard laminates or choose any standard Wilsonart, Nevamar, Formica, Arborite and Pionite matte finish laminates at no upcharge. For other laminate please contact the factory for pricing.
- 9 standard veneer and hardwood edge stains. Stain-to-match available at no upcharge.
- Bases available in any Spectone color.
- Standard table height 29".
- All bases are standard with floor leveling glides.
- PL is constructed from 2.5" dia round steel tube, PLO from 3.5" x 2.5" OD oval steel tube, and PLH from 3.5" dia round steel tube.

OPTIONS

- Custom heights available.
- For applicable Power & Data modules, please see Table Accessories Price List.

HOW TO ORDER

1. Select Model
2. Select Base
3. Select Edge Style
4. Select Top Finish
5. Select Edge Finish
6. Select Base Finish

Example: 4296BTA - PL - PVF



SIDEKICK TABLES



PRODUCT CODE

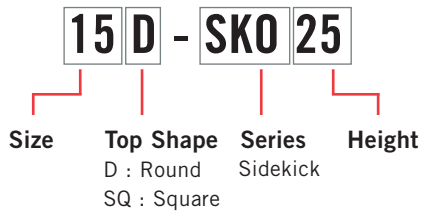

OPTIONS

UPHOLSTERY CAP



BASE SHAPE*



*Table top shape determines base shape.

FINISHES

LAMINATE

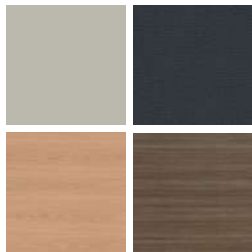

Select from 15 standard laminates or choose any standard Wilsonart, Nevamar, Formica, Arborite and Pionite matte finish laminates at no upcharge

VENEER



Select from one of our 9 standard wood stains or stain-to-match at no upcharge

BASE



Select from one of our 76 standard Spectone colors

EDGE



See Spectone Card or specfurniture.com/materials/finishes for a complete list of finish options and colors.

SIDEKICK TABLES

HOW TO ORDER

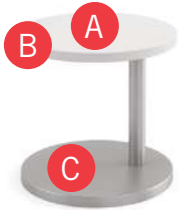

Specify Top Size and Shape

- A** Specify Top Type and Finish
For Laminate Top: Manufacturer, Laminate Name, Laminate Code
For Veneer Top: Wood Stain
- B** Specify Edge Type, (for hardwood: Style), and Finish
PVC/2mm/Self Edge/Exposed Baltic Birch Plywood/Hardwood
- C** Specify Base Style and Finish

Optional: Upholstery Cap

Restrictions may apply. See price list tables below for more information.

| Top Size and Shape | Top Type and Finish | Edge Type and Finish | Base Style and Finish |
|--------------------|--|----------------------|-----------------------|
| 18D, Round | Laminate, Wilsonart, Designer White, D354-60 | 2mm Bio, RAL 9016 | SKO22, Silver |



EDGE PROFILES

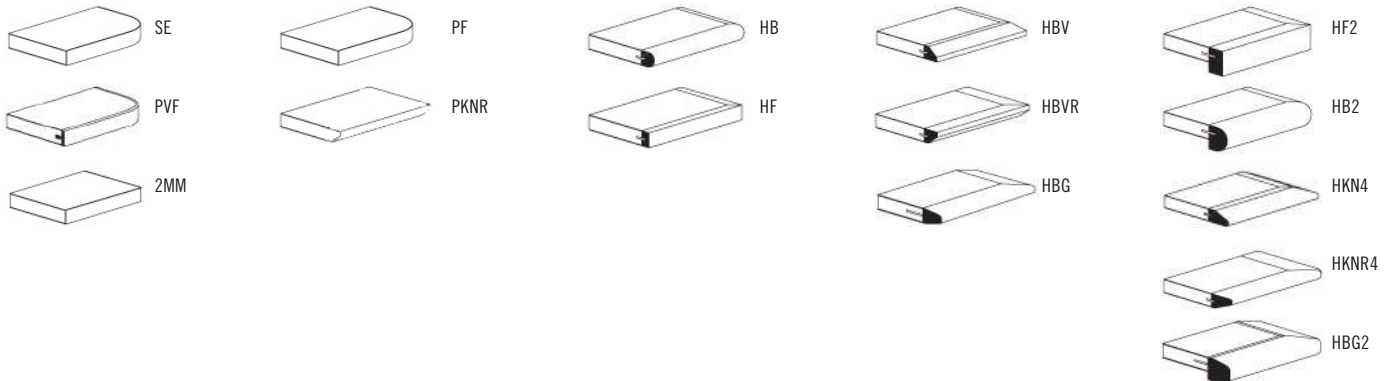



BACK TO CONTENTS

SIDEKICK TABLES OCCASIONAL



| SIZE | MODEL | DESCRIPTION | BASE | TOP SPECIFICATIONS | | | | | | OPTION | LBS |
|---------------|------------|--|------|--------------------|--|--------------------|-------------------------------------|------------------------|-------------------------------------|------------------------------|-----|
| | | | | For Laminate Top | | | For Veneer Top | | | | |
| | Code | | Qty. | SE PVF 2MM | HF HB PKNR ¹ PF ¹ | HBV HBVR HBG | HF2 HB2 HKN4 HKNR4 HBG2 | HF HB HBV HBG | HF2 HB2 HKN4 HKNR4 HBG2 | UPHOLSTERY CAP Add | |
| <i>Round</i> | | | | | | | | | | | |
| 15 | 15D-SK018 | 15" Round Top with 18" High Offset Base | 1 | 642 | 994 | 1030 | 1134 | 1190 | 1297 | 51 | 26 |
| | 15D-SK022 | 15" Round Top with 22" High Offset Base | 1 | 642 | 994 | 1030 | 1134 | 1190 | 1297 | 51 | 26 |
| | 15D-SK025 | 15" Round Top with 25" High Offset Base | 1 | 642 | 994 | 1030 | 1134 | 1190 | 1297 | | 26 |
| 18 | 18D-SK018 | 18" Round Top with 18" High Offset Base | 1 | 708 | 1080 | 1117 | 1226 | 1285 | 1397 | 51 | 33 |
| | 18D-SK022 | 18" Round Top with 22" High Offset Base | 1 | 708 | 1080 | 1117 | 1226 | 1285 | 1397 | 51 | 33 |
| | 18D-SK025 | 18" Round Top with 25" High Offset Base | 1 | 708 | 1080 | 1117 | 1226 | 1285 | 1397 | | 33 |
| 22 | 22D-SK018 | 22" Round Top with 18" High Offset Base | 1 | 821 | 1181 | 1218 | 1327 | 1386 | 1498 | | 44 |
| | 22D-SK022 | 22" Round Top with 22" High Offset Base | 1 | 821 | 1181 | 1218 | 1327 | 1386 | 1498 | | 44 |
| | 22D-SK025 | 22" Round Top with 25" High Offset Base | 1 | 821 | 1181 | 1218 | 1327 | 1386 | 1498 | | 44 |
| <i>Square</i> | | | | | | | | | | | |
| 15 | 15SQ-SK018 | 15" Square Top with 18" High Offset Base | 1 | 608 | 808 | 843 | 908 | 954 | 1113 | | 26 |
| | 15SQ-SK022 | 15" Square Top with 22" High Offset Base | 1 | 608 | 808 | 843 | 908 | 954 | 1113 | | 27 |
| | 15SQ-SK025 | 15" Square Top with 25" High Offset Base | 1 | 608 | 808 | 843 | 908 | 954 | 1113 | | 27 |
| 18 | 18SQ-SK018 | 18" Square Top with 18" High Offset Base | 1 | 673 | 879 | 916 | 984 | 1034 | 1201 | | 34 |
| | 18SQ-SK022 | 18" Square Top with 22" High Offset Base | 1 | 673 | 879 | 916 | 984 | 1034 | 1201 | | 35 |
| | 18SQ-SK025 | 18" Square Top with 25" High Offset Base | 1 | 673 | 879 | 916 | 984 | 1034 | 1201 | | 35 |
| 22 | 22SQ-SK018 | 22" Square Top with 18" High Offset Base | 1 | 786 | 982 | 1019 | 1087 | 1137 | 1304 | | 47 |
| | 22SQ-SK022 | 22" Square Top with 22" High Offset Base | 1 | 786 | 982 | 1019 | 1087 | 1137 | 1304 | | 47 |
| | 22SQ-SK025 | 22" Square Top with 25" High Offset Base | 1 | 786 | 982 | 1019 | 1087 | 1137 | 1304 | | 48 |

¹ Exposed Baltic Birch plywood edge (PKNR, PF) can only be specified on square tops up to 47-1/2" x 95-1/2". Clear finish only.



STANDARD FEATURES

- Available in 15", 18" and 22" round or square tops at 18", 22" and 25" heights.
- Round Base and offset column is used with round tops.
- Square Base and offset column is used with square tops.
- Select from 15 standard laminates or choose any standard Wilsonart, Nevamar, Formica, Arborite and Pionite matte finish laminates at no upcharge. For other laminate please contact the factory for pricing.
- 9 standard veneer and hardwood edge stains. Stain-to-match available at no upcharge.
- Base and column available in any of 76 Spectone colors.
- Levelling glides
- Exceeds BIFMA Seating Durability Test to 300 lbs.

OPTION

- Upholstery cap is available on some models.

HOW TO ORDER

1. Select Model
2. Select Edge Style
3. Select Option
4. Select Top Finish
5. Select Edge Finish
6. Select Base Finish

Example: 15D-SK018-PVF-



TAILGATE TABLES



PRODUCT CODE



| Series | Top Size | Top Shape | Series | Base | Finish |
|--------------|----------|---------------------|--------------|------------------------|--------------|
| Tailgate | Width x | B : Bullet | Tailgate | RE : Rectangle Plinth | L : Laminate |
| Freestanding | Length | RE : Rectangle | Freestanding | SQ : Square Plinth | V : Veneer |
| | | RT : Racetrack | | MNT2 : Manhattan Rect | |
| | | BT : Boatshape | | Double Column | |
| | | REA : Rectangle | | MRT2 : Manhattan Round | |
| | | Arc Ends | | Double Column | |
| | | BTA : Boatshape Arc | | | |
| | | Ends | | | |
| | | EL : Ellipse | | | |
| | | VC : Video | | | |
| | | Conference | | | |
| | | VCA : Video | | | |
| | | Conference Arc Ends | | | |

OPTIONS

BASES



Manhattan Round Double Column Manhattan Rectangular Double Column Plinth Base

VERTICAL WIRE MANAGER



Oval Vertical Wire Manager, with hinge door (shown on both columns) Rectangular Vertical Wire Manager, with removable door (shown on both columns)

FINISHES

LAMINATE

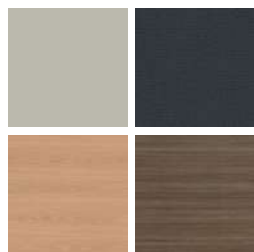

Select from 15 standard laminates or choose any standard Wilsonart, Nevamar, Formica, Arborite and Pionite matte finish laminates at no upcharge

VENEER

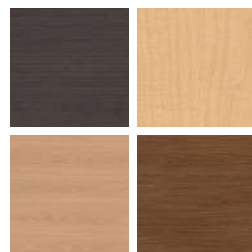

Select from one of our 9 standard wood stains or stain-to-match at no upcharge

BASE



Select from one of our 76 standard Spectone colors

EDGE



See Spectone Card or specfurniture.com/materials/finishes for a complete list of finish options and colors.

TAILGATE TABLES

HOW TO ORDER



Specify Series, Top Size (Width x Length) and Shape

- A** Specify Top Type and Finish
For Laminate Top: Manufacturer, Laminate Name, Laminate Code
For Veneer Top: Wood Stain
- B** Specify Edge Type, (for hardwood: Style), and Finish
PVC Flat/2mm Bio/2mm PVC Woodgrain/Self Edge/Hardwood
- C** Specify Base Style and Finish
For Laminate Base: Manufacturer, Laminate Name, Laminate Code
For Veneer Base: Wood Stain
For Metal Base: RAL Finish
 Optional: Vertical Wire Managers, Power and Data Modules

| Series, Top Size and Shape | Top Finish | Edge Finish | Base Style and Finish | VWM Finish (if applicable) | Trough Size and Finish |
|----------------------------|---------------------------------|--|---------------------------------------|----------------------------|------------------------|
| TG, 55 x 66, Rectangle | Laminate, Arborite, Brown Sugar | Hardwood, HF, Custom Brown Sugar Stain | TGRE-L, Veneer, Arborite, Brown Sugar | n/a | 40", Silver |

EDGE PROFILES

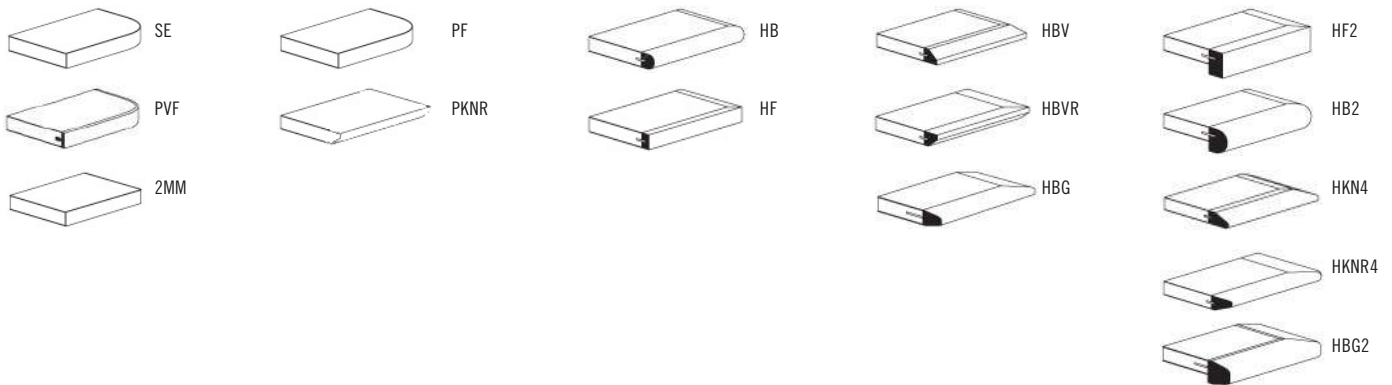
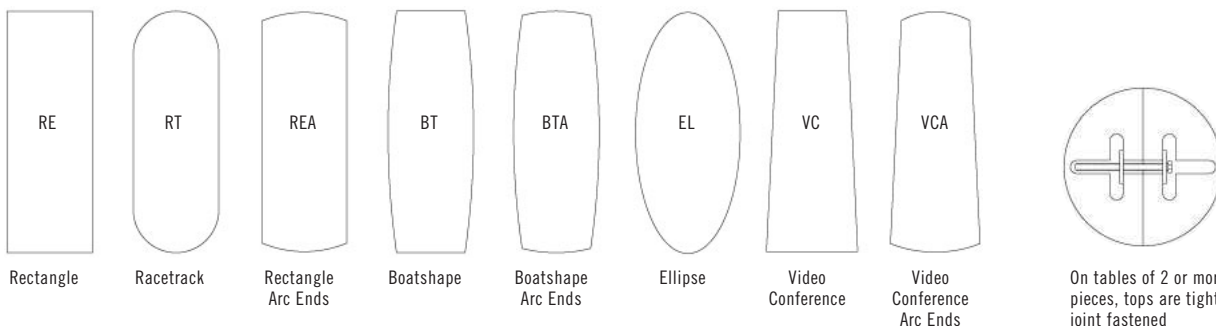

TABLE TOPS

On one-piece tabletops, grain direction runs lengthwise. On tabletops of two or more pieces, grain direction runs from side-to-side, as standard.





BACK TO CONTENTS

TAILGATE TABLES

TABLETOP

| SIZE | TABLETOPS | | TOP AND EDGE SPECIFICATIONS | | | | | | TROUGHS | | BASES | | SEATS | LBS |
|---------------|-----------|--------------------|-----------------------------|-------|--------------|-------------------------|---------------------------------------|-------------------------|-------------------|---------------------|--------------------------|-------------|-------|-----------------|
| | Model | Number of Sections | SE PVF 2MM | HF HB | HBV HBVR HBG | HF2 HB2 HKN4 HKNR4 HBG2 | For Veneer Top HF HB HB2 HBV HBVR HBG | HF2 HB2 HKN4 HKNR4 HBG2 | Number of Troughs | Length of Trough(s) | Number of Bases Required | TGRE TGMNT2 | TGSQ | Number of Seats |
| <i>Bullet</i> | | | | | | | | | | | | | | |
| 48 x 66 | TG4866B | 1 | 2253 | 2950 | 3202 | 3538 | 3622 | 4182 | 1 | 40 | 2 | 2 | 4 | 92 |
| 48 x 72 | TG4872B | 1 | 2362 | 3124 | 3400 | 3764 | 3855 | 4466 | 1 | 40 | 2 | 2 | 4 | 101 |
| 48 x 84 | TG4884B | 1 | 2833 | 3722 | 4043 | 4469 | 4575 | 5286 | 1 | 52 | 2 | 2 | 6 | 118 |
| 48 x 96 | TG4896B | 1 | 3052 | 4067 | 4434 | 4921 | 5043 | 5855 | 1 | 52 | 2 | 2 | 8 | 134 |
| 60 x 66 | TG6066B | 1 | 2427 | 3228 | 3517 | 3902 | 3996 | 4637 | 1 | 40 | 2 | 2 | 4 | 116 |
| 60 x 72 | TG6072B | 1 | 2552 | 3426 | 3741 | 4159 | 4264 | 4963 | 1 | 40 | 2 | 2 | 4 | 126 |
| 60 x 84 | TG6084B | 1 | 3056 | 4074 | 4441 | 4931 | 5053 | 5867 | 1 | 52 | 2 | 2 | 6 | 147 |
| 60 x 96 | TG6096B | 1 | 3304 | 4470 | 4889 | 5448 | 5588 | 6520 | 1 | 52 | 2 | 2 | 8 | 168 |

Price of top includes troughs and power duplexes. Number of duplexes varies depending on trough size and number of troughs per table. Trough door opens and closes from either side. An open perimeter around each side of the trough door allows the door to be closed while laptops and other items are plugged in.



BASES

| MODEL | BASE SHAPE | LIST PRICE | LBS |
|--------------|---|------------|-----|
| TGRE-L | Rectangle Plinth, 11" x 22" - Laminate | 977 | 60 |
| TGRE-V | Rectangle Plinth, 11" x 22" - Veneer | 1151 | 60 |
| TGSQ-L | Square Plinth, 22" x 22" - Laminate | 977 | 70 |
| TGSQ-V | Square Plinth, 22" x 22" - Veneer | 1151 | 70 |
| TGMNT2 | Manhattan Round Double Column | 387 | 22 |
| TGMRT2 | Manhattan Rectangular Double Column | 426 | 22 |
| TGMNT2-VWM | Manhattan Round Double Column with 1 Oval Vertical Wire Manager | 574 | 27 |
| TGMNT2-RVWM | Manhattan Round Double Column with 1 Rectangular Vertical Wire Manager | 574 | 27 |
| TGMNT2-VWM2 | Manhattan Round Double Column with 2 Oval Vertical Wire Managers | 763 | 32 |
| TGMNT2-RVWM2 | Manhattan Round Double Column with 2 Rectangular Vertical Wire Managers | 763 | 32 |

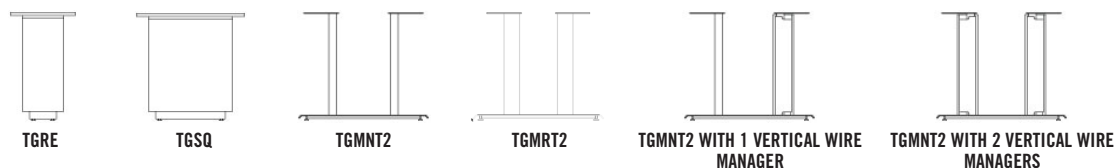

STANDARD FEATURES

- Select from 15 standard laminates or choose any standard Wilsonart, Nevamar, Formica, Arborite and Pionite matte finish laminates at no upcharge. For other laminate please contact the factory for pricing.
- 9 standard veneer and hardwood edge stains. Stain-to-match available at no upcharge.
- Standard with leveling glides.
- Plinth bases are standard with touch latch removable door.

- Plinth bases are standard with kickplate, finished in HOMAPAL 441 Brushed Natural Aluminum.
- Metal bases available in any Spectone color.
- Standard 29" table height.

OPTIONS

- For additional Power & Data modules, please see Table Accessories Price List.
- Cutout for wire pass-through at the bottom of Tailgate bases must be specified if required.



HOW TO ORDER

1. Select Top Size
2. Select Top Finish
3. Select Edge Style & Finish
4. Select Base
5. Select Base Finish

Example: 4896B - MNT2 -





TAILGATE TABLES

TABLETOP

BACK TO CONTENTS



| SIZE | TABLETOPS | | TOP AND EDGE SPECIFICATIONS | | | | | | TROUGHS | | BASES | | SEATS | LBS |
|------------------|-------------------|--------------------|-----------------------------|-------|-------|----------------|--------|-------|-------------------|---------------------|--------------------------|---|-----------------|-----|
| | Model | Number of Sections | For Laminate Top | | | For Veneer Top | | | Number of Troughs | Length of Trough(s) | Number of Bases Required | | Number of Seats | |
| SE | HF | HBV | HF2 | HF | HF2 | | TGRE | TGSQ | | | | | | |
| PVF | HB | HBVR | HB2 | HB | HB2 | | TGMNT2 | | | | | | | |
| 2MM | PKNR ¹ | HVG | HKN4 | HBV | HKN4 | | | | | | | | | |
| | PF ¹ | | HKNR4 | HBVR | HKNR4 | | | | | | | | | |
| | | | HVG2 | HVG | HVG2 | | | | | | | | | |
| <i>Rectangle</i> | | | | | | | | | | | | | | |
| 48 x 96 | TG4896RE | 1 | 2582 | 3492 | 3738 | 3987 | 4355 | 5067 | 1 | 52 | 2 | 2 | 8 | 135 |
| 48 x 120 | TG48120RE | 2 | 2991 | 4166 | 4444 | 5045 | 5133 | 5966 | 1 | 76 | 3 | 2 | 10 | 168 |
| 48 x 144 | TG48144RE | 2 | 3975 | 5660 | 6027 | 6598 | 6462 | 7464 | 2 | 40 | 3 | 3 | 10 | 202 |
| 48 x 168 | TG48168RE | 2 | 4983 | 6679 | 7098 | 7895 | 7711 | 8875 | 2 | 52 | 3 | 3 | 12 | 236 |
| 48 x 192 | TG48192RE | 2 | 5306 | 7515 | 8023 | 9160 | 8772 | 10164 | 2 | 52 | 3 | 3 | 14 | 269 |
| 48 x 216 | TG48216RE | 2 | 6065 | 8252 | 8812 | 10022 | 9653 | 11223 | 2 | 76 | 3 | 3 | 14 | 303 |
| 60 x 120 | TG60120RE | 2 | 3475 | 5232 | 5616 | 6208 | 6067 | 7112 | 1 | 76 | 3 | 2 | 10 | 210 |
| 60 x 144 | TG60144RE | 2 | 4511 | 6620 | 7079 | 7790 | 7622 | 8875 | 2 | 40 | 3 | 3 | 12 | 252 |
| 60 x 168 | TG60168RE | 2 | 5465 | 7924 | 8458 | 9290 | 9093 | 10553 | 2 | 52 | 3 | 3 | 12 | 294 |
| 60 x 192 | TG60192RE | 2 | 6096 | 9044 | 9683 | 10681 | 10446 | 12200 | 2 | 52 | 3 | 3 | 14 | 336 |
| 60 x 216 | TG60216RE | 2 | 6707 | 10026 | 10748 | 11868 | 11603 | 13573 | 2 | 76 | 3 | 3 | 16 | 378 |

Price of top includes troughs and power duplexes. Number of duplexes varies depending on trough size and number of troughs per table. Trough door opens and closes from either side. An open perimeter around each side of the trough door allows the door to be closed while laptops and other items are plugged in.

¹ Exposed Baltic Birch plywood edge (PKNR, PF) can only be specified on square tops up to 47-1/2" x 95-1/2". Clear finish only.

BASES

| MODEL | BASE SHAPE | LIST PRICE | LBS |
|--------------|---|------------|-----|
| TGRE-L | Rectangle Plinth, 11" x 22" - Laminate | 977 | 60 |
| TGRE-V | Rectangle Plinth, 11" x 22" - Veneer | 1151 | 60 |
| TGSQ-L | Square Plinth, 22" x 22" - Laminate | 977 | 70 |
| TGSQ-V | Square Plinth, 22" x 22" - Veneer | 1151 | 70 |
| TGMNT2 | Manhattan Round Double Column | 387 | 22 |
| TGMRT2 | Manhattan Rectangular Double Column | 426 | 22 |
| TGMNT2-VWM | Manhattan Round Double Column with 1 Oval Vertical Wire Manager | 574 | 27 |
| TGMNT2-RVWM | Manhattan Round Double Column with 1 Rectangular Vertical Wire Manager | 574 | 27 |
| TGMNT2-VWM2 | Manhattan Round Double Column with 2 Oval Vertical Wire Managers | 763 | 32 |
| TGMNT2-RVWM2 | Manhattan Round Double Column with 2 Rectangular Vertical Wire Managers | 763 | 32 |

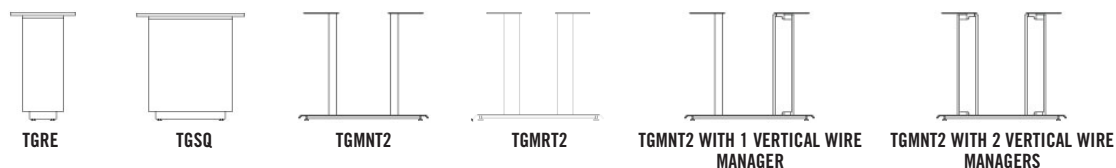

STANDARD FEATURES

- Select from 15 standard laminates or choose any standard Wilsonart, Nevamar, Formica, Arborite and Pionite matte finish laminates at no upcharge. For other laminate please contact the factory for pricing.
- 9 standard veneer and hardwood edge stains. Stain-to-match available at no upcharge.
- Standard with leveling glides.
- Plinth bases are standard with touch latch removable door.

- Plinth bases are standard with kickplate, finished in HOMAPAL 441 Brushed Natural Aluminum.
- Metal bases available in any Spectone color.
- Standard 29" table height.

OPTIONS

- For additional Power & Data modules, please see Table Accessories Price List.
- Cutout for wire pass-through at the bottom of Tailgate bases must be specified if required.

HOW TO ORDER

1. Select Top Size
2. Select Top Finish
3. Select Edge Style & Finish
4. Select Base
5. Select Base Finish

Example: 4896RE - MNT2 -





TAILGATE TABLES

TABLETOP



| SIZE | TABLETOPS | | TOP AND EDGE SPECIFICATIONS | | | | | | TROUGHS | | BASES | | SEATS | LBS |
|---------------------------|------------|--------------------|-----------------------------|-------|--------------|-------------------------|-----------------------------------|-------------------------|-------------------|---------------------|--------------------------|-------------|-------|-----------------|
| | Model | Number of Sections | SE PVF 2MM | HF HB | HBV HBVR HBG | HF2 HB2 HKN4 HKNR4 HBG2 | For Veneer Top HF HB HBV HBVR HBG | HF2 HB2 HKN4 HKNR4 HBG2 | Number of Troughs | Length of Trough(s) | Number of Bases Required | TGRE TGMNT2 | TGSQ | Number of Seats |
| <i>Rectangle Arc Ends</i> | | | | | | | | | | | | | | |
| 48 x 96 | TG4896REA | 1 | 2602 | 3631 | 3882 | 4485 | 4911 | 5670 | 1 | 52 | 2 | 2 | 8 | 135 |
| 48 x 120 | TG48120REA | 2 | 3018 | 4650 | 4977 | 5808 | 5773 | 6660 | 1 | 76 | 3 | 2 | 10 | 168 |
| 48 x 144 | TG48144REA | 2 | 4005 | 6038 | 6439 | 7469 | 7230 | 8306 | 2 | 40 | 3 | 3 | 10 | 202 |
| 48 x 168 | TG48168REA | 2 | 5015 | 7226 | 7694 | 8838 | 8616 | 9863 | 2 | 52 | 3 | 3 | 12 | 236 |
| 48 x 192 | TG48192REA | 2 | 5204 | 8090 | 8647 | 9750 | 10044 | 10918 | 2 | 52 | 3 | 3 | 14 | 269 |
| 48 x 216 | TG48216REA | 2 | 6065 | 8932 | 9560 | 10926 | 11263 | 12113 | 2 | 76 | 3 | 3 | 14 | 303 |
| 60 x 120 | TG60120REA | 2 | 3464 | 5504 | 5910 | 6954 | 6907 | 8020 | 1 | 76 | 3 | 2 | 10 | 210 |
| 60 x 144 | TG60144REA | 2 | 4551 | 7092 | 7595 | 8885 | 8584 | 9928 | 2 | 40 | 3 | 3 | 12 | 252 |
| 60 x 168 | TG60168REA | 2 | 5690 | 8455 | 9039 | 10465 | 10189 | 11747 | 2 | 52 | 3 | 3 | 12 | 294 |
| 60 x 192 | TG60192REA | 2 | 6361 | 9680 | 10383 | 12094 | 12486 | 13633 | 2 | 52 | 3 | 3 | 14 | 336 |
| 60 x 216 | TG60216REA | 2 | 7008 | 10740 | 11531 | 13457 | 13897 | 15187 | 2 | 76 | 3 | 3 | 16 | 378 |

Price of top includes troughs and power duplexes. Number of duplexes varies depending on trough size and number of troughs per table. Trough door opens and closes from either side. An open perimeter around each side of the trough door allows the door to be closed while laptops and other items are plugged in.

BASES

| MODEL | BASE SHAPE | LIST PRICE | LBS |
|--------------|---|------------|-----|
| TGRE-L | Rectangle Plinth, 11" x 22" - Laminate | 977 | 60 |
| TGRE-V | Rectangle Plinth, 11" x 22" - Veneer | 1151 | 60 |
| TGSQ-L | Square Plinth, 22" x 22" - Laminate | 977 | 70 |
| TGSQ-V | Square Plinth, 22" x 22" - Veneer | 1151 | 70 |
| TGMNT2 | Manhattan Round Double Column | 387 | 22 |
| TGMRT2 | Manhattan Rectangular Double Column | 426 | 22 |
| TGMNT2-VWM | Manhattan Round Double Column with 1 Oval Vertical Wire Manager | 574 | 27 |
| TGMNT2-RVWM | Manhattan Round Double Column with 1 Rectangular Vertical Wire Manager | 574 | 27 |
| TGMNT2-VWM2 | Manhattan Round Double Column with 2 Oval Vertical Wire Managers | 763 | 32 |
| TGMNT2-RVWM2 | Manhattan Round Double Column with 2 Rectangular Vertical Wire Managers | 763 | 32 |



TGRE

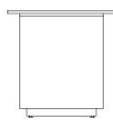

TGSQ

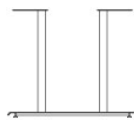

TGMNT2

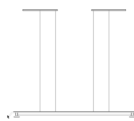

TGMRT2

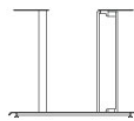

TGMNT2 WITH 1 VERTICAL WIRE MANAGER

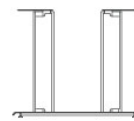

TGMNT2 WITH 2 VERTICAL WIRE MANAGERS

STANDARD FEATURES

- Select from 15 standard laminates or choose any standard Wilsonart, Nevamar, Formica, Arborite and Pionite matte finish laminates at no upcharge. For other laminate please contact the factory for pricing.
- 9 standard veneer and hardwood edge stains. Stain-to-match available at no upcharge.
- Standard with leveling glides.
- Plinth bases are standard with touch latch removable door.

- Plinth bases are standard with kickplate, finished in HOMAPAL 441 Brushed Natural Aluminum.
- Metal bases available in any Spectone color.
- Standard 29" table height.

OPTIONS

- For additional Power & Data modules, please see Table Accessories Price List.
- Cutout for wire pass-through at the bottom of Tailgate bases must be specified if required.



HOW TO ORDER

1. Select Top Size
2. Select Top Finish
3. Select Edge Style & Finish
4. Select Base
5. Select Base Finish

Example: 4896REA - MNT2 -





TAILGATE TABLES

TABLETOP

BACK TO CONTENTS



| SIZE | TABLETOPS | | TOP AND EDGE SPECIFICATIONS | | | | | | TROUGHS | | BASES | | SEATS | LBS |
|------------------|-----------|--------------------|-----------------------------|-------|--------------|-------------------------|--|-------------------|---------------------|--------------------------|-----------------|---|-------|-----|
| | Model | Number of Sections | SE PVF 2MM | HF HB | HBV HBVR HBG | HF2 HB2 HKN4 HKNR4 HBG2 | For Veneer Top HF HB HB2 HKN4 HBVR HKNR4 HBG2 | Number of Troughs | Length of Trough(s) | Number of Bases Required | Number of Seats | | | |
| | | | | TGRE | | TGSQ | | | | | | | | |
| <i>Racetrack</i> | | | | | | | | | | | | | | |
| 48 x 96 | TG4896RT | 1 | 2602 | 3631 | 3882 | 4485 | 4911 | 5670 | 1 | 52 | 2 | 2 | 8 | 135 |
| 48 x 120 | TG48120RT | 2 | 3018 | 4650 | 4977 | 5808 | 5773 | 6660 | 1 | 76 | 3 | 2 | 10 | 168 |
| 48 x 144 | TG48144RT | 2 | 4005 | 6038 | 6439 | 7469 | 7230 | 8306 | 2 | 40 | 3 | 3 | 10 | 202 |
| 48 x 168 | TG48168RT | 2 | 5015 | 7226 | 7694 | 8838 | 8616 | 9863 | 2 | 52 | 3 | 3 | 12 | 236 |
| 48 x 192 | TG48192RT | 2 | 5204 | 8090 | 8647 | 9750 | 10044 | 10918 | 2 | 52 | 3 | 3 | 14 | 269 |
| 48 x 216 | TG48216RT | 2 | 6065 | 8932 | 9560 | 10926 | 11263 | 12113 | 2 | 76 | 3 | 3 | 14 | 303 |
| 60 x 120 | TG60120RT | 2 | 3464 | 5504 | 5910 | 6954 | 6907 | 8020 | 1 | 76 | 3 | 2 | 10 | 210 |
| 60 x 144 | TG60144RT | 2 | 4551 | 7092 | 7595 | 8885 | 8584 | 9928 | 2 | 40 | 3 | 3 | 12 | 252 |
| 60 x 168 | TG60168RT | 2 | 5690 | 8455 | 9039 | 10465 | 10189 | 11747 | 2 | 52 | 3 | 3 | 12 | 294 |
| 60 x 192 | TG60192RT | 2 | 6361 | 9680 | 10383 | 12094 | 12486 | 13633 | 2 | 52 | 3 | 3 | 14 | 336 |
| 60 x 216 | TG60216RT | 2 | 7008 | 10740 | 11531 | 13457 | 13897 | 15187 | 2 | 76 | 3 | 3 | 16 | 378 |

Price of top includes troughs and power duplexes. Number of duplexes varies depending on trough size and number of troughs per table. Trough door opens and closes from either side. An open perimeter around each side of the trough door allows the door to be closed while laptops and other items are plugged in.

BASES

| MODEL | BASE SHAPE | LIST PRICE | LBS |
|--------------|---|------------|-----|
| TGRE-L | Rectangle Plinth, 11" x 22" - Laminate | 977 | 60 |
| TGRE-V | Rectangle Plinth, 11" x 22" - Veneer | 1151 | 60 |
| TGSQ-L | Square Plinth, 22" x 22" - Laminate | 977 | 70 |
| TGSQ-V | Square Plinth, 22" x 22" - Veneer | 1151 | 70 |
| TGMNT2 | Manhattan Round Double Column | 387 | 22 |
| TGMRT2 | Manhattan Rectangular Double Column | 426 | 22 |
| TGMNT2-VWM | Manhattan Round Double Column with 1 Oval Vertical Wire Manager | 574 | 27 |
| TGMNT2-RVWM | Manhattan Round Double Column with 1 Rectangular Vertical Wire Manager | 574 | 27 |
| TGMNT2-VWM2 | Manhattan Round Double Column with 2 Oval Vertical Wire Managers | 763 | 32 |
| TGMNT2-RVWM2 | Manhattan Round Double Column with 2 Rectangular Vertical Wire Managers | 763 | 32 |

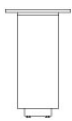

TGRE

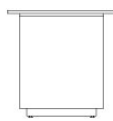

TGSQ

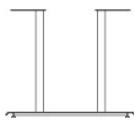

TGMNT2

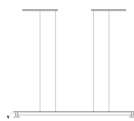

TGMRT2

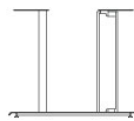

TGMNT2 WITH 1 VERTICAL WIRE MANAGER

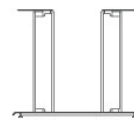

TGMNT2 WITH 2 VERTICAL WIRE MANAGERS

STANDARD FEATURES

- Select from 15 standard laminates or choose any standard Wilsonart, Nevamar, Formica, Arborite and Pionite matte finish laminates at no upcharge. For other laminate please contact the factory for pricing.
- 9 standard veneer and hardwood edge stains. Stain-to-match available at no upcharge.
- Standard with leveling glides.
- Plinth bases are standard with touch latch removable door.

- Plinth bases are standard with kickplate, finished in HOMAPAL 441 Brushed Natural Aluminum.
- Metal bases available in any Spectone color.
- Standard 29" table height.

OPTIONS

- For additional Power & Data modules, please see Table Accessories Price List.
- Cutout for wire pass-through at the bottom of Tailgate bases must be specified if required.



HOW TO ORDER

1. Select Top Size
2. Select Top Finish
3. Select Edge Style & Finish
4. Select Base
5. Select Base Finish

Example: 4896RT - MNT2 -





TAILGATE TABLES

TABLETOP



| SIZE | TABLETOPS | | TOP AND EDGE SPECIFICATIONS | | | | | | TROUGHS | | BASES | | SEATS | LBS |
|------------------|-----------|--------------------|-----------------------------|-------|--------------|-------------------------|--------------------------------------|-------------------------|-------------------|---------------------|--------------------------|-------------|-------|-----------------|
| | Model | Number of Sections | SE PVF 2MM | HF HB | HBV HBVR HBG | HF2 HB2 HKN4 HKNR4 HBG2 | For Veneer Top HF HB HBV HBVR HBG | HF2 HB2 HKN4 HKNR4 HBG2 | Number of Troughs | Length of Trough(s) | Number of Bases Required | TGRE TGMNT2 | TGSQ | Number of Seats |
| <i>Boatshape</i> | | | | | | | | | | | | | | |
| 48 x 96 | TG4896BT | 1 | 2602 | 4333 | 4655 | 4987 | 5458 | 5872 | 1 | 52 | 2 | 2 | 8 | 135 |
| 48 x 120 | TG48120BT | 2 | 3018 | 5419 | 5818 | 6240 | 6419 | 6898 | 1 | 76 | 3 | 2 | 10 | 168 |
| 48 x 144 | TG48144BT | 2 | 4005 | 6808 | 7284 | 7790 | 8428 | 8863 | 2 | 40 | 3 | 3 | 10 | 202 |
| 48 x 168 | TG48168BT | 2 | 5015 | 8077 | 8632 | 9216 | 9514 | 10186 | 2 | 52 | 3 | 3 | 12 | 236 |
| 48 x 192 | TG48192BT | 2 | 5204 | 8958 | 9597 | 10861 | 11201 | 12207 | 2 | 52 | 3 | 3 | 14 | 269 |
| 48 x 216 | TG48216BT | 2 | 6065 | 9900 | 10621 | 12194 | 12583 | 13559 | 2 | 76 | 3 | 3 | 14 | 303 |
| 60 x 120 | TG60120BT | 2 | 3464 | 6463 | 6966 | 7492 | 7718 | 8312 | 1 | 76 | 3 | 2 | 10 | 210 |
| 60 x 144 | TG60144BT | 2 | 4551 | 8056 | 8651 | 9284 | 10079 | 10625 | 2 | 40 | 3 | 3 | 12 | 252 |
| 60 x 168 | TG60168BT | 2 | 5690 | 9518 | 10209 | 10940 | 11310 | 12152 | 2 | 52 | 3 | 3 | 12 | 294 |
| 60 x 192 | TG60192BT | 2 | 6361 | 10955 | 11785 | 12664 | 13107 | 14116 | 2 | 52 | 3 | 3 | 14 | 336 |
| 60 x 216 | TG60216BT | 2 | 7008 | 12175 | 13111 | 14098 | 14596 | 15734 | 2 | 76 | 3 | 3 | 16 | 378 |

Price of top includes troughs and power duplexes. Number of duplexes varies depending on trough size and number of troughs per table. Trough door opens and closes from either side. An open perimeter around each side of the trough door allows the door to be closed while laptops and other items are plugged in.

BASES

| MODEL | BASE SHAPE | LIST PRICE | LBS |
|--------------|---|------------|-----|
| TGRE-L | Rectangle Plinth, 11" x 22" - Laminate | 977 | 60 |
| TGRE-V | Rectangle Plinth, 11" x 22" - Veneer | 1151 | 60 |
| TGSQ-L | Square Plinth, 22" x 22" - Laminate | 977 | 70 |
| TGSQ-V | Square Plinth, 22" x 22" - Veneer | 1151 | 70 |
| TGMNT2 | Manhattan Round Double Column | 387 | 22 |
| TGMRT2 | Manhattan Rectangular Double Column | 426 | 22 |
| TGMNT2-VWM | Manhattan Round Double Column with 1 Oval Vertical Wire Manager | 574 | 27 |
| TGMNT2-RVWM | Manhattan Round Double Column with 1 Rectangular Vertical Wire Manager | 574 | 27 |
| TGMNT2-VWM2 | Manhattan Round Double Column with 2 Oval Vertical Wire Managers | 763 | 32 |
| TGMNT2-RVWM2 | Manhattan Round Double Column with 2 Rectangular Vertical Wire Managers | 763 | 32 |

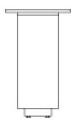

TGRE

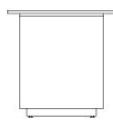

TGSQ

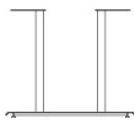

TGMNT2

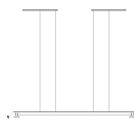

TGMRT2

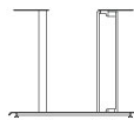

TGMNT2 WITH 1 VERTICAL WIRE MANAGER

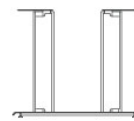

TGMNT2 WITH 2 VERTICAL WIRE MANAGERS

STANDARD FEATURES

- Select from 15 standard laminates or choose any standard Wilsonart, Nevamar, Formica, Arborite and Pionite matte finish laminates at no upcharge. For other laminate please contact the factory for pricing.
- 9 standard veneer and hardwood edge stains. Stain-to-match available at no upcharge.
- Standard with leveling glides.
- Plinth bases are standard with touch latch removable door.

- Plinth bases are standard with kickplate, finished in HOMAPAL 441 Brushed Natural Aluminum.
- Metal bases available in any Spectone color.
- Standard 29" table height.

OPTIONS

- For additional Power & Data modules, please see Table Accessories Price List.
- Cutout for wire pass-through at the bottom of Tailgate bases must be specified if required.



HOW TO ORDER

1. Select Top Size
2. Select Top Finish
3. Select Edge Style & Finish
4. Select Base
5. Select Base Finish

Example: 4896BT - MNT2 -





TAILGATE TABLES

TABLETOP

BACK TO CONTENTS

| SIZE | TABLETOPS | | TOP AND EDGE SPECIFICATIONS | | | | | | TROUGHS | | BASES | | SEATS | LBS |
|---------------------------|------------|--------------------|-----------------------------|-------|--------------|-------------------------|--------------------------------------|-------------------------|-------------------|---------------------|--------------------------|-------------|-------|-----------------|
| | Model | Number of Sections | SE PVF 2MM | HF HB | HBV HBVR HBG | HF2 HB2 HKN4 HKNR4 HBG2 | For Veneer Top HF HB HBV HBVR HBG | HF2 HB2 HKN4 HKNR4 HBG2 | Number of Troughs | Length of Trough(s) | Number of Bases Required | TGRE TGMNT2 | TGSQ | Number of Seats |
| <i>Boatshape Arc Ends</i> | | | | | | | | | | | | | | |
| 48 x 96 | TG4896BTA | 1 | 2778 | 4884 | 5208 | 5542 | 6010 | 6424 | 1 | 52 | 2 | 2 | 8 | 135 |
| 48 x 120 | TG48120BTA | 2 | 3193 | 5973 | 6373 | 6795 | 6974 | 7449 | 1 | 76 | 3 | 2 | 10 | 168 |
| 48 x 144 | TG48144BTA | 2 | 4181 | 7359 | 7839 | 8345 | 8979 | 9417 | 2 | 40 | 3 | 3 | 10 | 202 |
| 48 x 168 | TG48168BTA | 2 | 5192 | 8632 | 9187 | 9771 | 10067 | 10742 | 2 | 52 | 3 | 3 | 12 | 236 |
| 48 x 192 | TG48192BTA | 2 | 5492 | 9621 | 10323 | 11716 | 12091 | 13195 | 2 | 52 | 3 | 3 | 14 | 269 |
| 48 x 216 | TG48216BTA | 2 | 6423 | 10646 | 11438 | 13166 | 13596 | 14669 | 2 | 76 | 3 | 3 | 14 | 303 |
| 60 x 120 | TG60120BTA | 2 | 3685 | 7158 | 7657 | 8184 | 8408 | 9003 | 1 | 76 | 3 | 2 | 10 | 210 |
| 60 x 144 | TG60144BTA | 2 | 4770 | 8745 | 9344 | 9975 | 10771 | 11314 | 2 | 40 | 3 | 3 | 12 | 252 |
| 60 x 168 | TG60168BTA | 2 | 5909 | 10209 | 10901 | 11630 | 12003 | 12847 | 2 | 52 | 3 | 3 | 12 | 294 |
| 60 x 192 | TG60192BTA | 2 | 6626 | 11785 | 12616 | 13489 | 13938 | 14951 | 2 | 52 | 3 | 3 | 14 | 336 |
| 60 x 216 | TG60216BTA | 2 | 7308 | 13111 | 14045 | 15028 | 15530 | 16669 | 2 | 76 | 3 | 3 | 16 | 378 |

Price of top includes troughs and power duplexes. Number of duplexes varies depending on trough size and number of troughs per table. Trough door opens and closes from either side. An open perimeter around each side of the trough door allows the door to be closed while laptops and other items are plugged in.

BASES

| MODEL | BASE SHAPE | LIST PRICE | LBS |
|--------------|---|------------|-----|
| TGRE-L | Rectangle Plinth, 11" x 22" - Laminate | 977 | 60 |
| TGRE-V | Rectangle Plinth, 11" x 22" - Veneer | 1151 | 60 |
| TGSQ-L | Square Plinth, 22" x 22" - Laminate | 977 | 70 |
| TGSQ-V | Square Plinth, 22" x 22" - Veneer | 1151 | 70 |
| TGMNT2 | Manhattan Round Double Column | 387 | 22 |
| TGMRT2 | Manhattan Rectangular Double Column | 426 | 22 |
| TGMNT2-VWM | Manhattan Round Double Column with 1 Oval Vertical Wire Manager | 574 | 27 |
| TGMNT2-RVWM | Manhattan Round Double Column with 1 Rectangular Vertical Wire Manager | 574 | 27 |
| TGMNT2-VWM2 | Manhattan Round Double Column with 2 Oval Vertical Wire Managers | 763 | 32 |
| TGMNT2-RVWM2 | Manhattan Round Double Column with 2 Rectangular Vertical Wire Managers | 763 | 32 |



TGRE

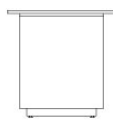

TGSQ

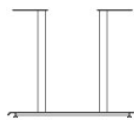

TGMNT2

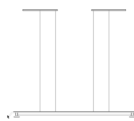

TGMRT2

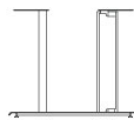

TGMNT2 WITH 1 VERTICAL WIRE MANAGER

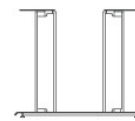

TGMNT2 WITH 2 VERTICAL WIRE MANAGERS

STANDARD FEATURES

- Select from 15 standard laminates or choose any standard Wilsonart, Nevamar, Formica, Arborite and Pionite matte finish laminates at no upcharge. For other laminate please contact the factory for pricing.
- 9 standard veneer and hardwood edge stains. Stain-to-match available at no upcharge.
- Standard with leveling glides.
- Plinth bases are standard with touch latch removable door.

- Plinth bases are standard with kickplate, finished in HOMAPAL 441 Brushed Natural Aluminum.
- Metal bases available in any Spectone color.
- Standard 29" table height.

OPTIONS

- For additional Power & Data modules, please see Table Accessories Price List.
- Cutout for wire pass-through at the bottom of Tailgate bases must be specified if required.



HOW TO ORDER

1. Select Top Size
2. Select Top Finish
3. Select Edge Style & Finish
4. Select Base
5. Select Base Finish

Example: 4896BTA - MNT2 -





BACK TO CONTENTS

TAILGATE TABLES

TABLETOP



| SIZE | TABLETOPS | | TOP AND EDGE SPECIFICATIONS | | | | | | TROUGHS | | BASES | | SEATS | LBS |
|----------------|-----------|--------------------|-----------------------------|-------|--------------|-------------------------|-----------------------------------|-------------------------|-------------------|---------------------|--------------------------|-------------|-------|-----------------|
| | Model | Number of Sections | SE PVF 2MM | HF HB | HBV HBVR HBG | HF2 HB2 HKN4 HKNR4 HBG2 | For Veneer Top HF HB HBV HBVR HBG | HF2 HB2 HKN4 HKNR4 HBG2 | Number of Troughs | Length of Trough(s) | Number of Bases Required | TGRE TGMNT2 | TGSQ | Number of Seats |
| <i>Ellipse</i> | | | | | | | | | | | | | | |
| 48 x 96 | TG4896EL | 1 | 2890 | 4966 | 5353 | 5754 | 6315 | 6811 | 1 | 52 | 2 | 2 | 8 | 135 |
| 48 x 120 | TG48120EL | 2 | 3375 | 6256 | 6737 | 7241 | 7458 | 8027 | 1 | 76 | 3 | 2 | 10 | 168 |
| 48 x 144 | TG48144EL | 2 | 4441 | 7805 | 8377 | 8986 | 9749 | 10273 | 2 | 40 | 3 | 3 | 10 | 202 |
| 48 x 168 | TG48168EL | 2 | 5555 | 9227 | 9894 | 10594 | 10924 | 11760 | 2 | 52 | 3 | 3 | 12 | 236 |
| 48 x 192 | TG48192EL | 2 | 5806 | 10351 | 11122 | 12653 | 13068 | 14283 | 2 | 52 | 3 | 3 | 14 | 269 |
| 48 x 216 | TG48216EL | 2 | 6819 | 11463 | 12334 | 14236 | 14707 | 15889 | 2 | 76 | 3 | 3 | 14 | 303 |
| 60 x 120 | TG60120EL | 2 | 4053 | 8047 | 8620 | 9226 | 9484 | 10168 | 1 | 76 | 3 | 2 | 10 | 210 |
| 60 x 144 | TG60144EL | 2 | 5212 | 9783 | 10471 | 11200 | 12112 | 12739 | 2 | 40 | 3 | 3 | 12 | 252 |
| 60 x 168 | TG60168EL | 2 | 6446 | 11393 | 12188 | 13027 | 13456 | 14423 | 2 | 52 | 3 | 3 | 12 | 294 |
| 60 x 192 | TG60192EL | 2 | 7273 | 13203 | 14159 | 15165 | 15680 | 16844 | 2 | 52 | 3 | 3 | 14 | 336 |
| 60 x 216 | TG60216EL | 2 | 8034 | 14707 | 15782 | 16910 | 17491 | 18798 | 2 | 76 | 3 | 3 | 16 | 378 |

Price of top includes troughs and power duplexes. Number of duplexes varies depending on trough size and number of troughs per table. Trough door opens and closes from either side. An open perimeter around each side of the trough door allows the door to be closed while laptops and other items are plugged in.

BASES

| MODEL | BASE SHAPE | LIST PRICE | LBS |
|--------------|---|------------|-----|
| TGRE-L | Rectangle Plinth, 11" x 22" - Laminate | 977 | 60 |
| TGRE-V | Rectangle Plinth, 11" x 22" - Veneer | 1151 | 60 |
| TGSQ-L | Square Plinth, 22" x 22" - Laminate | 977 | 70 |
| TGSQ-V | Square Plinth, 22" x 22" - Veneer | 1151 | 70 |
| TGMNT2 | Manhattan Round Double Column | 387 | 22 |
| TGMRT2 | Manhattan Rectangular Double Column | 426 | 22 |
| TGMNT2-VWM | Manhattan Round Double Column with 1 Oval Vertical Wire Manager | 574 | 27 |
| TGMNT2-RVWM | Manhattan Round Double Column with 1 Rectangular Vertical Wire Manager | 574 | 27 |
| TGMNT2-VWM2 | Manhattan Round Double Column with 2 Oval Vertical Wire Managers | 763 | 32 |
| TGMNT2-RVWM2 | Manhattan Round Double Column with 2 Rectangular Vertical Wire Managers | 763 | 32 |

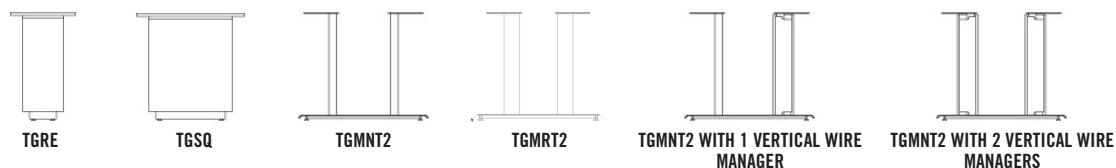

STANDARD FEATURES

- Select from 15 standard laminates or choose any standard Wilsonart, Nevamar, Formica, Arborite and Pionite matte finish laminates at no upcharge. For other laminate please contact the factory for pricing.
- 9 standard veneer and hardwood edge stains. Stain-to-match available at no upcharge.
- Standard with leveling glides.
- Plinth bases are standard with touch latch removable door.

- Plinth bases are standard with kickplate, finished in HOMAPAL 441 Brushed Natural Aluminum.
- Metal bases available in any Spectone color.
- Standard 29" table height.

OPTIONS

- For additional Power & Data modules, please see Table Accessories Price List.
- Cutout for wire pass-through at the bottom of Tailgate bases must be specified if required.

HOW TO ORDER

1. Select Top Size
2. Select Top Finish
3. Select Edge Style & Finish
4. Select Base
5. Select Base Finish

Example: 4896EL - MNT2 -





BACK TO CONTENTS

TAILGATE TABLES

TABLETOP

| SIZE | TABLETOPS | | TOP AND EDGE SPECIFICATIONS | | | | | | TROUGHS | | BASES | | SEATS | LBS |
|-------------------------|-----------|--------------------|-----------------------------|-------|--------------|-------------------------|-----------------------------------|-------------------------|-------------------|---------------------|--------------------------|-------------|-------|-----------------|
| | Model | Number of Sections | SE PVF 2MM | HF HB | HBV HBVR HBG | HF2 HB2 HKN4 HKNR4 HBG2 | For Veneer Top HF HB HBV HBVR HBG | HF2 HB2 HKN4 HKNR4 HBG2 | Number of Troughs | Length of Trough(s) | Number of Bases Required | TGRE TGMNT2 | TGSQ | Number of Seats |
| <i>Video Conference</i> | | | | | | | | | | | | | | |
| 48 x 96 | TG4896VC | 1 | 2602 | 4333 | 4655 | 4987 | 5458 | 5872 | 1 | 52 | 2 | 2 | 8 | 135 |
| 48 x 120 | TG48120VC | 2 | 3018 | 5419 | 5818 | 6240 | 6419 | 6898 | 1 | 76 | 3 | 2 | 10 | 168 |
| 48 x 144 | TG48144VC | 2 | 4005 | 6808 | 7284 | 7790 | 8428 | 8863 | 2 | 40 | 3 | 3 | 10 | 202 |
| 48 x 168 | TG48168VC | 2 | 5015 | 8077 | 8632 | 9216 | 9493 | 10186 | 2 | 52 | 3 | 3 | 12 | 236 |
| 48 x 192 | TG48192VC | 2 | 5204 | 8958 | 9597 | 10861 | 11201 | 12207 | 2 | 52 | 3 | 3 | 14 | 269 |
| 48 x 216 | TG48216VC | 2 | 6065 | 9900 | 10621 | 12194 | 12583 | 13559 | 2 | 76 | 3 | 3 | 14 | 303 |
| 60 x 120 | TG60120VC | 2 | 3464 | 6463 | 6966 | 7492 | 7718 | 8312 | 1 | 76 | 3 | 2 | 10 | 210 |
| 60 x 144 | TG60144VC | 2 | 4551 | 8056 | 8651 | 9284 | 10079 | 10625 | 2 | 40 | 3 | 3 | 12 | 252 |
| 60 x 168 | TG60168VC | 2 | 5690 | 9518 | 10209 | 10940 | 11310 | 12152 | 2 | 52 | 3 | 3 | 12 | 294 |
| 60 x 192 | TG60192VC | 2 | 6361 | 10955 | 11785 | 12664 | 13107 | 14116 | 2 | 52 | 3 | 3 | 14 | 336 |
| 60 x 216 | TG60216VC | 2 | 7008 | 12175 | 13111 | 14098 | 14596 | 15734 | 2 | 76 | 3 | 3 | 16 | 378 |

Price of top includes troughs and power duplexes. Number of duplexes varies depending on trough size and number of troughs per table. Trough door opens and closes from either side. An open perimeter around each side of the trough door allows the door to be closed while laptops and other items are plugged in.

BASES

| MODEL | BASE SHAPE | LIST PRICE | LBS |
|--------------|---|------------|-----|
| TGRE-L | Rectangle Plinth, 11" x 22" - Laminate | 977 | 60 |
| TGRE-V | Rectangle Plinth, 11" x 22" - Veneer | 1151 | 60 |
| TGSQ-L | Square Plinth, 22" x 22" - Laminate | 977 | 70 |
| TGSQ-V | Square Plinth, 22" x 22" - Veneer | 1151 | 70 |
| TGMNT2 | Manhattan Round Double Column | 387 | 22 |
| TGMRT2 | Manhattan Rectangular Double Column | 426 | 22 |
| TGMNT2-VWM | Manhattan Round Double Column with 1 Oval Vertical Wire Manager | 574 | 27 |
| TGMNT2-RVWM | Manhattan Round Double Column with 1 Rectangular Vertical Wire Manager | 574 | 27 |
| TGMNT2-VWM2 | Manhattan Round Double Column with 2 Oval Vertical Wire Managers | 763 | 32 |
| TGMNT2-RVWM2 | Manhattan Round Double Column with 2 Rectangular Vertical Wire Managers | 763 | 32 |

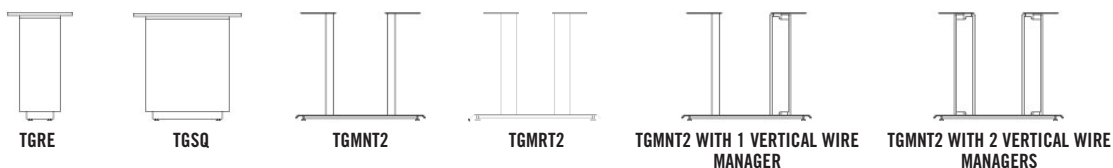

STANDARD FEATURES

- Select from 15 standard laminates or choose any standard Wilsonart, Nevamar, Formica, Arborite and Pionite matte finish laminates at no upcharge. For other laminate please contact the factory for pricing.
- 9 standard veneer and hardwood edge stains. Stain-to-match available at no upcharge.
- Standard with leveling glides.
- Plinth bases are standard with touch latch removable door.

- Plinth bases are standard with kickplate, finished in HOMAPAL 441 Brushed Natural Aluminum.
- Metal bases available in any Spectone color.
- Standard 29" table height.

OPTIONS

- For additional Power & Data modules, please see Table Accessories Price List.
- Cutout for wire pass-through at the bottom of Tailgate bases must be specified if required.

HOW TO ORDER

1. Select Top Size
2. Select Top Finish
3. Select Edge Style & Finish
4. Select Base
5. Select Base Finish

Example: 4896VC - MNT2 -

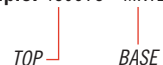

TAILGATE TABLES

TABLETOP

| SIZE | TABLETOPS | | TOP AND EDGE SPECIFICATIONS | | | | | | TROUGHS | | BASES | | SEATS | LBS |
|----------------------------------|------------|--------------------|-----------------------------|-------|--------------|-------------------------|-----------------------------------|-------------------------|-------------------|---------------------|--------------------------|-------------|-------|-----------------|
| | Model | Number of Sections | SE PVF 2MM | HF HB | HBV HBVR HBG | HF2 HB2 HKN4 HKNR4 HBG2 | For Veneer Top HF HB HBV HBVR HBG | HF2 HB2 HKN4 HKNR4 HBG2 | Number of Troughs | Length of Trough(s) | Number of Bases Required | TGRE TGMNT2 | TGSQ | Number of Seats |
| <i>Video Conference Arc Ends</i> | | | | | | | | | | | | | | |
| 48 x 96 | TG4896VCA | 1 | 2778 | 4884 | 5208 | 5542 | 6010 | 6424 | 1 | 52 | 2 | 2 | 8 | 135 |
| 48 x 120 | TG48120VCA | 2 | 3193 | 5973 | 6373 | 6795 | 6974 | 7449 | 1 | 76 | 3 | 2 | 10 | 168 |
| 48 x 144 | TG48144VCA | 2 | 4181 | 7359 | 7839 | 8345 | 8979 | 9417 | 2 | 40 | 3 | 3 | 10 | 202 |
| 48 x 168 | TG48168VCA | 2 | 5192 | 8632 | 9187 | 9771 | 10067 | 10742 | 2 | 52 | 3 | 3 | 12 | 236 |
| 48 x 192 | TG48192VCA | 2 | 5492 | 9621 | 10323 | 11716 | 12091 | 13195 | 2 | 52 | 3 | 3 | 14 | 269 |
| 48 x 216 | TG48216VCA | 2 | 6423 | 10646 | 11438 | 13166 | 13596 | 14669 | 2 | 76 | 3 | 3 | 14 | 303 |
| 60 x 120 | TG60120VCA | 2 | 3685 | 7158 | 7657 | 8184 | 8408 | 9003 | 1 | 76 | 3 | 2 | 10 | 210 |
| 60 x 144 | TG60144VCA | 2 | 4770 | 8745 | 9344 | 9975 | 10771 | 11314 | 2 | 40 | 3 | 3 | 12 | 252 |
| 60 x 168 | TG60168VCA | 2 | 5909 | 10209 | 10901 | 11630 | 12003 | 12847 | 2 | 52 | 3 | 3 | 12 | 294 |
| 60 x 192 | TG60192VCA | 2 | 6626 | 11785 | 12616 | 13489 | 13938 | 14951 | 2 | 52 | 3 | 3 | 14 | 336 |
| 60 x 216 | TG60216VCA | 2 | 7308 | 13111 | 14045 | 15028 | 15530 | 16669 | 2 | 76 | 3 | 3 | 16 | 378 |

Price of top includes troughs and power duplexes. Number of duplexes varies depending on trough size and number of troughs per table. Trough door opens and closes from either side. An open perimeter around each side of the trough door allows the door to be closed while laptops and other items are plugged in.

BASES

| MODEL | BASE SHAPE | LIST PRICE | LBS |
|--------------|---|------------|-----|
| TGRE-L | Rectangle Plinth, 11" x 22" - Laminate | 977 | 60 |
| TGRE-V | Rectangle Plinth, 11" x 22" - Veneer | 1151 | 60 |
| TGSQ-L | Square Plinth, 22" x 22" - Laminate | 977 | 70 |
| TGSQ-V | Square Plinth, 22" x 22" - Veneer | 1151 | 70 |
| TGMNT2 | Manhattan Round Double Column | 387 | 22 |
| TGMRT2 | Manhattan Rectangular Double Column | 426 | 22 |
| TGMNT2-VWM | Manhattan Round Double Column with 1 Oval Vertical Wire Manager | 574 | 27 |
| TGMNT2-RVWM | Manhattan Round Double Column with 1 Rectangular Vertical Wire Manager | 574 | 27 |
| TGMNT2-VWM2 | Manhattan Round Double Column with 2 Oval Vertical Wire Managers | 763 | 32 |
| TGMNT2-RVWM2 | Manhattan Round Double Column with 2 Rectangular Vertical Wire Managers | 763 | 32 |



TGRE

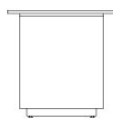

TGSQ

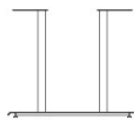

TGMNT2

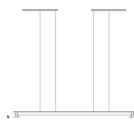

TGMRT2

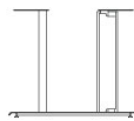

TGMNT2 WITH 1 VERTICAL WIRE MANAGER

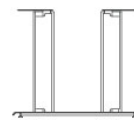

TGMNT2 WITH 2 VERTICAL WIRE MANAGERS

STANDARD FEATURES

- Select from 15 standard laminates or choose any standard Wilsonart, Nevamar, Formica, Arborite and Pionite matte finish laminates at no upcharge. For other laminate please contact the factory for pricing.
- 9 standard veneer and hardwood edge stains. Stain-to-match available at no upcharge.
- Standard with leveling glides.
- Plinth bases are standard with touch latch removable door.

- Plinth bases are standard with kickplate, finished in HOMAPAL 441 Brushed Natural Aluminum.
- Metal bases available in any Spectone color.
- Standard 29" table height.

OPTIONS

- For additional Power & Data modules, please see Table Accessories Price List.
- Cutout for wire pass-through at the bottom of Tailgate bases must be specified if required.



HOW TO ORDER

1. Select Top Size
2. Select Top Finish
3. Select Edge Style & Finish
4. Select Base
5. Select Base Finish

Example: 4896VCA - MNT2 -





TAILGATE TABLES POWER AND VOICE/DATA ACCESSORIES

Power and Communication Trough is included in price.

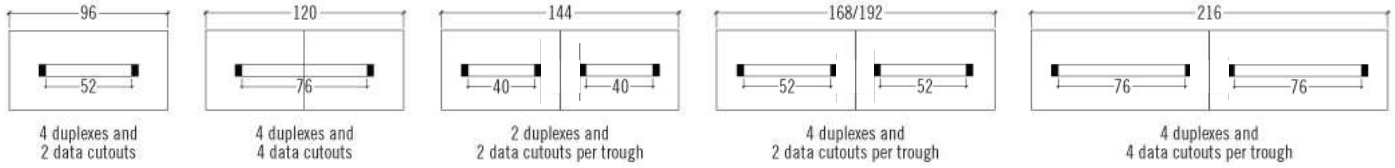

Each trough is standard with power duplexes (labelled P) with a 9 ft. cord. Cutouts for data and communication (labelled D) are also included, however, data ports must be specified separately and can be configured to meet specific requirements. Specify blank plates when data and communication is not required at no upcharge.

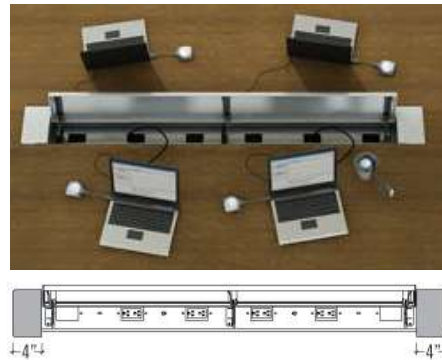
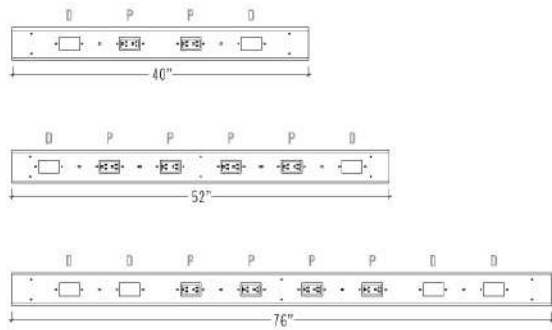

Units in data plates must equal 3. Plates can be made up of items that equal 1 unit each for a total of 3 units or a combination of items that total 3 units.

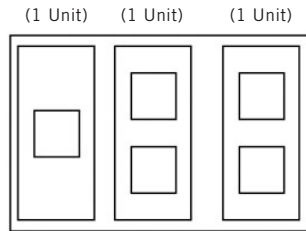

OPTION 11 - \$138 List
15 Pin VGA
(1 Unit)
Front: 15 Pin Female
Back: 15 Pin Female



OPTION 14 - No Charge
Blank
(1 Unit)



OPTION 22 - \$243 List
USB 2.0 Performance
(1 Unit)
Front: Type A & A (F/F)
Back: Type A & A (F/F)



OPTION 23 - \$201 List
HDMI-A/V Connector
(1 Unit)
Front: Female
Back: Female



OPTION 28 - \$79 List
RJ 45 (cat. 6) X 2
(1 Unit)



OPTION 29 - \$43 List
RJ 45 (cat. 6) X 1
(1 Unit)



TAILGATE TABLES VOICE/DATA ACCESSORIES

Examples of 1 Data Plate

PLATE CONFIGURATION OPTIONS FOR DATA & PHONE

6X RJ 45 (CAT. 6)



CONFIGURATION A

Consists of the following:

- 3x **OPTION 28** = \$ 79 LIST
- TOTAL LIST** = \$237 LIST

PLATE CONFIGURATION OPTIONS FOR AUDIO/VIDEO

1X HDMI A/V CONNECTOR, 15 PIN V99 AND BLANK

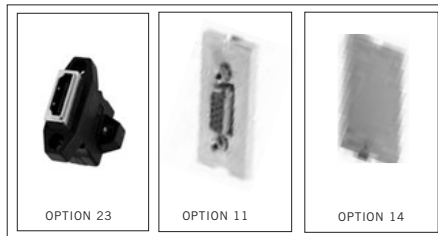

CONFIGURATION D

Consists of the following:

- 1x **OPTION 23** = \$201 LIST
- 1x **OPTION 11** = \$138 LIST
- 1x **OPTION 14** = NO CHARGE
- TOTAL LIST** = \$339 LIST





TAILOR Lounge Collection - FREESTANDING TABLES

Standard Features

- Tables in laminate or veneer
- Select laminate tops from 15 standard laminates or choose any standard Wilsonart, Nevamar, Formica, Arborite and Pionite matte finish laminates at no upcharge.
- 9 standard veneers. Stain-to-match available at no upcharge.
- Tables available with Self Edge (SE) only
- Steel table legs available in any Spectone color
- Tops utilize NU Green earth friendly core
- Glides
- Ships assembled
- 18" height

Options

- To add Cove Mini, clamp mounted with 1 power, 2 USB (charging only), and a 108" long cord to Tailor freestanding tables, add \$344 List. Cove will be located on the flat front face of the closed tables as standard. It is not recommended to specify power on open tables. Specify separately at time of order.



- Black **COVSMC1P1U-B**
- Silver Pearl **COVSMC1P1U-S**
- Gloss White **COVSMC1P1U-W**



Freestanding Lounge Tables

| Model | Laminate SE | Veneer SE | Weight | Cu.Ft. |
|---|-------------|-----------|--------|--------|
| 91ETC - 24 x 24 SQ <i>End Table Closed - 24 x 24</i> | 969 | 1357 | 39 | 11 |
| 91ETO - 24 x 24 SQ <i>End Table Open - 24 x 24</i> | 991 | 1387 | 38 | 11 |
| 91REC - 24 x 48 RE <i>Coffee Table Closed - 24 x 48</i> | 1109 | 1552 | 67 | 20 |
| 91REOS - 24 x 48 RE <i>Coffee Table Open, One Side - 24 x 48</i> | 1328 | 1860 | 67 | 20 |
| 91REOB - 24 x 48 RE <i>Coffee Table Open, Both Sides - 24 x 48</i> | 1360 | 1904 | 71 | 20 |



91ETC
39 lbs



91ETO
38 lbs



91REC
67 lbs



91REOS
67 lbs



91REOB
71 lbs



TAILOR Lounge Collection - BOOTH

TABLES



| MODEL | BASES | | | TOP SPECIFICATIONS | OPTIONS | LBS |
|-------------------|------------|---------|------|-------------------------------|---------|-----|
| | Code | Size | Qty. | | | |
| | | | | For Laminate Top SE 2MM | | |
| <i>Rectangle</i> | | | | | | |
| <i>29" high</i> | | | | | | |
| 30 X 46 RE | TBT | 20 X 36 | 1 | 1340 | | 123 |
| 36 X 46 RE | TBT | 26 X 36 | 1 | 1611 | | 153 |
| 42 X 46 RE | TBT | 32 X 36 | 1 | 2032 | | 183 |
| 30 X 69 RE | TBT | 20 X 27 | 2 | 2311 | | 185 |
| 36 X 69 RE | TBT | 26 X 27 | 2 | 2587 | | 230 |
| 42 X 69 RE | TBT | 32 X 27 | 2 | 3099 | | 276 |



30X46RE TBT

30X69RE TBT

STANDARD FEATURES

- Select from 15 standard laminates or choose any standard Wilsonart, Nevamar, Formica, Arborite and Pionite matte finish laminates at no upcharge. For other laminate please contact the factory for pricing.
- Standard with leveling glides.
- Bases available in any Spectone color.
- Standard 29" table height.
- Ships Knocked Down.

HOW TO ORDER

1. Select Model
2. Select Base
3. Select Edge Style
4. Select Options
5. Select Top Finish
6. Select Edge Finish
7. Select Base Finish

Example: 3046RE - TBT - 2MM



TRUMPET & FLAT BASE TABLES



PRODUCT CODE

2424 SQ TR 18

Top Size
Width x Length

Top Shape
D : Round
SQ : Square
RE : Rectangle

Series
DISC : Disc
TR : Trumpet
SMB : Square Metal
RMB : Rectangle Metal

Height
18 : Occasional and Lounge Table Height
29 : General Purpose Table Height
42 : Bar Table Height

FINISHES

LAMINATE



Select from 15 standard laminates or choose any standard Wilsonart, Nevamar, Formica, Arborite and Pionite matte finish laminates at no upcharge

VENEER



Select from one of our 9 standard wood stains or stain-to-match at no upcharge

BASE



Select from one of our 76 standard Spectone colors

EDGE



See Spectone Card or specfurniture.com/materials/finishes for a complete list of finish options and colors.



TRUMPET & FLAT BASE TABLES

HOW TO ORDER

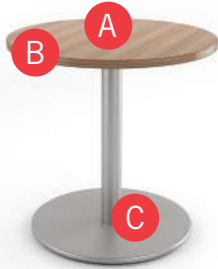

Specify Top Size (Width x Length) and Shape

- A** Specify Top Type and Finish
For Laminate Top: Manufacturer, Laminate Name, Laminate Code
For Veneer Top: Wood Stain
- B** Specify Edge Type, (for hardwood: Style), and Finish
PVC/2mm/Self Edge/Exposed Baltic Birch Plywood/Hardwood
- C** Specify Base Style and Finish

Optional: Power and Data Modules, Custom Solutions

| Top Size and Shape | Top Type and Finish | Edge Type, (Style), and Finish | Base Style and Finish |
|--------------------|---------------------------------|--|-----------------------|
| 36D, Round | Laminate, Arborite, Brown Sugar | Hardwood, HF, Custom Brown Sugar Stain | DISC, Silver |



EDGE PROFILES

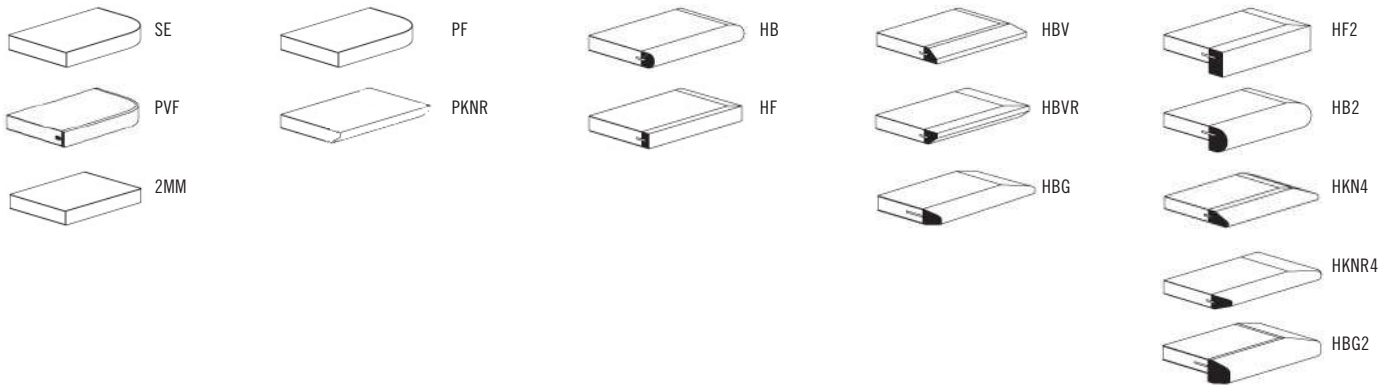



TRUMPET & FLAT BASE TABLES - TRUMPET BASE



| MODEL | BASES | | TOP SPECIFICATIONS | | | | | | OPTIONS | LBS |
|-----------------|-------|------|--------------------|--|--------------------|----------------------------|------------------------|----------------------------|---------|-----|
| | Code | Qty. | For Laminate Top | | | For Veneer Top | | | | |
| | | | SE PVF 2MM | HF HB PKNR ¹ PF ¹ | HBV HBVR HBG | HF2 HB2 HKN4 HBG2 | HF HB HBV HBG | HF2 HB2 HKN4 HBG2 | | |
| <i>18" high</i> | | | | | | | | | | |
| <i>Round</i> | | | | | | | | | | |
| 24D | TR18 | 1 | 654 | 1014 | 1051 | 1160 | 1219 | 1331 | | 61 |
| 30D | TR18 | 1 | 758 | 1113 | 1160 | 1378 | 1323 | 1487 | | 71 |
| 36D | TR18 | 1 | 857 | 1370 | 1461 | 1639 | 1693 | 1922 | | 82 |
| 42D | TR18 | 1 | 1142 | 1718 | 1842 | 2107 | 2133 | 2446 | | 96 |
| <i>Square</i> | | | | | | | | | | |
| 18 X 18SQ | TR18 | 1 | 674 | 880 | 917 | 985 | 1035 | 1202 | | 54 |
| 24 X 24SQ | TR18 | 1 | 685 | 880 | 917 | 985 | 1035 | 1202 | | 61 |
| 30 X 30SQ | TR18 | 1 | 792 | 934 | 985 | 1165 | 1099 | 1331 | | 71 |
| 36 X 36SQ | TR18 | 1 | 875 | 1098 | 1160 | 1370 | 1378 | 1578 | | 82 |
| <i>29" high</i> | | | | | | | | | | |
| <i>Round</i> | | | | | | | | | | |
| 24D | TR | 1 | 654 | 1014 | 1051 | 1160 | 1219 | 1331 | | 61 |
| 30D | TR | 1 | 758 | 1113 | 1160 | 1378 | 1323 | 1487 | | 71 |
| 36D | TR | 1 | 857 | 1370 | 1461 | 1639 | 1693 | 1922 | | 82 |
| 42D | TR | 1 | 1142 | 1718 | 1842 | 2107 | 2133 | 2446 | | 96 |
| 48D | TR | 1 | 1165 | 1938 | 2073 | 2205 | 2679 | 3081 | | 112 |
| <i>Square</i> | | | | | | | | | | |
| 24 X 24SQ | TR | 1 | 685 | 880 | 917 | 985 | 1035 | 1202 | | 61 |
| 30 X 30SQ | TR | 1 | 792 | 934 | 985 | 1165 | 1099 | 1331 | | 71 |
| 36 X 36SQ | TR | 1 | 875 | 1098 | 1160 | 1370 | 1378 | 1578 | | 82 |

¹ Exposed Baltic Birch plywood edge (PKNR, PF) can only be specified on square tops up to 47-1/2" x 95-1/2". Clear finish only.



STANDARD FEATURES

- Select from 15 standard laminates or choose any standard Wilsonart, Nevamar, Formica, Arborite and Pionite matte finish laminates at no upcharge. For other laminate please contact the factory for pricing.
- 9 standard veneer and hardwood edge stains. Stain-to-match available at no upcharge.
- Bases available in any Spectone color.
- Standard 18" or 29" table height, please specify.
- All bases are standard with floor leveling glides.

OPTIONS

- Custom heights available.
- For applicable Power & Data modules, please see Table Accessories Price List.

HOW TO ORDER

1. Select Model
2. Select Base
3. Select Edge Style
4. Select Top Finish
5. Select Edge Finish
6. Select Base Finish

Example: 24D - TR18 - PVF





TRUMPET & FLAT BASE TABLES - DISC BASE



| MODEL | BASES | | TOP SPECIFICATIONS | | | | | | OPTIONS | LBS |
|-----------------|--------|------|--------------------|--|--------------------|-------------------------------------|--------------------------------|-------------------------------------|---------|-----|
| | Code | Qty. | For Laminate Top | | | For Veneer Top | | | | |
| | | | SE PVF 2MM | HF HB PKNR ¹ PF ¹ | HBV HBVR HBG | HF2 HB2 HKN4 HKNR4 HBG2 | HF HB HBV HBVR HBG | HF2 HB2 HKN4 HKNR4 HBG2 | | |
| <i>18" high</i> | | | | | | | | | | |
| <i>Round</i> | | | | | | | | | | |
| 24D | DISC18 | 1 | 968 | 1328 | 1365 | 1474 | 1533 | 1645 | | 71 |
| 30D | DISC18 | 1 | 1072 | 1427 | 1474 | 1692 | 1637 | 1801 | | 81 |
| 36D | DISC18 | 1 | 1171 | 1684 | 1775 | 1953 | 2007 | 2236 | | 92 |
| 42D | DISC18 | 1 | 1456 | 2032 | 2156 | 2421 | 2447 | 2760 | | 116 |
| <i>Square</i> | | | | | | | | | | |
| 18 X 18SQ | DISC18 | 1 | 988 | 1194 | 1231 | 1299 | 1349 | 1516 | | 54 |
| 24 X 24SQ | DISC18 | 1 | 999 | 1194 | 1231 | 1299 | 1349 | 1516 | | 61 |
| 30 X 30SQ | DISC18 | 1 | 1106 | 1248 | 1299 | 1479 | 1413 | 1645 | | 91 |
| 36 X 36SQ | DISC18 | 1 | 1189 | 1412 | 1474 | 1684 | 1692 | 1892 | | 102 |
| <i>29" high</i> | | | | | | | | | | |
| <i>Round</i> | | | | | | | | | | |
| 24D | DISC | 1 | 968 | 1328 | 1365 | 1474 | 1533 | 1645 | | 71 |
| 30D | DISC | 1 | 1072 | 1427 | 1474 | 1692 | 1637 | 1801 | | 81 |
| 36D | DISC | 1 | 1171 | 1684 | 1775 | 1953 | 2007 | 2236 | | 92 |
| 42D | DISC | 1 | 1456 | 2032 | 2156 | 2421 | 2447 | 2760 | | 116 |
| 48D | DISC | 1 | 1479 | 2252 | 2387 | 2519 | 2993 | 3395 | | 132 |
| <i>Square</i> | | | | | | | | | | |
| 24 X 24SQ | DISC | 1 | 999 | 1194 | 1231 | 1299 | 1349 | 1516 | | 71 |
| 30 X 30SQ | DISC | 1 | 1106 | 1248 | 1299 | 1479 | 1413 | 1645 | | 91 |
| 36 X 36SQ | DISC | 1 | 1189 | 1412 | 1474 | 1684 | 1692 | 1892 | | 102 |

¹ Exposed Baltic Birch plywood edge (PKNR, PF) can only be specified on square tops up to 47-1/2" x 95-1/2". Clear finish only.



STANDARD FEATURES

- Select from 15 standard laminates or choose any standard Wilsonart, Nevamar, Formica, Arborite and Pionite matte finish laminates at no upcharge. For other laminate please contact the factory for pricing.
- 9 standard veneer and hardwood edge stains. Stain-to-match available at no upcharge.
- Bases available in any Spectone color.
- Standard 18" or 29" table height, please specify.
- All bases are standard with floor leveling glides.

OPTIONS

- Custom heights available.
- For applicable Power & Data modules, please see Table Accessories Price List.

HOW TO ORDER

1. Select Model
2. Select Base
3. Select Edge Style
4. Select Top Finish
5. Select Edge Finish
6. Select Base Finish

Example: 24D - DISC18 - PVF





TRUMPET & FLAT BASE TABLES - SQUARE METAL BASE



| MODEL | BASES | | | TOP SPECIFICATIONS | | | | | | OPTIONS | LBS |
|------------------|-------|------|-----------|--------------------|--|--------------------|-------------------------------------|--------------------------------|-------------------------------------|---------|-----|
| | Code | Qty. | Base Size | For Laminate Top | | | For Veneer Top | | | | |
| | | | | SE PVF 2MM | HF HB PKNR ¹ PF ¹ | HBV HBVR HBG | HF2 HB2 HKN4 HKNR4 HBG2 | HF HB HBV HBVR HBG | HF2 HB2 HKN4 HKNR4 HBG2 | | |
| <i>Square</i> | | | | | | | | | | | |
| <i>18" high</i> | | | | | | | | | | | |
| 24 X 24SQ | SMB18 | 1 | 18X18 | 867 | 1062 | 1099 | 1167 | 1217 | 1384 | | 58 |
| 30 X 30SQ | SMB18 | 1 | 24X24 | 1144 | 1286 | 1337 | 1517 | 1451 | 1683 | | 94 |
| 36 X 36SQ | SMB18 | 1 | 30X30 | 1444 | 1667 | 1729 | 1939 | 1947 | 2147 | | 138 |
| <i>29" high</i> | | | | | | | | | | | |
| 24 X 24SQ | SMB29 | 1 | 18X18 | 867 | 1062 | 1099 | 1167 | 1217 | 1384 | | 60 |
| 30 X 30SQ | SMB29 | 1 | 24X24 | 1144 | 1286 | 1337 | 1517 | 1451 | 1683 | | 95 |
| 36 X 36SQ | SMB29 | 1 | 30X30 | 1444 | 1667 | 1729 | 1939 | 1947 | 2147 | | 140 |
| <i>42" high</i> | | | | | | | | | | | |
| 24 X 24SQ | SMB42 | 1 | 18X18 | 907 | 1102 | 1139 | 1207 | 1257 | 1424 | | 62 |
| 30 X 30SQ | SMB42 | 1 | 24X24 | 1182 | 1324 | 1375 | 1555 | 1489 | 1721 | | 97 |
| 36 X 36SQ | SMB42 | 1 | 30X30 | 1483 | 1706 | 1768 | 1978 | 1986 | 2186 | | 142 |
| <i>Rectangle</i> | | | | | | | | | | | |
| <i>18" high</i> | | | | | | | | | | | |
| 24 X 72 RE | SMB18 | 2 | 18X18 | 1894 | 2271 | 2357 | 2499 | 2590 | 2862 | | 180 |
| 30 X 72 RE | SMB18 | 2 | 24X24 | 2371 | 2794 | 2901 | 3117 | 3230 | 3566 | | 232 |
| 36 X 72 RE | SMB18 | 2 | 30X30 | 2865 | 3335 | 3456 | 3735 | 3871 | 4272 | | 284 |
| <i>29" high</i> | | | | | | | | | | | |
| 24 X 72 RE | SMB29 | 2 | 18X18 | 1894 | 2271 | 2357 | 2499 | 2590 | 2862 | | 182 |
| 30 X 72 RE | SMB29 | 2 | 24X24 | 2371 | 2794 | 2901 | 3117 | 3230 | 3566 | | 234 |
| 36 X 72 RE | SMB29 | 2 | 30X30 | 2865 | 3335 | 3456 | 3735 | 3871 | 4272 | | 286 |
| <i>42" high</i> | | | | | | | | | | | |
| 24 X 72 RE | SMB42 | 2 | 18X18 | 1974 | 2351 | 2437 | 2579 | 2670 | 2942 | | 185 |
| 30 X 72 RE | SMB42 | 2 | 24X24 | 2447 | 2870 | 2977 | 3193 | 3306 | 3642 | | 236 |
| 36 X 72 RE | SMB42 | 2 | 30X30 | 2943 | 3413 | 3534 | 3813 | 3949 | 4350 | | 288 |

¹ Exposed Baltic Birch plywood edge (PKNR, PF) can only be specified on tops up to 47-1/2" x 95-1/2". Clear finish only.



30X30SQ SMB29



30X72RE SMB29

STANDARD FEATURES

- Select from 15 standard laminates or choose any standard Wilsonart, Nevamar, Formica, Arborite and Pionite matte finish laminates at no upcharge. For other laminate please contact the factory for pricing.
- 9 standard veneer and hardwood edge stains. Stain-to-match available at no upcharge.
- Bases available in any Spectone color.
- Standard 18", 29" or 42" table height, please specify.
- All bases are standard with floor leveling glides.

OPTIONS

- Custom heights available.
- For applicable Power & Data modules, please see Table Accessories Price List.

HOW TO ORDER

1. Select Model
2. Select Base
3. Select Edge Style
4. Select Top Finish
5. Select Edge Finish
6. Select Base Finish

Example: 30X30SQ - SMB29 - 2MM





TRUMPET & FLAT BASE TABLES - RECTANGLE METAL BASE



| MODEL | BASES | | | TOP SPECIFICATIONS | | | | | | OPTIONS | LBS |
|------------------|-------|------|-----------|--------------------|--|--------------------|-----------------------------|------------------------|-----------------------------|---------|-----|
| | Code | Qty. | Base Size | For Laminate Top | | | For Veneer Top | | | | |
| | | | | SE PVF 2MM | HF HB PKNR ¹ PF ¹ | HBV HBVR HBG | HF2 HB2 HKNR4 HBG2 | HF HB HBV HBG | HF2 HB2 HKNR4 HBG2 | | |
| <i>Rectangle</i> | | | | | | | | | | | |
| <i>18" high</i> | | | | | | | | | | | |
| 24 X 48 RE | RMB18 | 1 | 18X42 | 1323 | 1538 | 1594 | 1695 | 1756 | 1937 | | 120 |
| 30 X 48 RE | RMB18 | 1 | 24X42 | 1540 | 1834 | 1901 | 2017 | 2103 | 2323 | | 154 |
| 36 X 48 RE | RMB18 | 1 | 30X42 | 1832 | 2144 | 2235 | 2373 | 2464 | 2735 | | 188 |
| <i>29" high</i> | | | | | | | | | | | |
| 24 X 48 RE | RMB29 | 1 | 18X42 | 1323 | 1538 | 1594 | 1695 | 1756 | 1937 | | 121 |
| 30 X 48 RE | RMB29 | 1 | 24X42 | 1540 | 1834 | 1901 | 2017 | 2103 | 2323 | | 155 |
| 36 X 48 RE | RMB29 | 1 | 30X42 | 1832 | 2144 | 2235 | 2373 | 2464 | 2735 | | 190 |
| <i>42" high</i> | | | | | | | | | | | |
| 24 X 48 RE | RMB42 | 1 | 18X42 | 1361 | 1576 | 1632 | 1733 | 1794 | 1975 | | 123 |
| 30 X 48 RE | RMB42 | 1 | 24X42 | 1578 | 1872 | 1939 | 2055 | 2141 | 2361 | | 158 |
| 36 X 48 RE | RMB42 | 1 | 30X42 | 1871 | 2183 | 2274 | 2412 | 2503 | 2774 | | 192 |

¹ Exposed Baltic Birch plywood edge (PKNR, PF) can only be specified on tops up to 47-1/2" x 95-1/2". Clear finish only.



30X48RE RMB29

STANDARD FEATURES

- Select from 15 standard laminates or choose any standard Wilsonart, Nevamar, Formica, Arborite and Pionite matte finish laminates at no upcharge. For other laminate please contact the factory for pricing.
- 9 standard veneer and hardwood edge stains. Stain-to-match available at no upcharge.
- Bases available in any Spectone color.
- Standard 18", 29" or 42" table height, please specify.
- All bases are standard with floor leveling glides.

OPTIONS

- Custom heights available.
- For applicable Power & Data modules, please see Table Accessories Price List.

HOW TO ORDER

1. Select Model
2. Select Base
3. Select Edge Style
4. Select Top Finish
5. Select Edge Finish
6. Select Base Finish

Example: 36X48RE - RMB42 - 2MM



TUBULAR TABLES



PRODUCT CODE

2430 RE T

Top Size

Width x Length

Top Shape

- D : Round
- SQ : Square
- RE : Rectangle
- RT : Racetrack
- B : Bullet
- H : Halfmoon
- TP : Trapezoid

- C90 : Radius (*connector*)
- CRC90 : Crescent (*connector*)
- BT : Boatshape
- BTA : Boatshape Arc

Base

- X : X-Base
- X4 : 4 Column X-Base
- T : T-Base
- T2 : Double Column T-Base

OPTIONS

FLIP TOP



CASTERS



FOLDING



FINISHES

LAMINATE



Select from 15 standard laminates or choose any standard Wilsonart, Nevamar, Formica, Arborite and Pionite matte finish laminates at no upcharge

VENEER

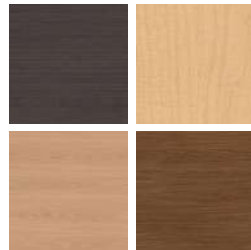

Select from one of our 9 standard wood stains or stain-to-match at no upcharge

BASE



Select from one of our 76 standard Spectone colors

EDGE



See Spectone Card or specfurniture.com/materials/finishes for a complete list of finish options and colors.

TUBULAR TABLES

HOW TO ORDER

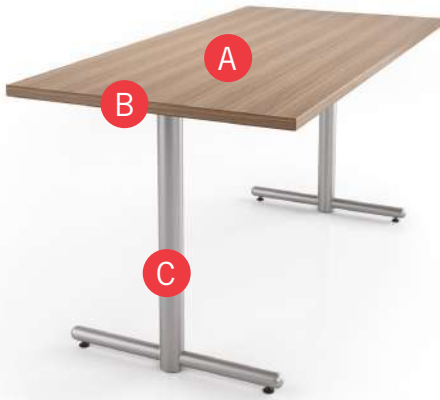

Specify Top Size (Width x Length) and Shape

- A** Specify Top Type and Finish
For Laminate Top: Manufacturer, Laminate Name, Laminate Code
For Veneer Top: Wood Stain
- B** Specify Edge Type, (for hardwood: Style), and Finish
PVC/2mm/Self Edge/Exposed Baltic Birch Plywood/Hardwood
- C** Specify Base Style and Finish

Optional: Flip Top, Fold, Hard Casters, Soft Casters, Wheelbarrow Wheels, Grommets, Seam Connectors, Modesty Panels, Adjustable Height, Power and Data Modules, Custom Solutions

Restrictions may apply. See price list tables below for more information.

| Top Size and Shape | Top Type and Finish | Edge Type and Finish | Base Style and Finish |
|--------------------|---------------------------------|--|-----------------------|
| 36 x 96, Rectangle | Laminate, Arborite, Brown Sugar | Hardwood, HF, Custom Brown Sugar Stain | T, Silver |

EDGE PROFILES

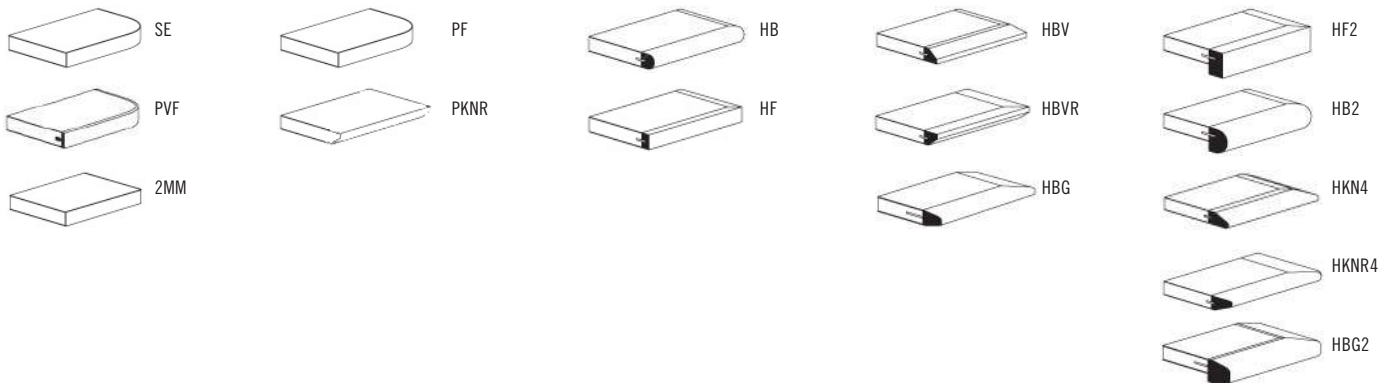



TUBULAR TABLES GENERAL PURPOSE



| MODEL | BASES | | TOP SPECIFICATIONS | | | | | | OPTIONS | | | LBS |
|---------------|-------|------|--------------------|--|--------------------|-------------------------------------|--------------------------------|-------------------------------------|---------------|---------|-----------|-----------|
| | Code | Qty. | For Laminate Top | | | For Veneer Top | | | FLIP TOP (FT) | CASTERS | | |
| | | | SE PVF 2MM | HF HB PKNR ¹ PF ¹ | HBV HBVR HBG | HF2 HB2 HKN4 HKNR4 HBG2 | HF HB HBV HBVR HBG | HF2 HB2 HKN4 HKNR4 HBG2 | | | HARD (HC) | SOFT (SC) |
| <i>Round</i> | | | | | | | | | | | | |
| 24D | X | 1 | 520 | 880 | 917 | 1026 | 1085 | 1197 | 154 | | | 37 |
| 30D | X | 1 | 624 | 979 | 1026 | 1244 | 1189 | 1353 | 154 | | | 47 |
| 36D | X | 1 | 723 | 1236 | 1327 | 1505 | 1559 | 1788 | 154 | | | 58 |
| 42D | X | 1 | 1008 | 1584 | 1708 | 1973 | 1999 | 2312 | 154 | | | 72 |
| | X4 | 1 | 1204 | 1780 | 1904 | 2169 | 2195 | 2508 | | 96 | 204 | 87 |
| 48D | X | 1 | 1031 | 1804 | 1939 | 2071 | 2545 | 2947 | 154 | 96 | 204 | 88 |
| | X4 | 1 | 1227 | 2000 | 2135 | 2267 | 2741 | 3143 | | 96 | 204 | 103 |
| 54D | X4 | 1 | 1517 | 2657 | 2867 | 3067 | 3303 | 3819 | | | | 121 |
| 60D | X4 | 1 | 1565 | 2859 | 3083 | 3252 | 3938 | 4579 | | | | 140 |
| <i>Square</i> | | | | | | | | | | | | |
| 24 x 24SQ | X | 1 | 551 | 746 | 783 | 851 | 901 | 1068 | 154 | 96 | 204 | 37 |
| 30 x 30SQ | X | 1 | 658 | 800 | 851 | 1031 | 965 | 1197 | 154 | 96 | 204 | 47 |
| 36 x 36SQ | X | 1 | 741 | 964 | 1026 | 1236 | 1244 | 1444 | 154 | 96 | 204 | 58 |
| 42 x 42SQ | X | 1 | 1176 | 1499 | 1598 | 1698 | 1767 | 2040 | 310 | | | 92 |
| | X4 | 1 | 1218 | 1541 | 1640 | 1740 | 1809 | 2082 | | 96 | 204 | 87 |
| 48 x 48SQ | X4 | 1 | 1372 | 1655 | 1760 | 1807 | 2185 | 2538 | | 96 | 204 | 103 |
| 54 x 54SQ | X4 | 1 | 1520 | 2144 | 2308 | 2498 | 2602 | 3059 | | | | 121 |
| 60 x 60SQ | X4 | 1 | 1550 | 2250 | 2425 | 2616 | 3081 | 3634 | | | | 140 |

¹ Exposed Baltic Birch plywood edge (PKNR, PF) can only be specified on square tops up to 47-1/2" x 95-1/2". Clear finish only.



STANDARD FEATURES

- Select from 15 standard laminates or choose any standard Wilsonart, Nevamar, Formica, Arborite and Pionite matte finish laminates at no upcharge. For other laminate please contact the factory for pricing.
- 9 standard veneer and hardwood edge stains. Stain-to-match available at no upcharge.
- Bases available in any Spectone color.
- Standard table height 29".
- All bases are standard with floor leveling glides.

OPTIONS

- Custom heights available.

HOW TO ORDER

1. Select Model
2. Select Base
3. Select Edge Style
4. Select Options
5. Select Top Finish
6. Select Edge Finish
7. Select Base Finish

Example: 24D - X - PVF -





TUBULAR TABLES

GENERAL PURPOSE

| MODEL | BASES | | TOP SPECIFICATIONS | | | | | | OPTIONS | | | | LBS |
|------------------|-------|------|--------------------|--|--------------------|-------------------------------------|--------------------------------|-------------------------------------|---------------|------------|---------|-----|-----------|
| | Code | Qty. | For Laminate Top | | | For Veneer Top | | | FLIP TOP (FT) | FOLD* (FL) | CASTERS | | |
| | | | SE PVF 2MM | HF HB PKNR ¹ PF ¹ | HBV HBVR HBG | HF2 HB2 HKN4 HKNR4 HBG2 | HF HB HBV HBVR HBG | HF2 HB2 HKN4 HKNR4 HBG2 | | | | | HARD (HC) |
| <i>Rectangle</i> | | | | | | | | | | | | | |
| 24 x 30RE | X | 1 | 647 | 779 | 828 | 896 | 949 | 1080 | 154 | | | | 46 |
| | T | 2 | 758 | 890 | 939 | 1007 | 1060 | 1191 | 310 | | 96 | 204 | 54 |
| 24 x 36RE | X | 1 | 647 | 779 | 828 | 896 | 949 | 1080 | 154 | | | | 46 |
| | T | 2 | 758 | 890 | 939 | 1007 | 1060 | 1191 | 310 | | 96 | 204 | 54 |
| 24 x 42RE | T | 2 | 823 | 1038 | 1094 | 1195 | 1256 | 1437 | 310 | | 96 | 204 | 62 |
| 24 x 48RE | T | 2 | 823 | 1038 | 1094 | 1195 | 1256 | 1437 | 310 | | 96 | 204 | 62 |
| 24 x 54RE | T | 2 | 884 | 1197 | 1267 | 1383 | 1470 | 1692 | 310 | | 96 | 204 | 70 |
| 24 x 60RE | T | 2 | 884 | 1197 | 1267 | 1383 | 1470 | 1692 | 310 | 297 | 96 | 204 | 70 |
| 24 x 66RE | T | 2 | 1032 | 1409 | 1495 | 1637 | 1728 | 2000 | 310 | 297 | 96 | 204 | 79 |
| 24 x 72RE | T | 2 | 1032 | 1409 | 1495 | 1637 | 1728 | 2000 | 310 | 297 | 96 | 204 | 79 |
| 30 x 36RE | X | 1 | 741 | 896 | 950 | 1039 | 1101 | 1259 | 154 | | | | 52 |
| | T | 2 | 852 | 1007 | 1061 | 1150 | 1212 | 1370 | 310 | | 96 | 204 | 60 |
| 30 x 42RE | X | 1 | 763 | 1057 | 1124 | 1240 | 1326 | 1546 | 154 | | | | 62 |
| | T | 2 | 874 | 1168 | 1235 | 1351 | 1437 | 1657 | 310 | | 96 | 204 | 70 |
| 30 x 48RE | X | 1 | 763 | 1057 | 1124 | 1240 | 1326 | 1546 | 154 | | | | 62 |
| | T | 2 | 874 | 1168 | 1235 | 1351 | 1437 | 1657 | 310 | | 96 | 204 | 70 |
| 30 x 54RE | T | 2 | 935 | 1335 | 1422 | 1588 | 1686 | 1962 | 310 | | 96 | 204 | 81 |
| 30 x 60RE | T | 2 | 935 | 1335 | 1422 | 1588 | 1686 | 1962 | 310 | 297 | 96 | 204 | 81 |
| 30 x 66RE | T | 2 | 1111 | 1436 | 1542 | 1709 | 1805 | 2110 | 310 | 297 | 96 | 204 | 91 |
| 30 x 72RE | T | 2 | 1169 | 1592 | 1699 | 1915 | 2028 | 2364 | 310 | 297 | 96 | 204 | 91 |



*Folding tables available with PVC Flat (PVF) edge only.

¹ Exposed Baltic Birch plywood edge (PKNR, PF) can only be specified on tops up to 47-1/2" x 95-1/2". Clear finish only.



2448RE-T
STANDARD FEATURES

- Select from 15 standard laminates or choose any standard Wilsonart, Nevamar, Formica, Arborite and Pionite matte finish laminates at no upcharge. For other laminate please contact the factory for pricing.
- 9 standard veneer and hardwood edge stains. Stain-to-match available at no upcharge.
- Bases available in any Spectone color.
- Standard table height 29".
- All bases are standard with floor leveling glides.

OPTIONS

- Custom heights available.

HOW TO ORDER

1. Select Model
2. Select Base
3. Select Edge Style
4. Select Options
5. Select Top Finish
6. Select Edge Finish
7. Select Base Finish

Example: 2430RE - X - PVF -





TUBULAR TABLES

GENERAL PURPOSE

| MODEL | BASES | | TOP SPECIFICATIONS | | | | | | OPTIONS | | | | LBS |
|------------------|-------|------|--------------------|--|--------------------|-------------------------------------|--------------------------------|-------------------------------------|---------------|------------|---------|-----|-----------|
| | Code | Qty. | For Laminate Top | | | For Veneer Top | | | FLIP TOP (FT) | FOLD* (FL) | CASTERS | | |
| | | | SE PVF 2MM | HF HB PKNR ¹ PF ¹ | HBV HBVR HBG | HF2 HB2 HKN4 HKNR4 HBG2 | HF HB HBV HBVR HBG | HF2 HB2 HKN4 HKNR4 HBG2 | | | | | HARD (HC) |
| <i>Rectangle</i> | | | | | | | | | | | | | |
| 30 x 78RE | T | 2 | 1397 | 1772 | 1899 | 2150 | 2282 | 2668 | 310 | 297 | 96 | 204 | 102 |
| 30 x 84RE | T | 2 | 1397 | 1772 | 1899 | 2150 | 2282 | 2668 | 310 | 297 | 96 | 204 | 102 |
| 30 x 90RE | T | 2 | 1419 | 1997 | 2150 | 2382 | 2538 | 2978 | | 297 | 96 | 204 | 112 |
| 30 x 96RE | T | 2 | 1419 | 1997 | 2150 | 2382 | 2538 | 2978 | | 297 | 96 | 204 | 112 |
| 36 x 42RE | T | 2 | 976 | 1197 | 1281 | 1396 | 1486 | 1717 | 310 | | 96 | 204 | 79 |
| 36 x 48RE | T | 2 | 1001 | 1313 | 1404 | 1542 | 1633 | 1904 | 310 | | 96 | 204 | 79 |
| 36 x 60RE | T | 2 | 1100 | 1534 | 1644 | 1820 | 1931 | 2269 | 310 | 297 | 96 | 204 | 91 |
| 36 x 66RE | T | 2 | 1190 | 1640 | 1767 | 1960 | 2082 | 2453 | 310 | 297 | 96 | 204 | 104 |
| | T2 | 2 | 1394 | 1844 | 1971 | 2164 | 2286 | 2657 | | 597 | 96 | 204 | 124 |
| 36 x 72RE | T | 2 | 1229 | 1699 | 1820 | 2099 | 2235 | 2636 | 310 | 297 | 96 | 204 | 104 |
| | T2 | 2 | 1433 | 1903 | 2024 | 2303 | 2439 | 2840 | | 597 | 96 | 204 | 124 |
| 36 x 78RE | T | 2 | 1570 | 2073 | 2231 | 2474 | 2632 | 3105 | | 297 | 96 | 204 | 117 |
| | T2 | 2 | 1774 | 2277 | 2435 | 2678 | 2836 | 3309 | | 597 | 96 | 204 | 137 |
| 36 x 84RE | T | 2 | 1570 | 2073 | 2231 | 2474 | 2632 | 3105 | | 297 | 96 | 204 | 117 |
| | T2 | 2 | 1774 | 2277 | 2435 | 2678 | 2836 | 3309 | | 597 | 96 | 204 | 137 |
| 36 x 90RE | T | 2 | 1577 | 2294 | 2474 | 2757 | 2939 | 3463 | | | 96 | 204 | 129 |
| | T2 | 2 | 1781 | 2498 | 2678 | 2961 | 3143 | 3667 | | 597 | 96 | 204 | 149 |
| 36 x 96RE | T | 2 | 1577 | 2294 | 2474 | 2757 | 2939 | 3463 | | | 96 | 204 | 129 |
| | T2 | 2 | 1781 | 2498 | 2678 | 2961 | 3143 | 3667 | | 597 | 96 | 204 | 149 |
| 42 x 78RE | T2 | 2 | 2022 | 2454 | 2627 | 3045 | 3182 | 3730 | | 597 | 96 | 204 | 151 |
| 42 x 84RE | T2 | 2 | 2022 | 2454 | 2627 | 3045 | 3182 | 3730 | | 597 | 96 | 204 | 151 |

*Folding tables available with PVC Flat (PVF) edge only.

¹ Exposed Baltic Birch plywood edge (PKNR, PF) can only be specified on tops up to 47-1/2" x 95-1/2". Clear finish only.



2448RE-T

STANDARD FEATURES

- Select from 15 standard laminates or choose any standard Wilsonart, Nevamar, Formica, Arborite and Pionite matte finish laminates at no upcharge. For other laminate please contact the factory for pricing.
- 9 standard veneer and hardwood edge stains. Stain-to-match available at no upcharge.
- Bases available in any Spectone color.
- Standard table height 29".
- All bases are standard with floor leveling glides.

OPTIONS

- Custom heights available.

HOW TO ORDER

1. Select Model
2. Select Base
3. Select Edge Style
4. Select Options
5. Select Top Finish
6. Select Edge Finish
7. Select Base Finish

Example: 3078RE - T - PVF -





TUBULAR TABLES

GENERAL PURPOSE

| MODEL | BASES | | TOP SPECIFICATIONS | | | | | | OPTIONS | | | LBS |
|------------------|-------|------|--------------------|----------|--------------------|-------------------------------------|--------------------------------|-------------------------------------|---------------|---------|-----------|-----------|
| | Code | Qty. | For Laminate Top | | | For Veneer Top | | | FLIP TOP (FT) | CASTERS | | |
| | | | SE PVF 2MM | HF HB | HBV HBVR HBG | HF2 HB2 HKN4 HKNR4 HBG2 | HF HB HBV HBVR HBG | HF2 HB2 HKN4 HKNR4 HBG2 | | | HARD (HC) | SOFT (SC) |
| <i>Racetrack</i> | | | | | | | | | | | | |
| 36 x 54RT | T | 2 | 1157 | 1728 | 1861 | 2099 | 2197 | 2546 | 310 | 96 | 204 | 91 |
| | T2 | 2 | 1361 | 1932 | 2065 | 2303 | 2401 | 2750 | | 96 | 204 | 111 |
| 36 x 60RT | T | 2 | 1157 | 1728 | 1861 | 2099 | 2197 | 2546 | 310 | 96 | 204 | 91 |
| | T2 | 2 | 1361 | 1932 | 2065 | 2303 | 2401 | 2750 | | 96 | 204 | 111 |
| 36 x 66RT | T | 2 | 1318 | 1915 | 2059 | 2314 | 2538 | 2974 | 310 | 96 | 204 | 104 |
| | T2 | 2 | 1522 | 2119 | 2263 | 2518 | 2742 | 3178 | | 96 | 204 | 124 |
| 36 x 72RT | T | 2 | 1318 | 1915 | 2059 | 2314 | 2538 | 2974 | 310 | 96 | 204 | 104 |
| | T2 | 2 | 1522 | 2119 | 2263 | 2518 | 2742 | 3178 | | 96 | 204 | 124 |
| 36 x 78RT | T | 2 | 1588 | 2346 | 2523 | 2908 | 2989 | 3497 | | 96 | 204 | 117 |
| | T2 | 2 | 1792 | 2550 | 2727 | 3112 | 3193 | 3701 | | 96 | 204 | 132 |
| 36 x 84RT | T | 2 | 1588 | 2346 | 2523 | 2908 | 2989 | 3497 | | 96 | 204 | 117 |
| | T2 | 2 | 1792 | 2550 | 2727 | 3112 | 3193 | 3701 | | 96 | 204 | 132 |
| 36 x 90RT | T | 2 | 1592 | 2603 | 2814 | 3245 | 3346 | 3925 | | 96 | 204 | 129 |
| | T2 | 2 | 1796 | 2807 | 3018 | 3449 | 3550 | 4129 | | 96 | 204 | 149 |
| 36 x 96RT | T | 2 | 1592 | 2603 | 2814 | 3245 | 3346 | 3925 | | 96 | 204 | 129 |
| | T2 | 2 | 1796 | 2807 | 3018 | 3449 | 3550 | 4129 | | 96 | 204 | 149 |
| 42 x 78RT | T2 | 2 | 2037 | 2754 | 2971 | 3407 | 3512 | 4096 | | 96 | 204 | 166 |
| 42 x 84RT | T2 | 2 | 2037 | 2754 | 2971 | 3407 | 3512 | 4096 | | 96 | 204 | 166 |
| 48 x 78RT | T2 | 2 | 2040 | 3062 | 3308 | 3694 | 3935 | 4599 | | 96 | 204 | 166 |
| 48 x 84RT | T2 | 2 | 2040 | 3062 | 3308 | 3694 | 3935 | 4599 | | 96 | 204 | 166 |



2448RE-T

STANDARD FEATURES

- Select from 15 standard laminates or choose any standard Wilsonart, Nevamar, Formica, Arborite and Pionite matte finish laminates at no upcharge. For other laminate please contact the factory for pricing.
- 9 standard veneer and hardwood edge stains. Stain-to-match available at no upcharge.
- Bases available in any Spectone color.
- Standard table height 29".
- All bases are standard with floor leveling glides.

OPTIONS

- Custom heights available.

HOW TO ORDER

1. Select Model
2. Select Base
3. Select Edge Style
4. Select Options
5. Select Top Finish
6. Select Edge Finish
7. Select Base Finish

Example: 3654RT - T - PVF -





TUBULAR TABLES

GENERAL PURPOSE



| MODEL | BASES | | TOP SPECIFICATIONS | | | | | | OPTIONS | | | LBS |
|-----------------------------|-------------|------|--------------------|-------|---------|-------------------------|--------------------|-------------------------|---------------|---------|-----------|-----------|
| | Code | Qty. | For Laminate Top | | | For Veneer Top | | | FLIP TOP (FT) | CASTERS | | |
| | | | SE PVF 2MM | HF HB | HBV HBG | HF2 HB2 HKN4 HKNR4 HBG2 | HF HB HBV HBVR HBG | HF2 HB2 HKN4 HKNR4 HBG2 | | | HARD (HC) | SOFT (SC) |
| <i>Bullet</i> | | | | | | | | | | | | |
| 30 x 54B | T | 2 | 1056 | 1625 | 1744 | 1952 | 2014 | 2358 | 310 | 96 | 204 | 81 |
| 30 x 60B | T | 2 | 1056 | 1625 | 1744 | 1952 | 2014 | 2358 | 310 | 96 | 204 | 81 |
| 36 x 54B | T | 2 | 1179 | 2136 | 2305 | 2610 | 2652 | 3085 | 310 | 96 | 204 | 91 |
| 36 x 60B | T | 2 | 1179 | 2136 | 2305 | 2610 | 2652 | 3085 | 310 | 96 | 204 | 91 |
| 36 x 72B | T | 2 | 1317 | 2375 | 2562 | 2888 | 3077 | 3621 | 310 | 96 | 204 | 104 |
| <i>Halfmoon</i> | | | | | | | | | | | | |
| 24 x 48H | T | 2 | 841 | 1355 | 1484 | 1640 | 1767 | 2059 | 310 | 96 | 204 | 62 |
| 30 x 60H | T | 2 | 1056 | 1821 | 1998 | 2174 | 2394 | 2811 | 310 | 96 | 204 | 81 |
| 36 x 72H | T | 2 | 1317 | 2361 | 2592 | 2808 | 3165 | 3729 | 310 | 96 | 204 | 104 |
| <i>Trapezoid</i> | | | | | | | | | | | | |
| 30 x 60TP | T | 2 | 1056 | 1527 | 1637 | 1826 | 1881 | 2200 | 310 | 96 | 204 | 81 |
| 36 x 72TP | T | 2 | 1317 | 1956 | 2100 | 2428 | 2510 | 2970 | 310 | 96 | 204 | 104 |
| <i>Radius (connector)</i> | | | | | | | | | | | | |
| 24 x 24 | 24RC90 | - | 395 | 717 | 810 | 929 | 952 | 1140 | | | | 17 |
| 30 x 30 | 30RC90 | - | 504 | 948 | 1066 | 1195 | 1263 | 1515 | | | | 27 |
| <i>Crescent (connector)</i> | | | | | | | | | | | | |
| 30 x 36 | 3036CRC90-T | 1 | 805 | 1491 | 1578 | 1646 | 1864 | 2103 | | | | 46 |
| 36 x 42 | 3642CRC90-T | 1 | 1168 | 1812 | 1931 | 2020 | 2320 | 2644 | | | | 59 |



2448RE-T

STANDARD FEATURES

- Select from 15 standard laminates or choose any standard Wilsonart, Nevamar, Formica, Arborite and Pionite matte finish laminates at no upcharge. For other laminate please contact the factory for pricing.
- 9 standard veneer and hardwood edge stains. Stain-to-match available at no upcharge.
- Bases available in any Spectone color.
- Standard table height 29".
- All bases are standard with floor leveling glides.

OPTIONS

- Custom heights available.

HOW TO ORDER

1. Select Model
2. Select Base
3. Select Edge Style
4. Select Options
5. Select Top Finish
6. Select Edge Finish
7. Select Base Finish

Example: 3054B - T - PVF -





TUBULAR TABLES BOARDROOM



| MODEL | BASES | | TOP SPECIFICATIONS | | | | | | OPTIONS | LBS |
|------------------|-------|------|--------------------|--|--------------------|-------------------------------------|--------------------------------|-------------------------------------|---------|-----|
| | Code | Qty. | For Laminate Top | | | For Veneer Top | | | | |
| | | | SE PVF 2MM | HF HB PKNR ¹ PF ¹ | HBV HBVR HBG | HF2 HB2 HKN4 HKNR4 HBG2 | HF HB HBV HBVR HBG | HF2 HB2 HKN4 HKNR4 HBG2 | | |
| <i>Rectangle</i> | | | | | | | | | | |
| 42 x 96RE | T2 | 2 | 2075 | 2985 | 3231 | 3480 | 3848 | 4560 | | 183 |
| 48 x 96RE | T2 | 2 | 2075 | 2985 | 3231 | 3480 | 3848 | 4560 | | 183 |
| 48 x 120RE | T2 | 3 | 2741 | 3916 | 4194 | 4795 | 4883 | 5716 | | 240 |
| 48 x 144RE | T2 | 3 | 3137 | 4822 | 5189 | 5760 | 5624 | 6626 | | 274 |
| 48 x 168RE | T2 | 3 | 3641 | 5337 | 5756 | 6553 | 6369 | 7533 | | 308 |
| 60 x 120RE | T2 | 3 | 3225 | 4982 | 5366 | 5958 | 5817 | 6862 | | 282 |
| 60 x 144RE | T2 | 3 | 3673 | 5782 | 6241 | 6952 | 6784 | 8037 | | 324 |
| 60 x 168RE | T2 | 3 | 4123 | 6582 | 7116 | 7948 | 7751 | 9211 | | 366 |
| <i>Racetrack</i> | | | | | | | | | | |
| 42 x 96RT | T2 | 2 | 2095 | 3124 | 3375 | 3978 | 4404 | 5163 | | 183 |
| 48 x 96RT | T2 | 2 | 2095 | 3124 | 3375 | 3978 | 4404 | 5163 | | 183 |
| 48 x 120RT | T2 | 3 | 2768 | 4400 | 4727 | 5558 | 5523 | 6410 | | 240 |
| 48 x 144RT | T2 | 3 | 3167 | 5200 | 5601 | 6631 | 6392 | 7468 | | 274 |
| 48 x 168RT | T2 | 3 | 3673 | 5884 | 6352 | 7496 | 7274 | 8521 | | 308 |
| 60 x 120RT | T2 | 3 | 3214 | 5254 | 5660 | 6704 | 6657 | 7770 | | 282 |
| 60 x 144RT | T2 | 3 | 3713 | 6254 | 6757 | 8047 | 7746 | 9090 | | 324 |
| 60 x 168RT | T2 | 3 | 4348 | 7113 | 7697 | 9123 | 8847 | 10405 | | 366 |

¹ Exposed Baltic Birch plywood edge (PKNR, PF) can only be specified on rectangle tops up to 47-1/2" x 95-1/2". Clear finish only.



4296BTA-T2

STANDARD FEATURES

- Select from 15 standard laminates or choose any standard Wilsonart, Nevamar, Formica, Arborite and Pionite matte finish laminates at no upcharge. For other laminate please contact the factory for pricing.
- 9 standard veneer and hardwood edge stains. Stain-to-match available at no upcharge.
- Bases available in any Spectone color.
- Standard table height 29".
- All bases are standard with floor leveling glides.

OPTIONS

- Custom heights available.

HOW TO ORDER

1. Select Model
2. Select Base
3. Select Edge Style
4. Select Top Finish
5. Select Edge Finish
6. Select Base Finish

Example: 4296RE - T2 - PVF





TUBULAR TABLES BOARDROOM



| MODEL | BASES | | TOP SPECIFICATIONS | | | | | | OPTIONS | LBS |
|------------------|-------|------|--------------------|----------|--------------------|-------------------------------------|--------------------------------|-------------------------------------|---------|-----|
| | Code | Qty. | For Laminate Top | | | For Veneer Top | | | | |
| | | | SE PVF 2MM | HF HB | HBV HBVR HBG | HF2 HB2 HKN4 HKNR4 HBG2 | HF HB HBV HBVR HBG | HF2 HB2 HKN4 HKNR4 HBG2 | | |
| <i>Boatshape</i> | | | | | | | | | | |
| 42 x 96BT | T2 | 2 | 2095 | 3826 | 4148 | 4480 | 4951 | 5365 | | 183 |
| 48 x 96BT | T2 | 2 | 2095 | 3826 | 4148 | 4480 | 4951 | 5365 | | 183 |
| 48 x 120BT | T2 | 3 | 2768 | 5169 | 5568 | 5990 | 6169 | 6648 | | 240 |
| 48 x 144BT | T2 | 3 | 3167 | 5970 | 6446 | 6952 | 7590 | 8025 | | 274 |
| 48 x 168BT | T2 | 3 | 3673 | 6735 | 7290 | 7874 | 8172 | 8844 | | 308 |
| 60 x 120BT | T2 | 3 | 3214 | 6213 | 6716 | 7242 | 7468 | 8062 | | 282 |
| 60 x 144BT | T2 | 3 | 3713 | 7218 | 7813 | 8446 | 9241 | 9787 | | 324 |
| 60 x 168BT | T2 | 3 | 4348 | 8176 | 8867 | 9598 | 9968 | 10810 | | 366 |
| <i>Boatshape</i> | | | | | | | | | | |
| <i>Arc Ends</i> | | | | | | | | | | |
| 42 x 96BTA | T2 | 2 | 2271 | 4377 | 4701 | 5035 | 5503 | 5917 | | 183 |
| 48 x 96BTA | T2 | 2 | 2271 | 4377 | 4701 | 5035 | 5503 | 5917 | | 183 |
| 48 x 120BTA | T2 | 3 | 2943 | 5723 | 6123 | 6545 | 6724 | 7199 | | 240 |
| 48 x 144BTA | T2 | 3 | 3343 | 6521 | 7001 | 7507 | 8141 | 8579 | | 274 |
| 48 x 168BTA | T2 | 3 | 3850 | 7290 | 7845 | 8429 | 8725 | 9400 | | 308 |
| 60 x 120BTA | T2 | 3 | 3435 | 6908 | 7407 | 7934 | 8158 | 8753 | | 282 |
| 60 x 144BTA | T2 | 3 | 3932 | 7907 | 8506 | 9137 | 9933 | 10476 | | 324 |
| 60 x 168BTA | T2 | 3 | 4567 | 8867 | 9559 | 10288 | 10661 | 11505 | | 366 |



4296BTA-T2

STANDARD FEATURES

- Select from 15 standard laminates or choose any standard Wilsonart, Nevamar, Formica, Arborite and Pionite matte finish laminates at no upcharge. For other laminate please contact the factory for pricing.
- 9 standard veneer and hardwood edge stains. Stain-to-match available at no upcharge.
- Bases available in any Spectone color.
- Standard table height 29".
- All bases are standard with floor leveling glides.

OPTIONS

- Custom heights available.

HOW TO ORDER

1. Select Model
2. Select Base
3. Select Edge Style
4. Select Top Finish
5. Select Edge Finish
6. Select Base Finish

Example: 4296BT - T2 - PVF



VARSITY TABLES



PRODUCT CODE

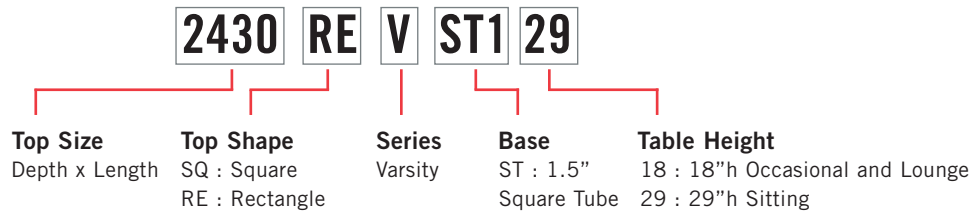

OPTIONS

SEAM CONNECTORS



CASTERS



1.5" Low Profile Locking Caster

FINISHES

LAMINATE



Select from 15 standard laminates or choose any standard Wilsonart, Nevamar, Formica, Arborite and Pionite matte finish laminates at no upcharge

VENEER



Select from one of our 9 standard wood stains or stain-to-match at no upcharge

BASE



Select from one of our 76 standard Spectone colors

EDGE

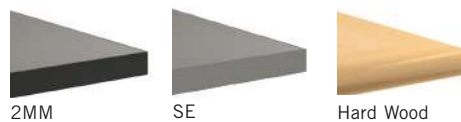

Check out our website for a complete list of edge profiles.

See Spectone Card or specfurniture.com/materials/finishes for a complete list of finish options and colors.

VARSITY TABLES

BACK TO CONTENTS

HOW TO ORDER

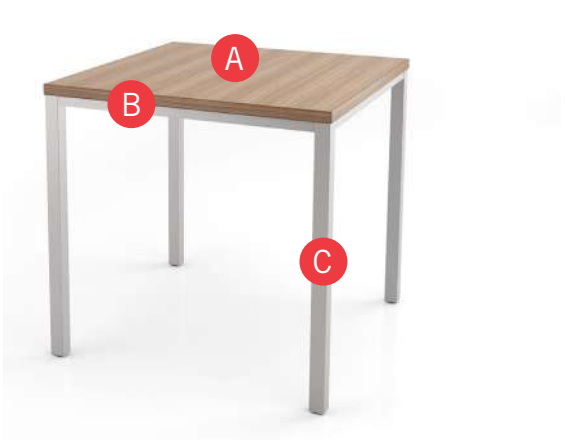

Specify Top Size (Width x Length) and Shape

- A** Specify Top Type and Finish
For Laminate Top: Manufacturer, Laminate Name, Laminate Code
For Veneer Top: Wood Stain
- B** Specify Edge Type and Finish
2mm Bio/2mm PVC Woodgrain/Self Edge/Hardwood
- C** Specify Base Style and Finish

Optional: Seam Connectors, Casters, Power and Data Modules

| Top Size and Shape | Top Type and Finish | Edge Type and Finish | Base Style and Finish |
|--------------------|---------------------------------|--|-----------------------|
| 36 x 36, Square | Laminate, Arborite, Brown Sugar | Hardwood, HF, Custom Brown Sugar Stain | VST129, Silver |





VARSITY TABLES

OCCASIONAL AND LOUNGE



| MODEL | BASES | | TOP SPECIFICATIONS | | | OPTIONS | MOBILITY | LBS |
|------------------|--------|------|--------------------|------|----------------|---------|----------|-----|
| | Code | Qty. | For Laminate Top | | For Veneer Top | | | |
| | | | SE 2MM | HF | HF | | | |
| <i>Square</i> | | | | | | | | |
| 24 X 24SQ | VST118 | 1 | 865 | 1060 | 1215 | | | 54 |
| 30 X 30SQ | VST118 | 1 | 972 | 1114 | 1279 | | | 64 |
| 36 X 36SQ | VST118 | 1 | 1055 | 1278 | 1558 | | | 76 |
| <i>Rectangle</i> | | | | | | | | |
| 24 X 48RE | VST118 | 1 | 1026 | 1241 | 1459 | | | 72 |



REVST118



SQVST118

STANDARD FEATURES

- Select from 15 standard laminates or choose any standard Wilsonart, Nevamar, Formica, Arborite and Pionite matte finish laminates at no upcharge. For other laminate please contact the factory for pricing.
- 9 standard veneer and hardwood edge stains. Stain-to-match available at no upcharge.
- Standard with leveling glides.
- Bases available in any Spectone color.
- Standard 18" table height.
- 1" apron; 1.5" square tube legs; 1" top
- Ships Knocked Down.

OPTIONS

- For Seam Connectors see the end of this section.
- For applicable Power & Data modules and cable management, please see Table Accessories Price List.

HOW TO ORDER

1. Select Model
2. Select Base
3. Select Edge Style
4. Select Options
5. Select Top Finish
6. Select Edge Finish
7. Select Base Finish

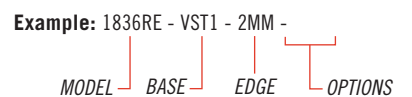



BACK TO CONTENTS

VARSITY TABLES

GENERAL PURPOSE



| MODEL | BASES | | TOP SPECIFICATIONS | | | OPTIONS | MOBILITY | | LBS |
|------------------|--------|------|--------------------|------|----------------|---------|-------------|-------------|-----|
| | Code | Qty. | For Laminate Top | | For Veneer Top | | CASTERS | | |
| | | | SE 2MM | HF | HF | | HARD Add | SOFT Add | |
| <i>Square</i> | | | | | | | | | |
| 24 X 24SQ | VST129 | 1 | 865 | 1060 | 1215 | | 96 | 204 | 54 |
| 30 X 30SQ | VST129 | 1 | 972 | 1114 | 1279 | | 96 | 204 | 64 |
| 36 X 36SQ | VST129 | 1 | 1055 | 1278 | 1558 | | 96 | 204 | 76 |
| <i>Rectangle</i> | | | | | | | | | |
| 18 X 24RE | VST129 | 1 | 811 | 903 | 992 | | 96 | 204 | 49 |
| 18 X 30RE | VST129 | 1 | 851 | 964 | 1078 | | 96 | 204 | 53 |
| 18 X 36RE | VST129 | 1 | 907 | 1050 | 1199 | | 96 | 204 | 56 |
| 18 X 42RE | VST129 | 1 | 981 | 1171 | 1361 | | 96 | 204 | 60 |
| 18 X 48RE | VST129 | 1 | 981 | 1171 | 1361 | | 96 | 204 | 64 |
| 18 X 54RE | VST129 | 1 | 1026 | 1241 | 1459 | | 96 | 204 | 68 |
| 18 X 60RE | VST129 | 1 | 1026 | 1241 | 1459 | | 96 | 204 | 72 |
| 18 X 66RE | VST129 | 1 | 1087 | 1400 | 1673 | | 96 | 204 | 75 |
| 18 X 72RE | VST129 | 1 | 1087 | 1400 | 1673 | | 96 | 204 | 79 |
| 24 X 30RE | VST129 | 1 | 961 | 1093 | 1263 | | 96 | 204 | 58 |
| 24 X 36RE | VST129 | 1 | 961 | 1093 | 1263 | | 96 | 204 | 63 |
| 24 X 42RE | VST129 | 1 | 1026 | 1241 | 1459 | | 96 | 204 | 68 |
| 24 X 48RE | VST129 | 1 | 1026 | 1241 | 1459 | | 96 | 204 | 72 |
| 24 X 54RE | VST129 | 1 | 1087 | 1400 | 1673 | | 96 | 204 | 77 |
| 24 X 60RE | VST129 | 1 | 1087 | 1400 | 1673 | | 96 | 204 | 82 |
| 24 X 66RE | VST129 | 1 | 1235 | 1612 | 1931 | | 96 | 204 | 86 |
| 24 X 72RE | VST129 | 1 | 1235 | 1612 | 1931 | | 96 | 204 | 91 |



REVST129



SQVST129

STANDARD FEATURES

- Select from 15 standard laminates or choose any standard Wilsonart, Nevamar, Formica, Arborite and Pionite matte finish laminates at no upcharge. For other laminate please contact the factory for pricing.
- 9 standard veneer and hardwood edge stains. Stain-to-match available at no upcharge.
- Standard with leveling glides.
- Bases available in any Spectone color.
- Standard 29" table height.
- 1" apron; 1.5" square tube legs; 1" top
- Ships Knocked Down.

OPTIONS

- For Seam Connectors see the end of this section.
- For applicable Power & Data modules and cable management, please see Table Accessories Price List.
- Low profile 1.5"D locking casters.

HOW TO ORDER

1. Select Model
2. Select Base
3. Select Edge Style
4. Select Options
5. Select Top Finish
6. Select Edge Finish
7. Select Base Finish

Example: 1836RE - VST1 - 2MM -





VARSITY TABLES

GENERAL PURPOSE



| MODEL | BASES | | TOP SPECIFICATIONS | | | OPTIONS | MOBILITY | | LBS |
|------------------|--------|------|--------------------|------|----------------|---------|----------|------|-----|
| | Code | Qty. | For Laminate Top | | For Veneer Top | | CASTERS | | |
| | | | SE 2MM | HF | HF | | HARD | SOFT | |
| | | | | | | | Add | Add | |
| <i>Rectangle</i> | | | | | | | | | |
| 30 X 36RE | VST129 | 1 | 1055 | 1210 | 1415 | | 96 | 204 | 69 |
| 30 X 42RE | VST129 | 1 | 1077 | 1371 | 1640 | | 96 | 204 | 75 |
| 30 X 48RE | VST129 | 1 | 1077 | 1371 | 1640 | | 96 | 204 | 81 |
| 30 X 54RE | VST129 | 1 | 1138 | 1538 | 1889 | | 96 | 204 | 86 |
| 30 X 60RE | VST129 | 1 | 1138 | 1538 | 1889 | | 96 | 204 | 92 |
| 30 X 66RE | VST129 | 1 | 1314 | 1639 | 2008 | | 96 | 204 | 97 |
| 30 X 72RE | VST129 | 1 | 1372 | 1795 | 2231 | | 96 | 204 | 103 |
| 36 X 42RE | VST129 | 1 | 1179 | 1400 | 1689 | | 96 | 204 | 82 |
| 36 X 48RE | VST129 | 1 | 1204 | 1516 | 1836 | | 96 | 204 | 89 |
| 36 X 54RE | VST129 | 1 | 1284 | 1621 | 1995 | | 96 | 204 | 95 |
| 36 X 60RE | VST129 | 1 | 1303 | 1737 | 2134 | | 96 | 204 | 102 |
| 36 X 66RE | VST129 | 1 | 1393 | 1843 | 2285 | | 96 | 204 | 108 |
| 36 X 72RE | VST129 | 1 | 1432 | 1902 | 2438 | | 96 | 204 | 115 |



REVST129



SQVST129

STANDARD FEATURES

- Select from 15 standard laminates or choose any standard Wilsonart, Nevamar, Formica, Arborite and Pionite matte finish laminates at no upcharge. For other laminate please contact the factory for pricing.
- 9 standard veneer and hardwood edge stains. Stain-to-match available at no upcharge.
- Standard with leveling glides.
- Bases available in any Spectone color.
- Standard 29" table height.
- 1" apron; 1.5" square tube legs; 1" top
- Ships Knocked Down.

OPTIONS

- For Seam Connectors see the end of this section.
- For applicable Power & Data modules and cable management, please see Table Accessories Price List.
- Low profile 1.5"D locking casters.

HOW TO ORDER

1. Select Model
2. Select Base
3. Select Edge Style
4. Select Options
5. Select Top Finish
6. Select Edge Finish
7. Select Base Finish

Example: 3642RE - VST1 - 2MM -





VARSITY TABLES ACCESSORIES





| MODEL | | | |
|---|-------------|--------------|---|
| | <i>Code</i> | <i>Price</i> | |
| <p>SEAM CONNECTOR Seam Connectors join and level tops. Includes 2 connectors, 4 thumb screws, 4 counter sunk threaded metal inserts. Standard in Black. To be used on Varsity tables only.</p> | VSC | 87 |  |

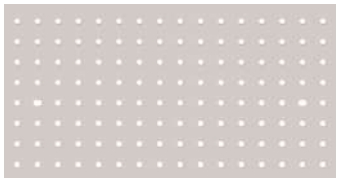
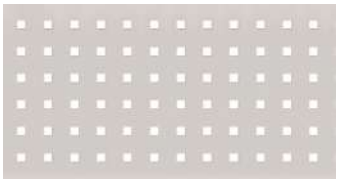

TABLE ACCESSORIES MODESTY PANELS

| SIZE | MODEL | DESCRIPTION | LIST | |
|-------------|--------------|---|------|---|
| For 42L Top | PMP-SR42 | SMALL ROUND (.266) PERFORATIONS Available in any Spectone color. Modesty Panels are 3" shorter than table and are 10" in height. Specify Modesty Panel to be fixed (add suffix F) or hinged (add suffix H). | 272 |  |
| For 48L Top | PMP-SR48 | | 272 | |
| For 54L Top | PMP-SR54 | | 272 | |
| For 60L Top | PMP-SR60 | | 272 | |
| For 66L Top | PMP-SR66 | | 272 | |
| For 72L Top | PMP-SR72 | | 272 | |
| For 42L Top | PMP-SS42 | SMALL SQUARE (.255) PERFORATIONS Available in any Spectone color. Modesty Panels are 3" shorter than table and are 10" in height. Specify Modesty Panel to be fixed (add suffix F) or hinged (add suffix H). | 272 |  |
| For 48L Top | PMP-SS48 | | 272 | |
| For 54L Top | PMP-SS54 | | 272 | |
| For 60L Top | PMP-SS60 | | 272 | |
| For 66L Top | PMP-SS66 | | 272 | |
| For 72L Top | PMP-SS72 | | 272 | |
| For 42L Top | PMP-BACKER42 | LARGE SQUARE (1.0) PERFORATIONS WITH ACRYLIC BACKER Available in any Spectone color. Modesty Panels are 3" shorter than table and are 10" in height. Acrylic backer available in semi-opaque Nickel. Specify Modesty Panel to be fixed (add suffix F) or hinged (add suffix H). | 631 |  |
| For 48L Top | PMP-BACKER48 | | 631 | |
| For 54L Top | PMP-BACKER54 | | 631 | |
| For 60L Top | PMP-BACKER60 | | 631 | |
| For 66L Top | PMP-BACKER66 | | 631 | |
| For 72L Top | PMP-BACKER72 | | 631 | |
| For 42L Top | PMP-DD42 | DASH & DOT PERFORATIONS Available in any Spectone color. Modesty Panels are 3" shorter than table and are 10" in height. Specify Modesty Panel to be fixed (add suffix F) or hinged (add suffix H). | 282 |  |
| For 48L Top | PMP-DD48 | | 282 | |
| For 54L Top | PMP-DD54 | | 282 | |
| For 60L Top | PMP-DD60 | | 337 | |
| For 66L Top | PMP-DD66 | | 337 | |
| For 72L Top | PMP-DD72 | | 394 | |
| For 42L Top | PMP-RESIN42 | ACRYLIC MODESTY PANEL Modesty Panels are 3" shorter than table and are 10" in height. Acrylic modesty panel is available in semi-opaque Nickel. Specify Modesty Panel to be fixed (add suffix F) or hinged (add suffix H). | 353 |  |
| For 48L Top | PMP-RESIN48 | | 353 | |
| For 54L Top | PMP-RESIN54 | | 353 | |
| For 60L Top | PMP-RESIN60 | | 353 | |
| For 66L Top | PMP-RESIN66 | | 353 | |
| For 72L Top | PMP-RESIN72 | | 353 | |
| For 42L Top | MP42 | WOOD OR LAMINATE MODESTY PANEL Self edge veneer or laminate modesty panel. Modesty Panels are 3" shorter than table and are 10" in height. Available on fixed tables only (add suffix F). | 335 |  |
| For 48L Top | MP48 | | 335 | |
| For 54L Top | MP54 | | 335 | |
| For 60L Top | MP60 | | 335 | |
| For 66L Top | MP66 | | 335 | |
| For 72L Top | MP72 | | 335 | |

For Manhattan tables only: when specified on a table with vertical wire managers, modesty panel attaches to the leg. If table is ordered without vertical wire manager, modesty panel attaches to the underside of the top. Cannot be used on a flip top without vertical wire managers.



TABLE ACCESSORIES

POWER AND COMMUNICATION COMPATIBILITY MATRIX

| Tables | Power | Grommets | Interact G2 | Interact IV G2 | Interface G2 | Villa | Cove | Cove Mini | CPCMJ | Power access door with trough |
|--|-------|----------|-------------|----------------|--------------|-------|------|-----------|-------|-------------------------------|
| Acute | | • | • | • | • | • | • | | • | |
| Annex | | • | • | • | • | • | • | | • | |
| Ark | | • | • | • | • | • | • | | • | |
| Askew | | • | • | • | • | • | • | | • | |
| Boardgames | | • | • | • | • | • | • | | • | |
| Companion | | | | | | • | • | | • | |
| Conductor | | • | • | • | • | • | • | | • | |
| Cooper | | | | | | | | | | |
| Dani | | • | | | | • | • | | • | |
| Docker | | • | • | • | • | • | • | | • | |
| Drum/Cube/Oval | | • | | | | • | • | | • | |
| Drum Base | | • | • | • | • | • | • | | • | |
| EndZone | | • | | | | • | • | | | • |
| Factory | | • | • | • | • | • | • | | • | |
| Fitt | | • | • | • | • | • | • | | • | |
| Half Round | | • | • | • | • | • | • | | • | |
| Manhattan | | • | • | • | • | • | • | | • | |
| Midway | | | | | | • | • | | • | |
| Post Legs | | • | • | • | • | • | • | | • | |
| Sidekick | | | | | | | | | | |
| Tailgate | | | | | | | | | | • |
| Tailor Freestanding | | | | | | | | • | | |
| Trumpet, Disc, Square Metal, Rectangle Metal | | • | • | • | • | • | • | | • | |
| Tubular | | • | • | • | • | • | • | | • | |
| Varsity | | • | • | • | • | • | • | | • | |





TABLE ACCESSORIES

POWER AND COMMUNICATION

INTERACT G2

| MODEL | DESCRIPTION | LIST |
|--|---|--|
| <p>SPC-ACT-21-B-108 SPC-ACT-21-S-108 SPC-ACT-21-W-108</p> | <p>Interact G2 with Cord Interact G2, 2 power, Cord, Black Interact G2, 2 power, Cord, Silver Interact G2, 2 power, Cord, White Includes 1 Telecom Blank Plate, 2 Keystone Knockouts, 2 Cord Pass Throughs, 1 Convenience Outlet, 108" long cord.</p> | <p>386 386 386</p> |
| <p>SPC-ACT-21U-B-108 SPC-ACT-21U-S-108 SPC-ACT-21U-W-108</p> | <p>Interact G2 with USB, Cord Interact G2, 2 power, 2 2.1 amp USB, Cord, Black Interact G2, 2 power, 2 2.1 amp USB, Cord, Silver Interact G2, 2 power, 2 2.1 amp USB, Cord, White Includes 1 Telecom Blank Plate, 2 Keystone Knockouts, 2 Cord Pass Throughs, 1 Convenience Outlet, 108" long cord.</p> | <p>528 528 528</p> |
| <p>SPC-ACT-21-B-HW-108 SPC-ACT-21-S-HW-108 SPC-ACT-21-W-HW-108</p> | <p>Interact G2 with Hardwire Interact G2, 2 power, Hardwire, Black Interact G2, 2 power, Hardwire, Silver Interact G2, 2 power, Hardwire, White Includes 1 Telecom Blank Plate, 2 Keystone Knockouts, 2 Cord Pass Throughs, 1 Convenience Outlet, 108" hardwire.</p> | <p>430 430 430</p> |
| <p>SPC-ACT-21U-B-HW-108 SPC-ACT-21U-S-HW-108 SPC-ACT-21U-W-HW-108</p> | <p>Interact G2 with USB, Hardwire Interact G2, 2 power, 2 2.1 amp USB, Hardwire, Black Interact G2, 2 power, 2 2.1 amp USB, Hardwire, Silver Interact G2, 2 power, 2 2.1 amp USB, Hardwire, White Includes 1 Telecom Blank Plate, 2 Keystone Knockouts, 2 Cord Pass Throughs, 1 Convenience Outlet, 108" hardwire.</p> | <p>573 573 573</p> |



| MODEL | KEYSTONE FOR KNOCKOUTS | LIST |
|-------------------|--|------|
| RJ11-A | Siemon Cat 3 female/punch down, Black | 34 |
| RJ45-B | RJ45 Cat 6 Data Jack | 58 |
| HDMI-KEY-B | HDMI F/F Keystone Jack, Black | 61 |



TABLE ACCESSORIES

POWER AND COMMUNICATION

INTERACT IV G2

| MODEL | DESCRIPTION | LIST |
|--|---|-------------------|
| SPC-ACT-41-B-108 SPC-ACT-41-S-108 SPC-ACT-41-W-108 | Interact IV G2 with Cord Interact IV G2, 4 power, Cord, Black Interact IV G2, 4 power, Cord, Silver Interact IV G2, 4 power, Cord, White Includes 2 Keystone Knockouts, 2 Cord Pass Thoughts, 1 Convenience Outlet, 108” long cord. | 577 577 577 |
| SPC-ACT-41U-B-108 SPC-ACT-41U-S-108 SPC-ACT-41U-W-108 | Interact IV G2 with USB, Cord Interact IV G2, 4 power, 2 2.1 amp USB, Cord, Black Interact IV G2, 4 power, 2 2.1 amp USB, Cord, Silver Interact IV G2, 4 power, 2 2.1 amp USB, Cord, White Includes 2 Keystone Knockouts, 2 Cord Pass Thoughts, 1 Convenience Outlet, 108” long cord. | 720 720 720 |
| SPC-ACT-41-B-HW-108 SPC-ACT-41-S-HW-108 SPC-ACT-41-W-HW-108 | Interact IV G2 with Hardwire Interact IV G2, 4 power, Hardwire, Black Interact IV G2, 4 power, Hardwire, Silver Interact IV G2, 4 power, Hardwire, White Includes 2 Keystone Knockouts, 2 Cord Pass Thoughts, 1 Convenience Outlet, 108” hardwire. | 622 622 622 |
| SPC-ACT-41U-B-HW-108 SPC-ACT-41U-S-HW-108 SPC-ACT-41U-W-HW-108 | Interact IV G2 with USB, Hardwire Interact IV G2, 4 power, 2 2.1 amp USB, Hardwire, Black Interact IV G2, 4 power, 2 2.1 amp USB, Hardwire, Silver Interact IV G2, 4 power, 2 2.1 amp USB, Hardwire, White Includes 2 Keystone Knockouts, 2 Cord Pass Thoughts, 1 Convenience Outlet, 108” hardwire. | 764 764 764 |



| MODEL | KEYSTONE FOR KNOCKOUTS | LIST |
|------------|--|------|
| RJ11-A | Siemon Cat 3 female/punch down, Black | 34 |
| RJ45-B | RJ45 Cat 6 Data Jack | 58 |
| HDMI-KEY-B | HDMI F/F Keystone Jack, Black | 61 |



TABLE ACCESSORIES POWER AND COMMUNICATION INTERFACE G2

| MODEL | DESCRIPTION | LIST |
|---|---|---|
| <p>SPC-INT-41-B-108 SPC-INT-41-S-108 SPC-INT-41-W-108</p> | <p>Interface G2 with Cord Interface G2, 4 power, Cord, Black Interface G2, 4 power, Cord, Silver Interface G2, 4 power, Cord, White Includes 1 Telecom Blank Plate, 2 Telecom Plate Cutouts, 1 Convenience Outlet, 108" long cord.</p> | <p>959 959 959</p> |
| <p>SPC-INT-41U-B-108 SPC-INT-41U-S-108 SPC-INT-41U-W-108</p> | <p>Interface G2 with USB, Cord Interface G2, 4 power, 2 2.1 amp USB, Cord, Black Interface G2, 4 power, 2 2.1 amp USB, Cord, Silver Interface G2, 4 power, 2 2.1 amp USB, Cord, White Includes 1 Telecom Blank Plate, 2 Telecom Plate Cutouts, 1 Convenience Outlet, 108" long cord.</p> | <p>1093 1093 1093</p> |



TABLE ACCESSORIES

POWER AND COMMUNICATION

INTERACT G2 & INTERFACE G2 TELECOM ACCESSORIES

| MODEL | DESCRIPTION | LIST |
|-------------|---|------|
| A-B | Telecom Plate with 1 RJ45 Siemon Cat 6. Available in Black (BL) , Gray (GR) and White (WH) . | 75 |
| A-B-B | Telecom Plate with 2 RJ45 Siemon Cat 6. Available in Black (BL) , Gray (GR) and White (WH) . | 131 |
| A-B-B-B | Telecom Plate with 3 RJ45 Siemon Cat 6. Available in Black (BL) , Gray (GR) and White (WH) . | 186 |
| A-B-B-B-B | Telecom Plate with 4 RJ45 Siemon Cat 6. Available in Black (BL) , Gray (GR) and White (WH) . | 242 |
| A-102-102 | Telecom Plate with 2 USB Type A/A with 72" cord attached. Available in Black (BL) , Gray (GR) and White (WH) . | 131 |
| A-B-B-C45 | Telecom Plate with 2 RJ45 Cat 6 Connectors and HDMI Female/Female with 36" patch cord attached. Available in Black (BL) , Gray (GR) and White (WH) . | 261 |
| A-C45 | Telecom Plate with 1 HDMI Female/Female with 36" patch cord attached. Available in Black (BL) , Gray (GR) and White (WH) . | 150 |
| A-C45-C51 | Telecom Plate with 1 HDMI Female/Female with 36" patch cord attached and 15 Pin HD VGA Female/Female with 60" patch cord attached. Available in Black (BL) , Gray (GR) and White (WH) . | 245 |
| A-C45-C51-L | Telecom Plate with 1 HDMI Female/Female with 36" patch cord attached, Mini Stereo Inline, and 15 Pin HD VGA Female/Female with 60" patch cord attached. Available in Black (BL) , Gray (GR) and White (WH) . | 283 |

TABLE ACCESSORIES

POWER AND COMMUNICATION

CPCM AND CPCMJ PACKAGES

| MODEL | DESCRIPTION | LIST | |
|----------|---|------|--|
| CPCMPP1 | CPCM POWER PACKAGE 1 Includes CPCM, CSP Surge Supressed Power Bar with 10' cord, CSP Snap in Power Bar Holder and 5" PVC Wire Managers (set of 4). Does not include data communication jacks. Specify 3', 6' or 10' cord length for CPCM. | 371 | |
| | | | |
| CPCMJPP2 | CPCMJ POWER PACKAGE 2 Includes CPCMJ, CSP Surge Supressed Power Bar with 10' cord, CSP Snap in Power Bar Holder and 5" PVC Wire Managers (set of 4). Includes RJ45 Cat 6 or RJ11. Specify 1 of each or 2 of either. Specify 3', 6' or 10' cord length for CPCMJ. | 458 | |
| | | | |

STANDARD FEATURES

- 15 Amp
- UL and CSA Listed



TABLE ACCESSORIES

POWER AND COMMUNICATION

CPCM AND CPCMJ ACCESSORIES



| | MODEL | DESCRIPTION | LIST | |
|---|--------------------------------|--|-------------------|---|
| | CPCM-3 CPCM-6 CPCM-10 | SINGLE DUPLEX WITHOUT JACKS Molded plastic housing and "flip-drop" lid. Available with cord lengths of 3', 6' or 10'. | 210 210 210 |  |
| | CPCMJ-3 CPCMJ-6 CPCMJ-10 | SINGLE DUPLEX WITH JACKS Molded plastic housing and "flip-drop" lid. Includes RJ45 Cat 6 or RJ11. Specify 1 of each or 2 of either. Available with cord lengths of 3', 6' or 10'. | 295 295 295 |  |
|  | GSP | SURGE SUPPRESSED SIX OUTLET POWER BAR Fits snug in the wire management trough and is standard with 10' cord in matte black. Is UL and CSA approved and can meet regional requirements. | 58 |  |
| | CSPHOLDER | CSP HOLDER PVC snap in holder secures power bar beneath table top. | 45 |  |

TABLE ACCESSORIES

POWER AND COMMUNICATION

COVE

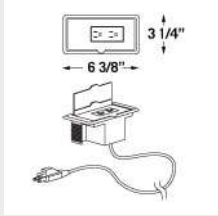
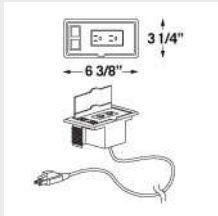
| | MODEL | DESCRIPTION | LIST | |
|--|---|--|------|--|
| | COVC2P2U-B COVC2P2U-S COVC2P2U-W | Cove, Clamp Mounted Cove, 2 power, 2 USB, Black Cove, 2 power, 2 USB, Silver Pearl Cove, 2 power, 2 USB, Gloss White Clamp mount method works well for desks, benches, tables and casegoods. Cord is 108" long. USB is for charging only. | 419 | |
| | | | 419 | |
| | | | 419 | |
| | | | | |
| | COVS2P2U-B COVS2P2U-S COVS2P2U-W | Cove, Screw Mounted Cove, 2 power, 2 USB, Black Cove, 2 power, 2 USB, Silver Pearl Cove, 2 power, 2 USB, Gloss White Screw mount method is best suited to installations where the back of the unit has limited or no access. Cord is 108" long. USB is for charging only. | 419 | |
| | | | 419 | |
| | | | 419 | |
| | | | | |
| | COVC2PC-B COVC2PC-S COVC2PC-W | Cove, Clamp Mounted, 1 Convenience Outlet Cove, 2 power, 1 Convenience Outlet, Black Cove, 2 power, 1 Convenience Outlet, Silver Pearl Cove, 2 power, 1 Convenience Outlet, Gloss White Clamp mount method works well for desks, benches, tables and casegoods. Cord is 108" long. | 303 | |
| | | | 303 | |
| | | | 303 | |
| | | | | |
| | COVC2P2U2C-B COVC2P2U2C-S COVC2P2U2C-W | Cove, Clamp Mounted, 2 Convenience Outlets Cove, 2 power, 2 USB, 2 Convenience Outlets, Black Cove, 2 power, 2 USB, 2 Convenience Outlets, Silver Pearl Cove, 2 power, 2 USB, 2 Convenience Outlets, Gloss White Clamp mount method works well for desks, benches, tables and casegoods. Cord is 108" long. USB is for charging only. | 535 | |
| | | | 535 | |
| | | | 535 | |
| | | | | |

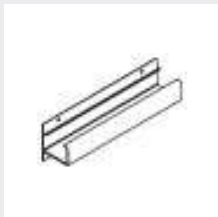



BACK TO CONTENTS

TABLE ACCESSORIES

POWER AND COMMUNICATION

VILLA™ SERIES - DAISYLINK™ SYSTEM - SINGLE KIT

| TABLE SIZE | MODEL | DESCRIPTION | LIST | |
|-------------|------------------|---|------|--|
| 36" L TABLE | VILLS2P2D-36B | 36" Villa, 2 power, 2 data ports, Black | 384 | |
| | VILLS2P2D-36S | 36" Villa, 2 power, 2 data ports, Silver | 384 | |
| | VILLS2P2D-36W | 36" Villa, 2 power, 2 data ports, White | 384 | |
| 42" L TABLE | VILLS2P2D-42B | 42" Villa, 2 power, 2 data ports, Black | 384 | |
| | VILLS2P2D-42S | 42" Villa, 2 power, 2 data ports, Silver | 384 | |
| | VILLS2P2D-42W | 42" Villa, 2 power, 2 data ports, White | 384 | |
| 48" L TABLE | VILLS2P2D-48B | 48" Villa, 2 power, 2 data ports, Black | 384 | |
| | VILLS2P2D-48S | 48" Villa, 2 power, 2 data ports, Silver | 384 | |
| | VILLS2P2D-48W | 48" Villa, 2 power, 2 data ports, White | 384 | |
| 60" L TABLE | VILLS2P2D-60B | 60" Villa, 2 power, 2 data ports, Black | 384 | |
| | VILLS2P2D-60S | 60" Villa, 2 power, 2 data ports, Silver | 384 | |
| | VILLS2P2D-60W | 60" Villa, 2 power, 2 data ports, White | 384 | |
| 72" L TABLE | VILLS2P2D-72B | 72" Villa, 2 power, 2 data ports, Black | 384 | |
| | VILLS2P2D-72S | 72" Villa, 2 power, 2 data ports, Silver | 384 | |
| | VILLS2P2D-72W | 72" Villa, 2 power, 2 data ports, White | 384 | |
| | | 2 Data Caps are included. RJ45 Data Jacks are not included. | | |
| 36" L TABLE | VILLS2P2U2RJ-36B | 36" Villa, 2 power, 2 USB 2.1 AMP ports, 2 RJ45 cat 6 data, Black | 638 | |
| | VILLS2P2U2RJ-36S | 36" Villa, 2 power, 2 USB 2.1 AMP ports, 2 RJ45 cat 6 data, Silver | 638 | |
| | VILLS2P2U2RJ-36W | 36" Villa, 2 power, 2 USB 2.1 AMP ports, 2 RJ45 cat 6 data, White | 638 | |
| 42" L TABLE | VILLS2P2U2RJ-42B | 42" Villa, 2 power, 2 USB 2.1 AMP ports, 2 RJ45 cat 6 data, Black | 638 | |
| | VILLS2P2U2RJ-42S | 42" Villa, 2 power, 2 USB 2.1 AMP ports, 2 RJ45 cat 6 data, Silver | 638 | |
| | VILLS2P2U2RJ-42W | 42" Villa, 2 power, 2 USB 2.1 AMP ports, 2 RJ45 cat 6 data, White | 638 | |
| 48" L TABLE | VILLS2P2U2RJ-48B | 48" Villa, 2 power, 2 USB 2.1 AMP ports, 2 RJ45 cat 6 data, Black | 638 | |
| | VILLS2P2U2RJ-48S | 48" Villa, 2 power, 2 USB 2.1 AMP ports, 2 RJ45 cat 6 data, Silver | 638 | |
| | VILLS2P2U2RJ-48W | 48" Villa, 2 power, 2 USB 2.1 AMP ports, 2 RJ45 cat 6 data, White | 638 | |
| 60" L TABLE | VILLS2P2U2RJ-60B | 60" Villa, 2 power, 2 USB 2.1 AMP ports, 2 RJ45 cat 6 data, Black | 638 | |
| | VILLS2P2U2RJ-60S | 60" Villa, 2 power, 2 USB 2.1 AMP ports, 2 RJ45 cat 6 data, Silver | 638 | |
| | VILLS2P2U2RJ-60W | 60" Villa, 2 power, 2 USB 2.1 AMP ports, 2 RJ45 cat 6 data, White | 638 | |
| 72" L TABLE | VILLS2P2U2RJ-72B | 72" Villa, 2 power, 2 USB 2.1 AMP ports, 2 RJ45 cat 6 data, Black | 638 | |
| | VILLS2P2U2RJ-72S | 72" Villa, 2 power, 2 USB 2.1 AMP ports, 2 RJ45 cat 6 data, Silver | 638 | |
| | VILLS2P2U2RJ-72W | 72" Villa, 2 power, 2 USB 2.1 AMP ports, 2 RJ45 cat 6 data, White | 638 | |
| | VRJ45 | Single RJ45 Cat6, Black | 58 | |
| | VHDMI-KEY | HDMI F/F Keystone Jack, Black | 61 | |

SINGLE KIT INCLUDES:

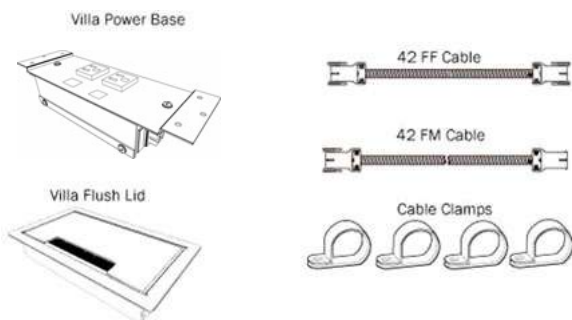



TABLE ACCESSORIES

POWER AND COMMUNICATION

VILLA™ SERIES - DAISYLINK™ SYSTEM - DOUBLE KIT

| TABLE SIZE | MODEL | DESCRIPTION | LIST | |
|-------------|------------------|---|------|--|
| 60" L TABLE | VILLD2P2D-60B | 60" Villa, 2 power, 2 data ports, Black | 724 | |
| | VILLD2P2D-60S | 60" Villa, 2 power, 2 data ports, Silver | 724 | |
| | VILLD2P2D-60W | 60" Villa, 2 power, 2 data ports, White | 724 | |
| 72" L TABLE | VILLD2P2D-72B | 72" Villa, 2 power, 2 data ports, Black | 724 | |
| | VILLD2P2D-72S | 72" Villa, 2 power, 2 data ports, Silver | 724 | |
| | VILLD2P2D-72W | 72" Villa, 2 power, 2 data ports, White | 724 | |
| 84" L TABLE | VILLD2P2D-84B | 84" Villa, 2 power, 2 data ports, Black | 724 | |
| | VILLD2P2D-84S | 84" Villa, 2 power, 2 data ports, Silver | 724 | |
| | VILLD2P2D-84W | 84" Villa, 2 power, 2 data ports, White | 724 | |
| 96" L TABLE | VILLD2P2D-96B | 96" Villa, 2 power, 2 data ports, Black | 724 | |
| | VILLD2P2D-96S | 96" Villa, 2 power, 2 data ports, Silver | 724 | |
| | VILLD2P2D-96W | 96" Villa, 2 power, 2 data ports, White | 724 | |
| | | 2 Data Caps are included. RJ45 Data Jacks are not included. | | |
| 60" L TABLE | VILLD2P2U2RJ-60B | 60" Villa, 2 power, 2 USB 2.1 AMP ports, 2 RJ45 cat 6 data, Black | 1229 | |
| | VILLD2P2U2RJ-60S | 60" Villa, 2 power, 2 USB 2.1 AMP ports, 2 RJ45 cat 6 data, Silver | 1229 | |
| | VILLD2P2U2RJ-60W | 60" Villa, 2 power, 2 USB 2.1 AMP ports, 2 RJ45 cat 6 data, White | 1229 | |
| 72" L TABLE | VILLD2P2U2RJ-72B | 72" Villa, 2 power, 2 USB 2.1 AMP ports, 2 RJ45 cat 6 data, Black | 1229 | |
| | VILLD2P2U2RJ-72S | 72" Villa, 2 power, 2 USB 2.1 AMP ports, 2 RJ45 cat 6 data, Silver | 1229 | |
| | VILLD2P2U2RJ-72W | 72" Villa, 2 power, 2 USB 2.1 AMP ports, 2 RJ45 cat 6 data, White | 1229 | |
| 84" L TABLE | VILLD2P2U2RJ-84B | 84" Villa, 2 power, 2 USB 2.1 AMP ports, 2 RJ45 cat 6 data, Black | 1229 | |
| | VILLD2P2U2RJ-84S | 84" Villa, 2 power, 2 USB 2.1 AMP ports, 2 RJ45 cat 6 data, Silver | 1229 | |
| | VILLD2P2U2RJ-84W | 84" Villa, 2 power, 2 USB 2.1 AMP ports, 2 RJ45 cat 6 data, White | 1229 | |
| 96" L TABLE | VILLD2P2U2RJ-96B | 96" Villa, 2 power, 2 USB 2.1 AMP ports, 2 RJ45 cat 6 data, Black | 1229 | |
| | VILLD2P2U2RJ-96S | 96" Villa, 2 power, 2 USB 2.1 AMP ports, 2 RJ45 cat 6 data, Silver | 1229 | |
| | VILLD2P2U2RJ-96W | 96" Villa, 2 power, 2 USB 2.1 AMP ports, 2 RJ45 cat 6 data, White | 1229 | |
| | VRJ45 | Single RJ45 Cat6, Black | 58 | |
| | VHDMI-KEY | HDMI F/F Keystone Jack, Black | 61 | |

Specify double kit when two Villas are in one single table

DOUBLE KIT INCLUDES

Villa Power Base



Villa Flush Lid

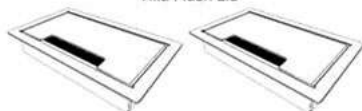



TABLE ACCESSORIES POWER AND COMMUNICATION VILLA™ SERIES - CORDED



| | MODEL | DESCRIPTION | LIST | |
|--|---------------|--|------|---|
| | VILLCDKO-36B | Corded Villa, 2 power, 2 data ports, 36" cord, Black | 295 |  |
| | VILLCDKO-36S | Corded Villa, 2 power, 2 data ports, 36" cord, Silver | 295 | |
| | VILLCDKO-72B | Corded Villa, 2 power, 2 data ports, 72" cord, Black | 295 | |
| | VILLCDKO-72S | Corded Villa, 2 power, 2 data ports, 72" cord, Silver | 295 | |
| | VILLCDKO-108B | Corded Villa, 2 power, 2 data ports, 108" cord, Black | 295 | |
| | VILLCDKO-108S | Corded Villa, 2 power, 2 data ports, 108" cord, Silver | 295 | |
| | VILLCUDKO-72B | Corded Villa, 2 power, 2 USB 2.1 AMP charging ports, 2 data ports, 72" cord, Black | 442 |  |
| | VILLCUDKO-72S | Corded Villa, 2 power, 2 USB 2.1 AMP charging ports, 2 data ports, 72" cord, Silver 2 Data Caps are included. RJ45 Data Jacks are not included. | 442 | |
| | VRJ45 | Single RJ45 Cat6, Black | 58 |  |
| | VHDMI-KEY | HDMI F/F Keystone Jack, Black | 61 | |



TABLE ACCESSORIES

POWER AND COMMUNICATION

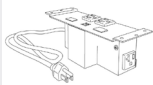
VILLA™ SERIES - OPTIONS

| | MODEL | DESCRIPTION | LIST | |
|---|----------------------|---|------|---|
| | VILLPOWERFEED | Multi-Circuit Hardwired Power Infeed UL Listed & CSA Certified | 213 |  |
| | VILLQDINSERT | Insert for floor box and wall outlet applications. Fits standard Decora® opening. UL Listed & CSA Certified | 94 |  |
|  | VILLFEEDPLUG | Single Circuit Power Infeed with 72" Molded Plug Required for non-sequenced power applications. UL Listed | 205 |  |
| | VILL42FFL-72 | Female/Female Interconnecting Cable UL Listed & CSA Certified | 134 |  |
| | VILLDAISYT | Daisy-T Power Manager | 140 |  |

TABLE ACCESSORIES WIRE MANAGEMENT & OTHER







| MODEL | DESCRIPTION | LIST | |
|---------------|---|------|---|
| CTRG | OVAL GROMMET 3" x 5" oval surface grommet. Specify centered or to the left or right on the desktop. Custom locations are available, please specify. | 38 |  |
| | | | |
| CTRS | ROUND GROMMET 2" round surface grommet. Specify centered or to the left or right on the desktop. Custom locations are available, please specify. Available in black, white or grey. | 24 |  |
| | | | |
| CWMT | PVC SNAP TO LEG WIRE MANAGER Snaps to table base column to conceal and manage unsightly wires. Standard in 13.5" lengths and matte black or Nickel finish. | 38 |  |
| | | | |
| VELCROWIREMGR | VELCRO WIRE MANAGER Affix to underside of table. | 12 |  |
| | | | |
| WIREMGR | UNDER TABLE WIRE MANAGER 24" PVC under table wire manager affix to underside of table. | 30 |  |
| | | | |
| 5PVCWIREMGR | 5" PVC WIRE MANAGER Set of 4, for under table wire management. | 54 |  |
| | | | |
| CMHA | CABLE MANAGER Cable management, spiral tube. Black. Plastic. 6" base diameter. Spiral 3-3/8" dia. Maximum height 84". | 284 |  |
| | | | |



TABLE ACCESSORIES WIRE MANAGEMENT & OTHER

| SIZE | MODEL | DESCRIPTION | LIST | | LBS |
|------------|------------|--|------|--|-----|
| 12" LENGTH | CESWN | PVC WIRE MANAGER Snaps neatly in place inside or under the Extruded Wire Management Trough. There are two inside channels and two channels under the trough. All channels run the entire length of the trough. PVC Wire Manager is standard in 12" lengths in matte black. | 15 |  | |
| | | | | | |
| | CSC | SEAM CONNECTOR Seam Connectors join and level tops. Includes 2 connectors, 4 thumb screws, 4 counter sunk threaded metal inserts. Can be used on any table except for Varsity. For Varsity table connector, please see Varsity table price list. | 87 |  | |
| | | | | | |
| | TABLE CART | TABLE CART Holds 4 to 6 tables of varying sizes. Comes standard with hard wheel swivel casters. Custom Carts are available. Ships KD. | 986 |  | 48 |
| | | | | | |

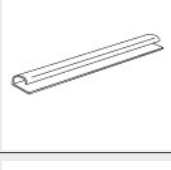
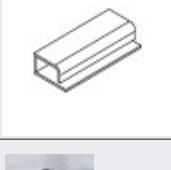
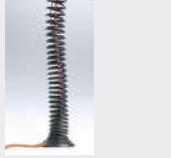
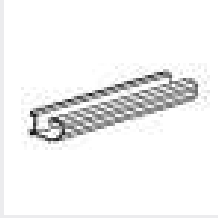



OVERBED TABLES & BEDSIDE CABINETS

BEDSIDE CABINETS & CASEGOODS



PRODUCT CODE

TBCABNR - A

Series

TBCAB : Standard
ATCABNR : Aluminum Trim

Configuration

A : 3 Drawer
BR : 1 Drawer with Right Hinged Door
BL : 1 Drawer with Left Hinged Door
C : 1 Drawer with Open Shelf
F : 2 Drawer with Floating Top
DHD : Heavy Duty with Recessed Shelf

OPTIONS

GALLERY RAIL



EXTENDED BASE



SPILL COLLECTOR



LOCKABLE CASTERS



ALUMINUM TRIM



HANDLES



Arc Door Handle



Straight Door Handle



Integrated Pull

FINISHES

LAMINATE



Select from 8 laminates

THERMOFOIL

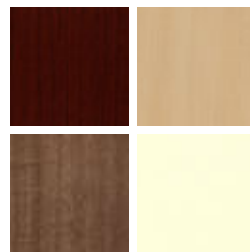

Select from one of our 7 standard Thermofoil finishes

ALUMINUM TRIM



Select from one of our 76 standard Spectone colors



BEDSIDE CABINETS & CASEGOODS STANDARD

Standard Features

- Choice of thermofoil or laminate finish on tops and fronts; melamine is standard on sides and backs
- 7 standard thermofoil and laminate finishes available, see below
- Steel drawer slides
- Arc and straight handle profiles are Brushed Nickel. Integrated pull also available
- Standard at 32" height
- Rear ventilation holes

Options

- Choice of 4 post legs or 4 locking casters (front 2 locking) at same price
- 3 drawer model not available with casters
- Spill Collector Edge for thermofoil tops only, add \$64 List
- Gallery Rail option add \$104 List (straight profile handle design)
- Plastic Drawer Insert add \$55 List
- Key Lock add \$60 List
- Extended Base Platform, add \$ 56 List
- For cabinets manufactured with NAUF Particle Board, call factory for pricing

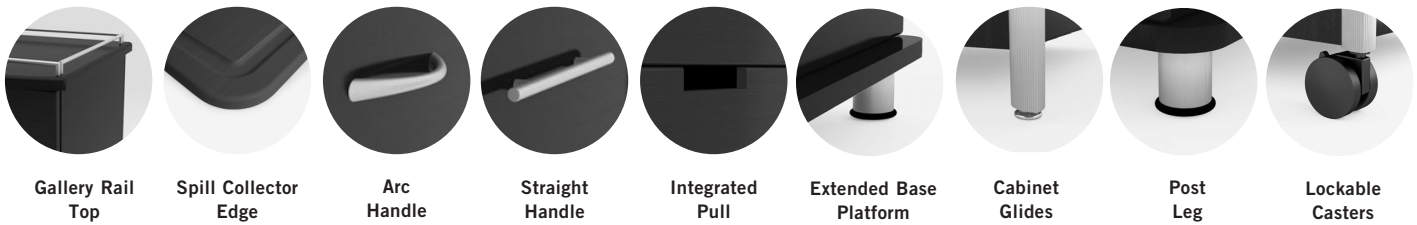

Bedside Cabinets

| | | Laminate Top 2mm Edge Melamine Front, Side and Back | Thermofoil Top and Front Thermofoil Edge Melamine Side and Back |
|--|-----------|---|---|
| 3 Drawer | TBCAB-A | 1042 | 1159 |
| 1 Drawer with hinged door on right and shelf | TBCAB-BR | 936 | 1050 |
| 1 Drawer with hinged door on left and shelf | TBCAB-BL | 936 | 1050 |
| 1 Drawer with open shelf | TBCAB-C | 896 | 964 |
| 2 Drawer with floating top | TBCAB-F | 1113 | 1296 |
| Heavy Duty Cabinet with recessed shelf | TBCAB-DHD | 1181 | N/A |

Dimensions (inches)

Width 20 Depth 21 Height 32



| | | | | | | |
|---|--|---|---|--|---|---|
| | | | | | | |
| Antique White Matches Wilsonart Antique White 1572-60 | Libretti Matches Wilsonart Cafelle 7933-07 | Wild Cherry Matches Wilsonart Wild Cherry 7054-60 | Brazilian Walnut Matches Wilsonart Figure Mahogany 7040A-60 | Almond Matches Wilsonart Natural Almond D30-60 | Hard Rock Maple Matches Arborite Hard Rock Maple L303 | Dark Walnut Matches Wilsonart Montana Walnut 7110T-60 |



BEDSIDE CABINETS & CASEGOODS

ALUMINUM SIDE TRIM

Standard Features

- Choice of thermofoil or laminate finish on tops and fronts; melamine is standard on sides and backs
- 7 standard thermofoil and laminate finishes available, see below
- Steel drawer slides
- Arc and straight handle profiles are brushed nickel Integrated pull also available
- Standard at 32" height
- Rear ventilation holes

Options

- Choice of 4 post legs or 4 locking casters (front 2 locking) at same price
- 3 drawer model not available with casters
- Spill Collector Edge, for thermofoil tops only, add \$64 List
- Gallery Rail option add \$104List (straight profile handle design)
- Plastic Drawer Insert add \$55 List
- Key Lock add \$60 List
- For cabinets manufactured with NAUF Particle Board, call factory for pricing



Gallery Rail Top



Spill Collector Edge



Arc Handle



Straight Handle

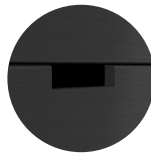

Integrated Pull

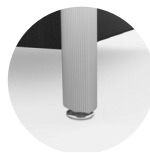

Cabinet Glides



Lockable Casters

Bedside Cabinets

| | | Laminate Top 2mm Edge Melamine Front, Side and Back | Thermofoil Top and Front Thermofoil Edge Melamine Side and Back |
|--|------------|---|---|
| 3 Drawer | ATCABNR-A | 1155 | 1282 |
| 1 Drawer with hinged door on right and shelf | ATCABNR-BR | 1039 | 1163 |
| 1 Drawer with hinged door on left and shelf | ATCABNR-BL | 1039 | 1163 |
| 1 Drawer with open shelf | ATCABNR-C | 1000 | 1073 |

Dimensions (inches)

Width 20 Depth 21 Height 32



ATCABNR-A



ATCABNR-BR



ATCABNR-BL



ATCABNR-C



Antique White
Matches Wilsonart
Antique White
1572-60



Libretti
Matches Wilsonart
Cafelle
7933-07



Wild Cherry
Matches Wilsonart
Wild Cherry
7054-60



Brazilian Walnut
Matches Wilsonart
Figure Mahogany
7040A-60



Almond
Matches Wilsonart
Natural Almond
D30-60



Hard Rock Maple
Matches Arborite
Hard Rock Maple
L303



Dark Walnut
Matches Wilsonart
Montana Walnut
7110T-60

BEDSIDE CABINETS & CASEGOODS DRESSERS

Standard Features

- Choice of thermofoil or laminate finish on tops and fronts; melamine is standard on sides and backs
- 7 standard thermofoil and laminate finishes available, see below
- Steel drawer slides
- Arc and straight handle profiles are brushed nickel
- Rear ventilation holes

Options

- For cabinets manufactured with NAUF Particle Board, call factory for pricing



Arc Handle



Straight Handle

Dressers

| | | |
|------------------|---|---|
| TBCAS-A | Laminate Top 2mm Edge Melamine Front, Side and Back | Thermofoil Top and Front Thermofoil Edge Melamine Side and Back |
| 3 Drawer Dresser | 1361 | 1507 |

| | | | |
|---------------------|------|--------|----|
| Dimensions (inches) | | | |
| Width | 32.5 | Depth | 21 |
| | | Height | 32 |



TBCAS-A 3 Drawer Dresser
143 Lbs
15 Cu Ft

| | | |
|------------------|---|---|
| TBCAS-B | Laminate Top 2mm Edge Melamine Front, Side and Back | Thermofoil Top and Front Thermofoil Edge Melamine Side and Back |
| 4 Drawer Dresser | 1595 | 1825 |

| | | | |
|---------------------|------|--------|------|
| Dimensions (inches) | | | |
| Width | 32.5 | Depth | 21 |
| | | Height | 41.5 |



TBCAS-B 4 Drawer Dresser
178 Lbs
19 Cu Ft



Antique White
Matches Wilsonart
Antique White
1572-60



Libretti
Matches Wilsonart
Cafelle
7933-07



Wild Cherry
Matches Wilsonart
Wild Cherry
7054-60



Brazilian Walnut
Matches Wilsonart
Figure Mahogany
7040A-60



Almond
Matches Wilsonart
Natural Almond
D30-60



Hard Rock Maple
Matches Arborite
Hard Rock Maple
L303



Dark Walnut
Matches Wilsonart
Montana Walnut
7110T-60



BEDSIDE CABINETS & CASEGOODS

TV UNIT

Standard Features

- Choice of thermofoil or laminate finish on tops and fronts; melamine is standard on sides and backs
- 7 standard thermofoil and laminate finishes available, see below
- Steel drawer slides
- Arc and straight handle profiles are brushed nickel
- Rear ventilation holes
- Post legs

Options

- For cabinets manufactured with NAUF Particle Board, call factory for pricing



Arc Handle



Straight Handle



TV Unit

| TBTV-A | Laminate Top 2mm Edge Melamine Front, Side and Back | Thermofoil Top and Front Thermofoil Edge Melamine Side and Back |
|--|---|---|
| TV Unit - Open shelf above, 3 drawers below | 2285 | 2812 |
| Dimensions (inches) | | |
| Width 32.5 Depth 25 | Height 68.5 | |



TBTV-A TV Unit
236 Lbs
42 Cu Ft



Antique White
Matches Wilsonart
Antique White
1572-60



Libretti
Matches Wilsonart
Cafelle
7933-07



Wild Cherry
Matches Wilsonart
Wild Cherry
7054-60



Brazilian Walnut
Matches Wilsonart
Figure Mahogany
7040A-60



Almond
Matches Wilsonart
Natural Almond
D30-60



Hard Rock Maple
Matches Arborite
Hard Rock Maple
L303



Dark Walnut
Matches Wilsonart
Montana Walnut
7110T-60

BEDSIDE CABINETS & CASEGOODS WARDROBES

Standard Features

- Choice of thermofoil or laminate finish on tops and fronts; melamine is standard on sides and backs
- 7 standard thermofoil and laminate finishes available, see below
- Steel drawer slides
- Arc and straight handle profiles are brushed nickel
- Rear ventilation holes
- Post legs

Options

- For cabinets manufactured with NAUF Particle Board, call factory for pricing



Arc Handle



Straight Handle

Wardrobes

| | | |
|------------------------------|---|---|
| TBWAR-A | Laminate Top 2mm Edge Melamine Front, Side and Back | Thermofoil Top and Front Thermofoil Edge Melamine Side and Back |
| Wardrobe - Full length doors | 2326 | 2953 |

Dimensions (inches)
Width 32.5 Depth 25 Height 68.5



TBWAR-A Wardrobe
249 Lbs
42 Cu Ft

| | | |
|------------------------------|---|---|
| TBWAR-B | Laminate Top 2mm Edge Melamine Front, Side and Back | Thermofoil Top and Front Thermofoil Edge Melamine Side and Back |
| Wardrobe - 2 Doors, 1 drawer | 2470 | 3280 |

Dimensions (inches)
Width 32.5 Depth 25 Height 68.5



TBWAR-B Wardrobe/Drawer
249 Lbs
42 Cu Ft



Antique White
Matches Wilsonart
Antique White
1572-60



Libretti
Matches Wilsonart
Cafelle
7933-07



Wild Cherry
Matches Wilsonart
Wild Cherry
7054-60



Brazilian Walnut
Matches Wilsonart
Figure Mahogany
7040A-60



Almond
Matches Wilsonart
Natural Almond
D30-60



Hard Rock Maple
Matches Arborite
Hard Rock Maple
L303



Dark Walnut
Matches Wilsonart
Montana Walnut
7110T-60

OVERBED TABLES



PRODUCT CODE

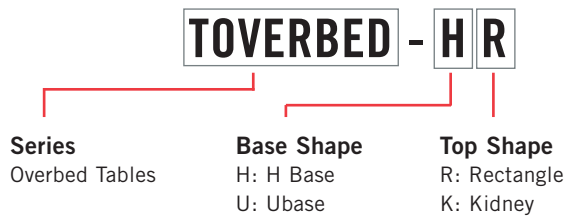

OPTIONS

BASES



H Base



U Base

TOPS



Kidney



Rectangle

SIDE TABLE



SPILL COLLECTOR



HIDEAWAY VANITY



WIRE BASKET



FINISHES

LAMINATE



Select from 15 standard laminates or choose any standard Wilsonart, Nevamar, Formica, Arborite and Pionite matte finish laminates at no upcharge

THERMOFOIL

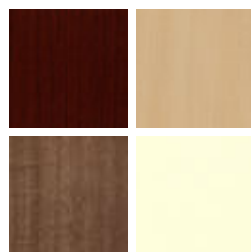

Select from one of our 7 standard Thermofoil finishes

BASE



Select from one of our 76 standard Spectone colors

EDGE



2MM



OVERBED TABLES

STANDARD FEATURES

- 3/4" laminate or thermoform tops are available in Rectangle or Kidney shapes
- 1.75" high H and U base designs
- Select laminate tops from 15 standard laminates or choose any standard Wilsonart, Nevamar, Formica, Arborite and Pionite matte finish laminates at no upcharge.
- 2mm Bio edge available in 38 solid colors
- 2mm PVC edge available in wood grain
- Thermofoil tops come standard with spill collector edge
- Thermofoil tops are available in a choice of 7 standard finishes (see below)
- Bases are standard in Nevada or Graphite Grey
- Standard with swivel non-locking casters
- Height range is 29"-43"
- Ships 2 per box

OPTIONS

- Hide-away Vanity, add \$ 225 List
- Storage Basket, add \$113 List



Storage Basket



Hide-away Vanity



U Base



H Base

Overbed Tables

| | | Laminate | Thermofoil |
|--|--------------|-------------|-------------|
| H Base with Rectangle Top - 17x32 | TOVERBED-HR | 1008 | 1038 |
| H Base with Kidney Top - 17x32 | TOVERBED-HK | 1008 | 1038 |
| H Base with Rectangle Top & Side Table - 17x40 | TOVERBED-HRF | | 1789 |
| H Base with Kidney Top & Side Table - 17x40 | TOVERBED-HKF | | 1789 |
| U Base with Rectangle Top - 17x32 | TOVERBED-UR | 1008 | 1038 |
| U Base with Kidney Top - 17x32 | TOVERBED-UK | 1008 | 1038 |
| U Base with Rectangle Top & Side Table - 17x40 | TOVERBED-URF | | 1789 |
| U Base with Kidney Top & Side Table - 17x40 | TOVERBED-UKF | | 1789 |



Antique White
Matches Wilsonart
Antique White
1572-60



Libretti
Matches Wilsonart
Cafelle
7933-07



Wild Cherry
Matches Wilsonart
Wild Cherry
7054-60



Brazilian Walnut
Matches Wilsonart
Figure Mahogany
7040A-60



Almond
Matches Wilsonart
Natural Almond
D30-60



Hard Rock Maple
Matches Arborite
Hard Rock Maple
L303



Dark Walnut
Matches Wilsonart
Montana Walnut
7110T-60



CREDENZAS, CARTS & LECTERNS

CREDENZAS, CARTS & LECTERNS



*Shown with an edge handle, and optional 1" x 1" Square Steel Tube Base.

PRODUCT CODE

CR 246029

Series
Credenza

Size
Width x Length x Height

OPTIONS

FOOT OPTIONS



2" Laminate or Veneer Kickplate Base



2" Brushed Aluminum Laminate Kickplate Base



1" x 1" Square Steel Tube Base



Casters on Hospitality Carts

HANDLES



Straight Handle
(Brushed Stainless Steel)

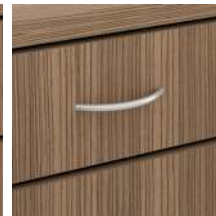

Arc Handle
(Brushed Stainless Steel)



Edge Handle
(Chrome)

GARBAGE PULL-OUT



FINISHES

LAMINATE



Select from 15 standard laminates or choose any standard Wilsonart, Nevamar, Formica, Arborite and Pionite matte finish laminates at no upcharge

VENEER

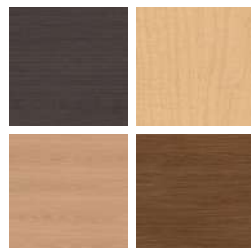

Select from one of our 9 standard wood stains or stain-to-match at no upcharge

EDGE



Check out our website for a complete list of edge profiles.

CORIAN TOP

See specfurniture.com for current Group A & B Corian Top finishes





1" x 1" SQ STEEL TUBE BASE

Select from 76 standard Spectone colors.





CREDENZAS - 29" HIGH

| | MODEL | SIZE | TOP SPECIFICATIONS | | | OPTIONS | LBS |
|---|----------------------|-----------------|--------------------|---------------------------------------|---|--------------|------------------|
| | | | <i>Code</i> | <i>For Laminate Top</i> | <i>For Veneer Top</i> | | |
| | | | PVF 2MM SE | HF HB HBV HBVR HB2 HKN | HF HB HBV HBVR HB2 HKN SE | GROUP A&B | |
| CREDENZA Two doors. One adjustable shelf.  <small>Product shown with optional 1" x 1" Square Steel Tube Base.</small> | CR243629-2D | 24D x 36W x 29H | 3155 | 3742 | 4366 | 1577 | 110 ¹ |
| CREDENZA Three doors. One adjustable shelf.  <small>Product shown with optional 1" x 1" Square Steel Tube Base.</small> | CR244829-3D | 24D x 48W x 29H | 3407 | 4052 | 4677 | 2090 | 140 ¹ |
| CREDENZA Two center drawers and two doors. One adjustable shelf.  <small>Product shown with optional 1" x 1" Square Steel Tube Base.</small> | CR244829-2F2D | 24D x 48W x 29H | 3888 | 4532 | 5157 | 2090 | 170 ¹ |

¹ For Corian Top add 20lbs for 2436, and 27lbs for 2448 credenza. All product images are shown with an edge handle, and optional 1" x 1" Square Steel Tube Base.

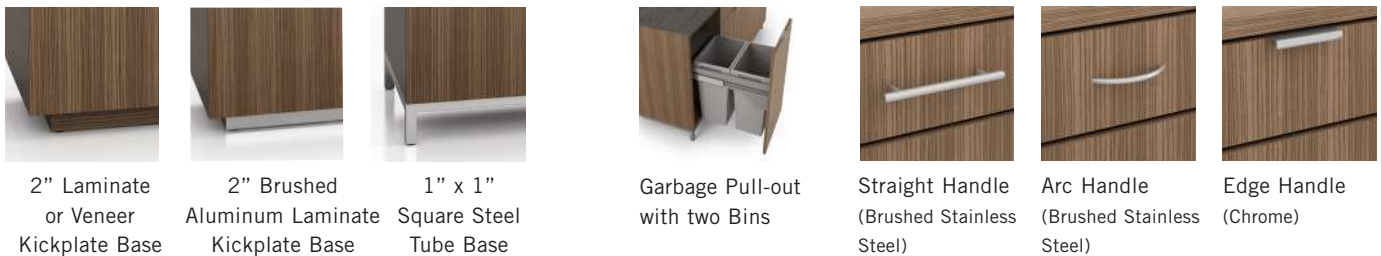

STANDARD FEATURES

- Select from 15 standard laminates or choose any standard Wilsonart, Nevamar, Formica, Arborite and Pionite matte finish laminates at no upcharge. For other laminate please contact the factory for pricing.
- 9 standard veneer and hardwood edge stains. Stain-to-match available at no upcharge.
- Standard credenza height 29".
- Touch latch doors are standard.
- 2" Laminate or Veneer Kickplate base is standard.
- Interior of closed laminate credenzas is finished in black melamine.

OPTIONS

- Specify straight, arc or edge handles at no upcharge.
- For Locks, add \$45 List per door.
- For standard size Ventilation cut-outs, add \$154 List. Contact Customer Service for size and location.
- For 1" x 1" Square Steel Tube Base, add \$308 List per credenza. Available in 76 Spectone colors.
- For Garbage Pull-Out, add \$1516 List each. Please note: when specified on a 20" deep credenza with Ventilation cut-outs, total credenza depth will be adjusted to 21".
- Available at 20" deep.



HOW TO ORDER

1. Select Model
2. Select Edge Style
3. Select Credenza Finish
4. Select Edge Finish
5. Select Base
6. Select Base Finish
7. Select Corian Top Finish, if applicable

Example: CR243629-2D - PVF
MODEL | EDGE



CREDENZAS - 29" HIGH

| | MODEL | SIZE | TOP SPECIFICATIONS | | | OPTIONS | LBS |
|---|----------------------|------------------------|--------------------|---------------------------------------|---|--------------|------------------|
| | | | | For Laminate Top | For Veneer Top | | |
| | Code | | PVF 2MM SE | HF HB HBV HBVR HB2 HKN | HF HB HBV HBVR HB2 HKN SE | GROUP A&B | |
| CREDENZA Four doors. One adjustable shelf.  Product shown with optional 1" x 1" Square Steel Tube Base. | CR246029-4D | 24D x 60W x 29H | 4258 | 5300 | 5923 | 2604 | 170 ¹ |
| | CR247229-4D | 24D x 72W x 29H | 5007 | 6548 | 7171 | 3117 | 200 ¹ |
| CREDENZA Two 6" drawers and four doors. One adjustable shelf.  Product shown with optional 1" x 1" Square Steel Tube Base. | CR246029-2B4D | 24D x 60W x 29H | 4739 | 5780 | 6403 | 2604 | 200 ¹ |
| | CR247229-2B4D | 24D x 72W x 29H | 5487 | 7030 | 7651 | 3117 | 235 ¹ |

¹ For Corian Top add 33lbs for 2460, and 39lbs for 2472 credenza.

All product images are shown with an edge handle, and optional 1" x 1" Square Steel Tube Base.



2" Laminate or Veneer Kickplate Base



2" Brushed Aluminum Laminate Kickplate Base



1" x 1" Square Steel Tube Base



Garbage Pull-out with two Bins

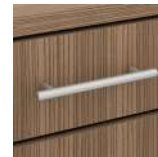

Straight Handle (Brushed Stainless Steel)



Arc Handle (Brushed Stainless Steel)



Edge Handle (Chrome)

STANDARD FEATURES

- Select from 15 standard laminates or choose any standard Wilsonart, Nevamar, Formica, Arborite and Pionite matte finish laminates at no upcharge. For other laminate please contact the factory for pricing.
- 9 standard veneer and hardwood edge stains. Stain-to-match available at no upcharge.
- Standard credenza height 29".
- Touch latch doors are standard.
- 2" Laminate or Veneer Kickplate base is standard.
- Interior of closed laminate credenzas is finished in black melamine.

OPTIONS

- Specify straight, arc or edge handles at no upcharge.
- For Locks, add \$45 List per door.
- For standard size Ventilation cut-outs, add \$154 List. Contact Customer Service for size and location.
- For 1" x 1" Square Steel Tube Base, add \$308 List per credenza. Available in 76 Spectone colors.
- For Garbage Pull-Out, add \$1516 List each. Please note: when specified on a 20" deep credenza with Ventilation cut-outs, total credenza depth will be adjusted to 21".
- Available at 20" deep.

HOW TO ORDER



1. Select Model
2. Select Edge Style
3. Select Credenza Finish
4. Select Edge Finish
5. Select Base
6. Select Base Finish
7. Select Corian Top Finish, if applicable

Example: CR246029-4D - PVF

MODEL | EDGE



CREDENZAS - 36" BUFFET HEIGHT

| | MODEL | SIZE | TOP SPECIFICATIONS | | | OPTIONS | LBS |
|---|-----------------------|-----------------|-------------------------|---------------------------------------|---|---------------------------------|------------------|
| | <i>Code</i> | | <i>For Laminate Top</i> | | <i>For Veneer Top</i> | <i>Corian Top GROUP A&B</i> | |
| | | | PVF 2MM SE | HF HB HBV HBVR HB2 HKN | HF HB HBV HBVR HB2 HKN SE | | |
| BUFFET HEIGHT CREDENZA Two doors. One adjustable shelf.  <small>Product shown with optional 1" x 1" Square Steel Tube Base.</small> | BUF243636-2D | 24D x 36W x 36H | 3261 | 3850 | 4472 | 1577 | 130 ¹ |
| BUFFET HEIGHT CREDENZA Three doors. One adjustable shelf.  <small>Product shown with optional 1" x 1" Square Steel Tube Base.</small> | BUF244836-3D | 24D x 48W x 36H | 3513 | 4160 | 4783 | 2090 | 160 ¹ |
| BUFFET HEIGHT CREDENZA Two center drawers and two doors. One adjustable shelf.  <small>Product shown with optional 1" x 1" Square Steel Tube Base.</small> | BUF244836-2F2D | 24D x 48W x 36H | 3994 | 4640 | 5263 | 2090 | 190 ¹ |

¹ For Corian Top add 20lbs for 2436, and 27lbs for 2448 credenza.

All product images are shown with an edge handle, and optional 1" x 1" Square Steel Tube Base.



2" Laminate or Veneer Kickplate Base



2" Brushed Aluminum Laminate Kickplate Base



1" x 1" Square Steel Tube Base



Garbage Pull-out with two Bins

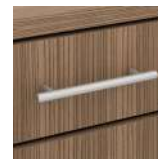

Straight Handle (Brushed Stainless Steel)



Arc Handle (Brushed Stainless Steel)



Edge Handle (Chrome)

STANDARD FEATURES

- Select from 15 standard laminates or choose any standard Wilsonart, Nevamar, Formica, Arborite and Pionite matte finish laminates at no upcharge. For other laminate please contact the factory for pricing.
- 9 standard veneer and hardwood edge stains. Stain-to-match available at no upcharge.
- Standard Credenza height is 36".
- Straight handle is standard.
- 2" Laminate or Veneer Kickplate base is standard.
- Interior of closed laminate credenzas is finished in black melamine.

OPTIONS

- Specify touch latch doors, arc or edge handles at no upcharge.
- For Locks, add \$45 List per door.
- For Ventilation cut-outs, add \$154 List. Contact Customer Service for size and location.
- For 1" x 1" Square Steel Tube Base, add \$308 List per credenza. Available in 76 Spectone colors.
- For Garbage Pull-Out, add \$1516 List each. Please note: when specified on a 20" deep credenza with Ventilation cut-outs, total credenza depth will be adjusted to 21".
- Available at 20" deep.



HOW TO ORDER

1. Select Model
2. Select Edge Style
3. Select Credenza Finish
4. Select Edge Finish
5. Select Base Finish
6. Select Corian Top Finish, if applicable

Example: BUF244836-2F2D

MODEL

CREDENZAS - 36" BUFFET HEIGHT

| | MODEL | SIZE | TOP SPECIFICATIONS | | | OPTIONS | LBS |
|---|-----------------------|-----------------|--------------------|---------------------------------------|---|---------|------------------|
| | | | Code | For Laminate Top | For Veneer Top | | |
| | | | PVF 2MM SE | HF HB HBV HBVR HB2 HKN | HF HB HBV HBVR HB2 HKN SE | | |
| BUFFET HEIGHT CREDENZA  Four doors. One adjustable shelf. Product shown with optional 1" x 1" Square Steel Tube Base. | BUF246036-4D | 24D x 60W x 36H | 4366 | 5408 | 6029 | 2604 | 195 ¹ |
| | BUF247236-4D | 24D x 72W x 36H | 5113 | 6656 | 7277 | 3117 | 230 ¹ |
| BUFFET HEIGHT CREDENZA  Two 6" drawers and four doors. One adjustable shelf. Product shown with optional 1" x 1" Square Steel Tube Base. | BUF246036-2B4D | 24D x 60W x 36H | 4846 | 5888 | 6509 | 2604 | 225 ¹ |
| | BUF247236-2B4D | 24D x 72W x 36H | 5594 | 7136 | 7758 | 3117 | 265 ¹ |

¹ For Corian Top add 33lbs for 2460, and 39lbs for 2472 credenza. All product images are shown with an edge handle, and optional 1" x 1" Square Steel Tube Base.



2" Laminate or Veneer Kickplate Base



2" Brushed Aluminum Laminate Kickplate Base



1" x 1" Square Steel Tube Base



Garbage Pull-out with two Bins

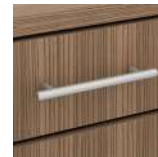

Straight Handle (Brushed Stainless Steel)



Arc Handle (Brushed Stainless Steel)



Edge Handle (Chrome)

STANDARD FEATURES

- Select from 15 standard laminates or choose any standard Wilsonart, Nevamar, Formica, Arborite and Pionite matte finish laminates at no upcharge. For other laminate please contact the factory for pricing.
- 9 standard veneer and hardwood edge stains. Stain-to-match available at no upcharge.
- Standard Credenza height is 36".
- Straight handle is standard.
- 2" Laminate or Veneer Kickplate base is standard.
- Interior of closed laminate credenzas is finished in black melamine.

OPTIONS

- Specify touch latch doors, arc or edge handles at no upcharge.
- For Locks, add \$45 List per door.
- For Ventilation cut-outs, add \$154 List. Contact Customer Service for size and location.
- For 1" x 1" Square Steel Tube Base, add \$308 List per credenza. Available in 76 Spectone colors.
- For Garbage Pull-Out, add \$1516 List each. Please note: when specified on a 20" deep credenza with Ventilation cut-outs, total credenza depth will be adjusted to 21".
- Available at 20" deep.

HOW TO ORDER





1. Select Model
2. Select Edge Style
3. Select Credenza Finish
4. Select Edge Finish
5. Select Base Finish
6. Select Corian Top Finish, if applicable

Example: BUF246036-4D

MODEL



HOSPITALITY CARTS

| | MODEL | SIZE | TOP SPECIFICATIONS | | LBS |
|--|-----------------------|-----------------|---------------------|-------------------|-----|
| | | | For Laminate Top SE | For Veneer Top SE | |
| HOSPITALITY CART  Two open fixed shelves. | HSP243036-2SH | 24D x 30W x 36H | 2614 | 3665 | 95 |
| | HSP243636-2SH | 24D x 36W x 36H | 2723 | 3774 | 108 |
| | HSP244236-2SH | 24D x 42W x 36H | 2832 | 3934 | 122 |
| | | | | | |
| HOSPITALITY CART  Two doors. One adjustable shelf. | HSP243036-2D | 24D x 30W x 36H | 2723 | 3774 | 112 |
| | HSP243636-2D | 24D x 36W x 36H | 2832 | 3883 | 128 |
| | HSP244236-2D | 24D x 42W x 36H | 2941 | 4044 | 145 |
| | | | | | |
|  HOSPITALITY CART  Two 6" drawers and two doors. One adjustable shelf. | HSP243036-2B2D | 24D x 30W x 36H | 3140 | 4191 | 133 |
| | HSP243636-2B2D | 24D x 36W x 36H | 3249 | 4300 | 152 |
| | HSP244236-2B2D | 24D x 42W x 36H | 3358 | 4462 | 171 |
| | | | | | |

All product images are shown with an edge handle.



Straight Handle
(Brushed Stainless Steel)



Arc Handle
(Brushed Stainless Steel)

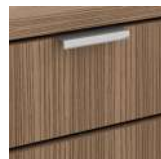

Edge Handle
(Chrome)



Locking Casters on Hospitality Carts

STANDARD FEATURES

- Select from 15 standard laminates or choose any standard Wilsonart, Nevamar, Formica, Arborite and Pionite matte finish laminates at no upcharge. For other laminate please contact the factory for pricing.
- 9 standard veneer and hardwood edge stains. Stain-to-match available at no upcharge.
- Standard hospitality cart height is 36".
- Straight handle is standard on doors and drawers. Side handle (to push or pull hospitality cart) is standard as square profile in Stainless Steel.
- Locking Casters.

OPTIONS

- Specify touch latch doors, arc or edge handles at no upcharge.
- For Locks, add \$45 List per door.
- For Ventilation cut-outs, add \$154 List. Contact Customer Service for size and location.
- Available at 20" deep.
- 2MM available on all outside edges.

HOW TO ORDER



1. Select Model
2. Select Edge Style
3. Select Cart Finish
4. Select Edge Finish
5. Select Corian Top Finish, if applicable

Example: HSP243636-2D

MODEL



LECTERNS

| | MODEL | SIZE | TOP SPECIFICATIONS | | LBS |
|--|--------------|-------------------|--------------------|---------------|-----|
| | <i>Code</i> | | <i>Laminate</i> | <i>Veneer</i> | |
| CONDUCTOR LECTERN  <p>One adjustable shelf and one keyboard tray.</p> <p>Specify metal finish for perforated metal.</p> | CCLEC | 24D x 24W x 50.5H | 3103 | 4009 | 110 |
| | | | | | |
| | | | | | |
| | | | | | |
| BOARDGAMES LECTERN  <p>One adjustable shelf.</p> <p>Specify aluminum or wood trim details.</p> | BGLEC | 24D x 24W x 50.5H | 2972 | 3804 | 100 |
| | | | | | |
| | | | | | |
| | | | | | |



STANDARD FEATURES

- Select from 15 standard laminates or choose any standard Wilsonart, Nevamar, Formica, Arborite and Pionite matte finish laminates at no upcharge. For other laminate please contact the factory for pricing.
- 9 standard veneer and hardwood edge stains. Stain-to-match available at no upcharge.
- Locking casters.
- Specify any Spectone color for metal components.



QUICKSHIP

10 DAY QUICKSHIP PROGRAM

Please note that during the pandemic, restrictions are in place for our QuickShip Program. Availability of parts, fabrics, shipping restrictions to many territories and reduced manufacturing capacity may inhibit our ability to meet your request. We will do our very best, however "Shipping within 10 business days-or it's free" is not applicable at this time.

10 Day Guarantee

Upon Acceptance and acknowledgement, 10 Day Quickship orders will ship from our factory (165 City View Drive Toronto, On, Canada) within 10 Business Days (excluding any statutory holidays) or the order will be deemed free. The original bill of lading, with your shipment from the Spec™ factory at 165 City View Drive Toronto, On, Canada, shall determine the shipping date.

Spec will endeavor to expedite your shipment upon departure from the factory.

Spec reserves the right to cancel or change the 10 Day Quickship program at any time, and may refuse to acknowledge a 10 Day Quickship order at our discretion.

Credit

All purchase orders are subject to credit approval. For our established dealers, terms are net 30 days from date of invoice. In some instances a deposit may be required to accompany an order. We will advise you if a deposit is required when we acknowledge your order.

Damage and Claim

All products are carefully examined before packaging for shipment. Ownership of your product passes to you upon pick-up by the carrier at our factory. Upon receipt of your order, check for any physical damage to the product (even if the carton is unmarked) that may have occurred during transit. Note any physical damage on all copies of the bill of lading and enter a freight claim with the carrier immediately. If you discover damage while unpacking, arrange for a carrier inspection immediately. Any damage, visible or concealed, must be reported to the carrier within 15 days from delivery. Our customer service people would be pleased to help you in any way during the process.

Cancellations, Returns and Changes

Orders are in process once acknowledged and may not be canceled without our consent. You may be responsible for work in process and administration costs including labor and raw materials. Merchandise may be returned only with our clear written authorization. Freight costs for return are your responsibility. Our product designs, processes, and materials are always under review ensuring the best quality and value to you. We will do our best to notify you as improvements occur.

Ordering Procedures

Please submit all 10 Day Quickship orders in writing via fax or e-mail direct to factory. Orders sent by fax do not require confirmation. Please use model numbers and finish codes with a brief description of the product(s) being ordered. Your order will be acknowledged in writing to you once clarified. We request your assistance in checking our acknowledgement's accuracy to your order to ensure discrepancies do not occur. It is your responsibility to let us know of any discrepancies within 24 hours of receiving the acknowledgement.

Quantity Limit

The 10 Day Shipping Program is available for a selection of tables and chairs to a maximum quantity of 20 pieces per order. If you need more than this quantity on your 10 day shipment, please contact Spec Customer service for approval. We will do our best to accommodate your needs. Spec reserves the right to limit product quantities for 10 Day shipments. The standard Spec shipping program applies to all 10 Day orders. Please refer to the online Shipping Program or contact Customer Service at 1.888.761.7732.

Spec reserves the right to cancel or change the 10 day program at any time and may refuse to acknowledge a 10 day order at our discretion.



10 DAY QUICKSHIP PROGRAM FINISHES

CHAIR FRAME / TABLE BASE / TABLE FLAT EDGE

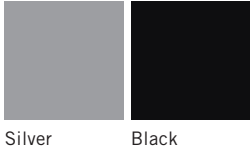

Silver Black

DURASPEC SEAT / PLASTIC BACK & BACK PANEL

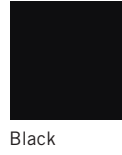

Black

CHAIR ARMS



Black

CHAIR WOOD BACK



Wild Cherry Fusion Maple

TABLE EDGE



PVC

FABRICS - MOMENTUM



Fuse Azurean Fuse Cress Fuse Ginger Fuse Iris Fuse Lunar Fuse Malted Fuse Pristine Fuse Walnut



Insight Bark Insight Blonde Insight Jade Insight Midnight Insight Pepper Insight Periwinkle Insight Summit Insight Wasabi



Beeline EPU Canvas Beeline EPU Eucalyptus Beeline EPU Fossil Beeline EPU Geyser Beeline EPU Portobello Beeline EPU Tidal

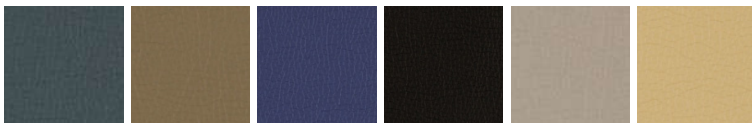

Canter EPU Ballard Canter EPU Earth Canter EPU Ink Canter EPU Onyx Canter EPU Quarry Canter EPU Toasty

TABLE TOP LAMINATE



Designer White Black Dove Grey Carbon Mesh Shadow Antique White Fusion Maple New Age Oak



Wild Cherry Walnut Heights Empire Mahogany River Cherry Cafelle Studio Teak Asian Night

Please note that during the pandemic, restrictions are in place for our QuickShip Program.

Availability of parts, fabrics, shipping restrictions to many territories and reduced manufacturing capacity may inhibit our ability to meet your request.

We will do our very best, however "Shipping within 10 business days-or it's free" is not applicable at this time.



10 DAY QUICKSHIP PROGRAM SNOWBALL 1

Standard Features

- Black polyurethane arms
- Black or silver frame finish
- See 10 Day Quickship price list or Spec website for the selection of quick ship textiles
- 10 Day Program quantity limit of 20 chairs per order

Options

- Snowball Dolly stacks 18" w Four-point Snowballs up to 10 high

For information on the 10 Day Program guarantee and terms and conditions, visit our website and go to 10 Day Quickship, Terms & Conditions tab.

Snowball 1

COM 1.0 yd
0.5 yd COM per single seat
0.5 yd COM per single back

| MODEL | COM | GR 1 | GR 2 |
|-------|-----|------|------|
| 1801 | 333 | 383 | 398 |
| 1811 | 333 | 383 | 398 |
| 1804 | 381 | 480 | 515 |



1801
With arms
20 lbs



1811
Without arms
19 lbs



1804
With arms
22 lbs

Snowball 1 – Dolly

| DESCRIPTION | MODEL | PRICE |
|-------------|-------|-------|
| Standard | 1899 | 367 |
| 22" Midsize | 1899M | 526 |

Dimensions (inches)

| | Standard | Midsize |
|--------|----------|---------|
| height | 36.5 | 36.5 |
| width | 21.0 | 23.0 |
| depth | 31.0 | 42.0 |



1899
Standard
18 lbs



1899M
Midsize
24 lbs



Please note that during the pandemic, restrictions are in place for our QuickShip Program.

Availability of parts, fabrics, shipping restrictions to many territories and reduced manufacturing capacity may inhibit our ability to meet your request.

We will do our very best, however "Shipping within 10 business days-or it's free" is not applicable at this time.



10 DAY QUICKSHIP PROGRAM SNOWBALL 2

Standard Features

- Black polyurethane arms
- Back with enhanced contours for superior comfort
- Black or silver frame finish
- See 10 Day Quickship price list or Spec website for the selection of quick ship textiles
- 10 Day Program quantity limit of 20 chairs per order

Options

- Snowball Dolly stacks regular width four-point Snowballs up to 10 high

For information on the 10 Day Program guarantee and terms and conditions, visit our website and go to 10 Day Quickship, Terms & Conditions tab.

Snowball 2

COM 1.0 yd
0.5 yd COM per single seat
0.5 yd COM per single back

| MODEL | COM | GR 1 | GR 2 |
|-------|-----|------|------|
| 1851 | 354 | 412 | 430 |
| 1861 | 354 | 412 | 430 |
| 1854 | 414 | 517 | 550 |



1851
With arms
20 lbs



1861
Without arms
19 lbs



1854
With arms
22 lbs

Snowball 2 – Dolly

| DESCRIPTION | MODEL | PRICE |
|-------------|-------|-------|
| Standard | 1899 | 367 |
| 22" Midsize | 1899M | 526 |

Dimensions (inches)

| | Standard | Midsize |
|--------|----------|---------|
| height | 36.5 | 36.5 |
| width | 21.0 | 23.0 |
| depth | 31.0 | 42.0 |



1899
Standard
18 lbs



1899M
Midsize
24 lbs



Please note that during the pandemic, restrictions are in place for our QuickShip Program.

Availability of parts, fabrics, shipping restrictions to many territories and reduced manufacturing capacity may inhibit our ability to meet your request.

We will do our very best, however "Shipping within 10 business days-or it's free" is not applicable at this time.



10 DAY QUICKSHIP PROGRAM SNOWBALL 3

Standard Features

- Black polyurethane arms
- Upholstered seat and wood back
- Back in Wild Cherry or Fusion Maple stains
- Back cut-out A
- Black or silver frame finish
- See 10 Day Quickship price list or Spec website for the selection of quick ship textiles
- 10 Day Program quantity limit of 20 chairs per order

Options

- Snowball Dolly stacks regular width four-point Snowballs up to 10 high



Wood Back Design "A"

For information on the 10 Day Program guarantee and terms and conditions, visit our website and go to 10 Day Quickship, Terms & Conditions tab.

Snowball 3

COM 0.5 yd
0.5 yd COM per single seat

| MODEL | COM | GR 1 | GR 2 |
|-------|-----|------|------|
| 1901 | 431 | 458 | 467 |
| 1911 | 431 | 458 | 467 |
| 1904 | 464 | 509 | 524 |



1901
With arms
18 lbs



1911
Without arms
17 lbs



1904
With arms
20 lbs

Snowball 3 – Dolly

| DESCRIPTION | MODEL | PRICE |
|-------------|-------|-------|
| Standard | 1899 | 367 |
| 22" Midsize | 1899M | 526 |

Dimensions (inches)

| | Standard | Midsize |
|--------|----------|---------|
| height | 36.5 | 36.5 |
| width | 21.0 | 23.0 |
| depth | 31.0 | 42.0 |



1899
Standard
18 lbs



1899M
Midsize
24 lbs



Please note that during the pandemic, restrictions are in place for our QuickShip Program.

Availability of parts, fabrics, shipping restrictions to many territories and reduced manufacturing capacity may inhibit our ability to meet your request.

We will do our very best, however "Shipping within 10 business days-or it's free" is not applicable at this time.



10 DAY QUICKSHIP PROGRAM URBAN

Standard Features

- 0.875" frame
- DuraSpec Poly seat and Plastic back
- DuraSpec Poly seat, Plastic back and Back panel available in Black only
- Black or silver frame finish
- 10 Day Program quantity limit of 20 chairs per order

For information on the 10 Day Program guarantee and terms and conditions, visit our website and go to 10 Day Quickship, Terms & Conditions tab.

Options

- Urban Dolly (Black finish only) stacks 18"w Four-point Urbans up to 10 high



Plastic Back & Plastic Back Panel

Urban, DuraSpec Poly Seat & Plastic Back - Four-point

| MODEL | Price |
|-------|-------|
| 1401 | 381 |
| 1411 | 381 |
| 1404 | 534 |

Dimensions (inches)

| | | | | | | | |
|--------|------|---------|------|-------------------|------|---------|------|
| seat H | 18.0 | seat W | 18.0 | arm H | 27.0 | total H | 32.5 |
| depth | 22.0 | total W | 24.0 | total W (no arms) | 20.1 | | |

Exceeds BIFMA Seating Durability Test to 500 lbs



1401
With arms
19 lbs



1411
Without arms
18 lbs



1404
With arms
22 lbs

Urban – Dolly

| DESCRIPTION | MODEL | PRICE |
|-------------|-------|-------|
| Standard | 1499 | 367 |
| Midsize 22" | 1499M | 526 |

Dimensions (inches)

| | Standard | Midsize |
|--------|----------|---------|
| height | 36.5 | 36.5 |
| width | 21.0 | 23.0 |
| depth | 31.0 | 42.0 |



1499
Standard
18 lbs

Please note that during the pandemic, restrictions are in place for our QuickShip Program.

Availability of parts, fabrics, shipping restrictions to many territories and reduced manufacturing capacity may inhibit our ability to meet your request.

We will do our very best, however "Shipping within 10 business days-or it's free" is not applicable at this time.



10 DAY QUICKSHIP PROGRAM MANHATTAN

BACK TO CONTENTS



| MODEL | BASES | | TOP SPECIFICATIONS | OPTIONS | MOBILITY | LBS |
|------------------|-----------------|-------------|---------------------------------|-------------------------------|------------------------------|-----|
| | <i>Code</i> | <i>Qty.</i> | <i>For Laminate Top PVF</i> | FLIP TOP <i>Add</i> | CASTERS <i>Add</i> | |
| <i>Round</i> | | | | | | |
| 36D | MNX | 1 | 824 | 154 | 96 | 55 |
| 42D | MNX | 1 | 1109 | 154 | 96 | 69 |
| <i>Square</i> | | | | | | |
| 36 X 36SQ | MNX | 1 | 842 | 154 | 96 | 55 |
| <i>Rectangle</i> | | | | | | |
| 24 X 48RE | MNT, MNC | 2 | 815 | 310 | 96 | 71 |
| 24 X 60RE | MNT, MNC | 2 | 876 | 310 | 96 | 79 |
| 30 X 60RE | MNT, MNC | 2 | 927 | 310 | 96 | 90 |
| 30 X 72RE | MNT, MNC | 2 | 1161 | 310 | 96 | 100 |



STANDARD FEATURES

- Select from 15 standard laminates.
- Standard with leveling glides.
- Bases available in Black or Silver only.
- Silver or Black PVC Flat Edge (PVF).
- Standard 29" table height.
- Locking Casters are not self-leveling.
- Base span increases with size of top.
- Quantity limit of 20 tables.

OPTIONS

- 2" grommet and oval grommet.
- Flip top.
- Casters.
- Seam connectors for joining and leveling tops.

HOW TO ORDER

1. Select Model
2. Select Base
3. Select Edge Style
4. Select Options
5. Select Top Finish
6. Select Edge Finish
7. Select Base Finish

Example: 36D - MNX - 2MM -
 MODEL | BASE | EDGE | OPTIONS



REVISIONS

BACK TO CONTENTS

| DATE | PAGE | DETAILS | DESCRIPTION |
|------|------|---------|-------------|
|------|------|---------|-------------|
