

## BOARDGAMES TABLES



### HOW TO ORDER

Boardgames is a series of tabletops and bases that allows complete flexibility when specifying boardrooms, meeting rooms, video conferencing and training areas.

For simplicity and ease of choice, tabletops and bases are priced separately. All bases are standard with a touch latch door for wire access and a cutout at the top for wire pass-through.



#### Step 1 - Select the tabletop

1. Choose the shape and size of the tabletop
  - see tabletop shapes
  - see tabletop dimensions and finishes
  - see tabletop sections and seating layouts
2. Choose laminate or veneer top finish
3. Choose an edge profile in hardwood, self edge, PVC or 2mm Edge

---

#### Step 2 - Select the base

1. Choose a base design
  - be sure to select the correct number of bases required for the table
2. Choose a base finish
  - laminate or veneer
3. Choose a base trim profile
  - aluminum extrusion or wood
4. Choose the finish of the base trim profile
  - if aluminum extrusion, choose any Spectone color
  - if wood, choose from 9 standard stains or stain-to-match at no upcharge

---

#### Step 3 - Select power and communication modules (if required)

1. Determine the number and type of modules required on the table
2. For each module select the appropriate power and data configuration.

For applicable Power & Data modules, please see Table Accessories Price List.

# BOARDGAMES TABLES



PLACING AN ORDER IS EASY

**PRODUCT CODE**

**4896 RE BG DR - L**

<p><b>Size</b> Width x Length</p>	<p><b>Top Shape</b> D : Round SQ : Square RE : Rectangle REA: Rectangle Arc RT : Racetrack BT : Boatshape BTA : Boatshape Arc</p>	<p><b>EL : Ellipse</b> <b>VC : Video</b> <b>Conference</b> <b>VCA : Video</b> <b>Conference Arc</b></p>	<p><b>Series</b> BG : Boardgame PL : Plinth</p>	<p><b>Base Shape</b> DR : Drum RE : Rectangle SQ : Square EL : Ellipse DDR : D-Drum HDR : Half Drum</p>	<p><b>Finish</b> L : Laminate V : Veneer</p>
---------------------------------------	---	---	---	---	--



**OPTIONS**

**BASE**



**TRIM DETAIL**



**FINISHES**

**LAMINATE**

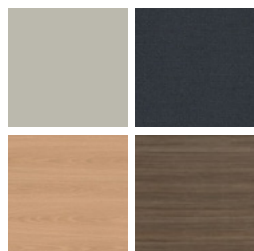

Select from 15 standard laminates or choose any standard Wilsonart, Nevamar, Formica, Arborite and Pionite matte finish laminates at no upcharge

**VENEER**



Select from one of our 9 standard wood stains or stain-to-match at no upcharge

**ALUMINUM BASE TRIM**

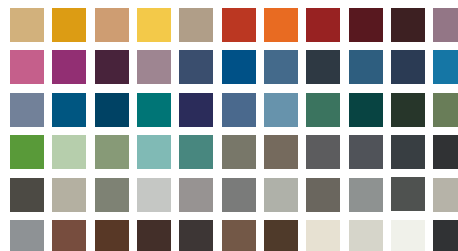

Select from one of our 76 standard Spectone colors

**EDGE**



Check out our website for a complete list of edge profiles.



# BOARDGAMES TABLES BOARDROOM

## TABLETOP SHAPES

On one piece tabletops, grain direction runs lengthwise.

On tabletops of two or more pieces, grain direction runs from side to side, as standard.

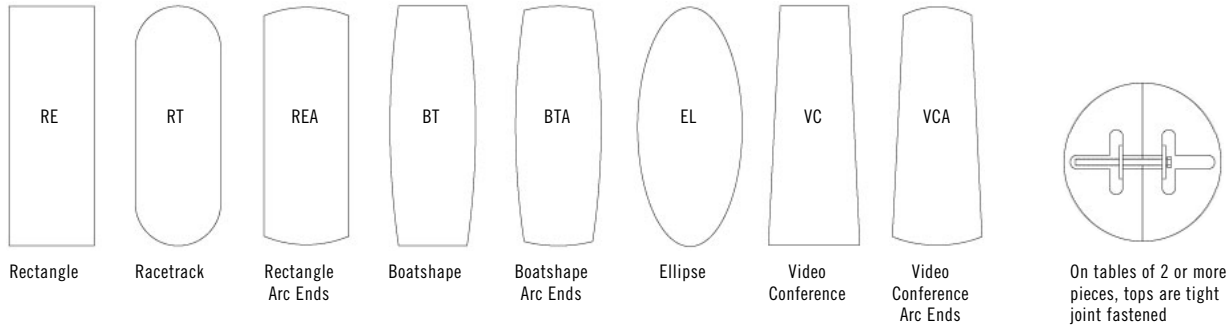

## EDGE PROFILES

Boardgames tabletops in veneer or laminate can be specified with any one of our standard hardwood edge profiles. Also available in self edge (SE), PVC flat (PVF), and 2mm Bio and PVC Edges (2MM).

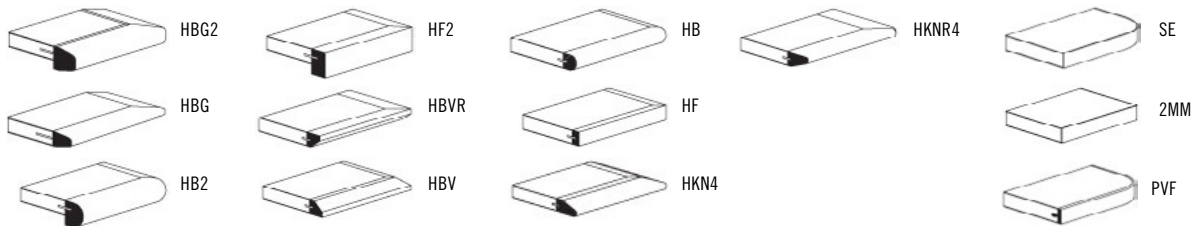

## BASE DESIGNS AND TRIM PROFILES

### Boardgames - Base Designs

Six different Boardgames bases are available, in laminate or veneer, standard at 22" width. For 30" width options, please contact Spec™ Customer Service. Each base features trim profiles in your choice of aluminum extrusion or wood. Aluminum extrusion is available in any Spectone color at no upcharge.

Wood trim on base stained in any of Spec's 9 standard stain colors or stain-to-match at no upcharge. The bases are standard with a touch latch removable door for wire access and a cutout at the top for wire pass-through.

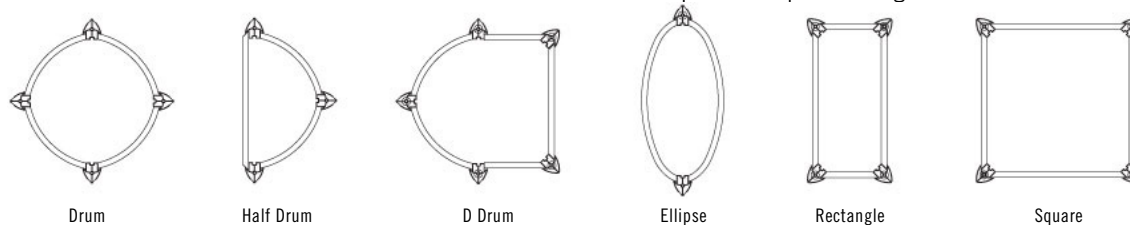

### Boardgames - Base Trim Profiles

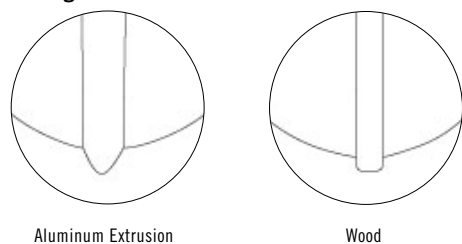



# BOARDGAMES TABLES

## BOARDROOM

### TABLETOP



MODEL	TABLETOPS		TOP AND EDGE SPECIFICATIONS						BASES	LBS
	Code	Number of Sections	For Laminate Top			For Veneer Top				
			SE PVF 2MM	HF HB	HBV HBVR HBG	HF2 HB2 HKN4 HKNR4 HBG2	HF HB HBV HBVR HBG	HF2 HB2 HKN4 HKNR4 HBG2	BGDR BGSQ PLDR PLSQ	
<i>Round</i>										
42	42D	1	543	1015	1114	1331	1353	1609	1	110
48	48D	1	563	1194	1303	1412	1797	2125	1	126
54	54D	1	799	1729	1900	2065	2256	2678	1	146
60	60D	1	837	1894	2076	2216	2776	3299	1	165



## BASES

MODEL	BASE SHAPES	FINISH	BASE PRICE	LBS
		<i>Aluminum or Wood Trim</i>		
BGDR-L	 BOARDGAME DRUM	Laminate	1206	75
BGDR-V	 BOARDGAME DRUM	Veneer	1351	75
BGSQ-L	 BOARDGAME SQUARE	Laminate	796	70
BGSQ-V	 BOARDGAME SQUARE	Veneer	940	70
PLDR-L	 PLINTH BASE DRUM	Laminate	1206	75
PLDR-V	 PLINTH BASE DRUM	Veneer	1351	75
PLSQ-L	 PLINTH BASE SQUARE	Laminate	796	70
PLSQ-V	 PLINTH BASE SQUARE	Veneer	940	70

\*Bases standard in 22" width. 30" width available, please contact factory for pricing.



BGDR



BGSQ



PLSQ



PLDR



# BOARDGAMES TABLES

## BOARDROOM

### TABLETOP



MODEL	TABLETOPS		TOP AND EDGE SPECIFICATIONS						BASES		LBS
	Code	Number of Sections	For Laminate Top			For Veneer Top			Number of Bases Required		
			SE PVF 2MM	HF HB	HBV HBVR HBG	HF2 HB2 HKN4 HKNR4 HBG2	HF HB HBV HBVR HBG	HF2 HB2 HKN4 HKNR4 HBG2	BGDR BGSQ PLDR PLSQ		
<i>Square</i>											
36 x 36	36SQ	1	328	510	559	731	736	900	1	98	
42 x 42	42SQ	1	556	819	900	982	1039	1261	1	112	
48 x 48	48SQ	1	681	912	998	1036	1345	1632	1	128	
54 x 54	54SQ	1	801	1311	1445	1599	1684	2057	1	146	
60 x 60	60SQ	1	826	1399	1539	1695	2075	2527	1	165	



## BASES

MODEL	BASE SHAPES	FINISH	BASE PRICE	LBS	
		<i>Aluminum or Wood Trim</i>			
BGDR-L		BOARDGAME DRUM	Laminate	1206	75
BGDR-V			Veneer	1351	75
BGSQ-L		BOARDGAME SQUARE	Laminate	796	70
BGSQ-V			Veneer	940	70
PLDR-L		PLINTH BASE DRUM	Laminate	1206	75
PLDR-V			Veneer	1351	75
PLSQ-L		PLINTH BASE SQUARE	Laminate	796	70
PLSQ-V			Veneer	940	70

\*Bases standard in 22" width. 30" width available, please contact factory for pricing.



BGDR



BGSQ



PLSQ



PLDR



# BOARDGAMES TABLES

## BOARDROOM

### TABLETOP



MODEL	TABLETOPS		TOP AND EDGE SPECIFICATIONS						BASES		LBS
	Code	Number of Sections	For Laminate Top			For Veneer Top			Number of Bases Required		
			SE PVF 2MM	HF HB	HBV HBVR HBG	HF2 HB2 HKN4 HKNR4 HBG2	HF HB HBV HBVR HBG	HF2 HB2 HKN4 HKNR4 HBG2	BGEL BGRE BGHDR*	BGDR BGSQ BGDDR*	
<i>Rectangle</i>											
48 x 96	4896RE	1	1158	1899	2101	2302	2607	3186	2	2	135
48 x 120	48120RE	2	1433	2392	2619	3109	3182	3859	3	2	168
48 x 144	48144RE	2	1756	3130	3431	3895	3785	4604	3	2	202
48 x 168	48168RE	2	2167	3551	3892	4544	4393	5344	3	3	236
48 x 192	48192RE	2	2432	4233	4649	5575	5258	6395	3	3	269
48 x 216	48216RE	2	2934	4718	5177	6162	5862	7143	3	3	303
60 x 120	60120RE	2	1828	3263	3575	4058	3944	4797	3	2	210
60 x 144	60144RE	2	2195	3915	4289	4870	4733	5753	3	2	252
60 x 168	60168RE	2	2563	4568	5003	5681	5520	6711	3	3	294
60 x 192	60192RE	2	3075	5480	6003	6818	6625	8053	3	3	336
60 x 216	60216RE	2	3459	6166	6756	7669	7452	9062	3	3	378

When specifying Half Drum (BGHDR) or D-Drum (BGDDR) bases where 3 bases are required, the middle base should be specified as a Rectangle base (BGRE).

## BASES

MODEL	BASE SHAPES	FINISH	BASE PRICE	LBS	
		<i>Aluminum or Wood Trim</i>			
BGDR-L		BOARDGAME DRUM	Laminate	1206	75
BGDR-V			Veneer	1351	75
BGRE-L		BOARDGAME RECTANGLE	Laminate	796	70
BGRE-V			Veneer	940	70
BGSQ-L		BOARDGAME SQUARE	Laminate	796	70
BGSQ-V			Veneer	940	70
BGEL-L		BOARDGAME ELLIPSE	Laminate	855	65
BGEL-V			Veneer	999	65
BGDDR-L		BOARDGAME D-DRUM	Laminate	1347	85
BGDDR-V			Veneer	1492	85
BGHDR-L		BOARDGAME HALF DRUM	Laminate	972	65
BGHDR-V			Veneer	1115	65
PLDR-L		PLINTH BASE DRUM	Laminate	1206	75
PLDR-V			Veneer	1351	75
PLSQ-L		PLINTH BASE SQUARE	Laminate	796	70
PLSQ-V			Veneer	940	70
PLRE-L		PLINTH BASE RECTANGLE	Laminate	796	70
PLRE-V			Veneer	940	70

\*Bases standard in 22" width. 30" width available, please contact factory for pricing.



For applicable Power & Data modules, please see Table Accessories Price List.



# BOARDGAMES TABLES

## BOARDROOM

### TABLETOP



MODEL	TABLETOPS		TOP AND EDGE SPECIFICATIONS						BASES		LBS
	Code	Number of Sections	For Laminate Top			For Veneer Top			Number of Bases Required		
			SE PVF 2MM	HF HB	HBV HBVR HBG	HF2 HB2 HKN4 HKNR4 HBG2	HF HB HBV HBVR HBG	HF2 HB2 HKN4 HKNR4 HBG2	BGEL BGRE BGHDR*	BGDR BGSQ BGDDR* PLDR PLSQ	
<i>Rectangle Arc Ends</i>											
48 x 96	4896REA	1	1173	2015	2218	2711	3057	3677	2	2	135
48 x 120	48120REA	2	1455	2786	3053	3732	3704	4428	3	2	168
48 x 144	48144REA	2	1782	3439	3768	4608	4413	5291	3	2	202
48 x 168	48168REA	2	2195	3998	4381	5313	5132	6150	3	3	236
48 x 192	48192REA	2	2347	4705	5156	6055	6297	7010	3	3	269
48 x 216	48216REA	2	2934	5274	5786	6900	7175	7869	3	3	303
60 x 120	60120REA	2	1820	3483	3815	4666	4629	5536	3	2	210
60 x 144	60144REA	2	2227	4299	4710	5763	5517	6613	3	2	252
60 x 168	60168REA	2	2744	4999	5477	6641	6415	7686	3	3	294
60 x 192	60192REA	2	3292	6000	6572	7969	8289	9225	3	3	336
60 x 216	60216REA	2	3705	6748	7393	8965	9326	10378	3	3	378

When specifying Half Drum (BGHDR) or D-Drum (BGDDR) bases where 3 bases are required, the middle base should be specified as a Rectangle base (BGRE).

## BASES

MODEL	BASE SHAPES	FINISH	BASE PRICE	LBS	
		<i>Aluminum or Wood Trim</i>			
BGDR-L		BOARDGAME DRUM	Laminate	1206	75
BGDR-V			Veneer	1351	75
BGRE-L		BOARDGAME RECTANGLE	Laminate	796	70
BGRE-V			Veneer	940	70
BGSQ-L		BOARDGAME SQUARE	Laminate	796	70
BGSQ-V			Veneer	940	70
BGEL-L		BOARDGAME ELLIPSE	Laminate	855	65
BGEL-V			Veneer	999	65
BGDDR-L		BOARDGAME D-DRUM	Laminate	1347	85
BGDDR-V			Veneer	1492	85
BGHDR-L		BOARDGAME HALF DRUM	Laminate	972	65
BGHDR-V			Veneer	1115	65
PLDR-L		PLINTH BASE DRUM	Laminate	1206	75
PLDR-V			Veneer	1351	75
PLSQ-L		PLINTH BASE SQUARE	Laminate	796	70
PLSQ-V			Veneer	940	70
PLRE-L		PLINTH BASE RECTANGLE	Laminate	796	70
PLRE-V			Veneer	940	70

\*Bases standard in 22" width. 30" width available, please contact factory for pricing.



For applicable Power & Data modules, please see Table Accessories Price List.



# BOARDGAMES TABLES

## BOARDROOM

### TABLETOP



MODEL	TABLETOPS		TOP AND EDGE SPECIFICATIONS						BASES		LBS
	Code	Number of Sections	For Laminate Top			For Veneer Top			Number of Bases Required		
			SE PVF 2MM	HF HB	HBV HBVR HBG	HF2 HB2 HKN4 HKNR4 HBG2	HF HB HBV HBVR HBG	HF2 HB2 HKN4 HKNR4 HBG2	BGEL BGRE BGHDR*	BGDR BGSQ BGDDR*	
<i>Racetrack</i>											
48 x 96	4896RT	1	1173	2015	2218	2711	3057	3677	2	2	135
48 x 120	48120RT	2	1455	2786	3053	3732	3704	4428	3	2	168
48 x 144	48144RT	2	1782	3439	3768	4608	4413	5291	3	2	202
48 x 168	48168RT	2	2195	3998	4381	5313	5132	6150	3	3	236
48 x 192	48192RT	2	2347	4705	5156	6055	6297	7010	3	3	269
48 x 216	48216RT	2	2934	5274	5786	6900	7175	7869	3	3	303
60 x 120	60120RT	2	1820	3483	3815	4666	4629	5536	3	2	210
60 x 144	60144RT	2	2227	4299	4710	5763	5517	6613	3	2	252
60 x 168	60168RT	2	2744	4999	5477	6641	6415	7686	3	3	294
60 x 192	60192RT	2	3292	6000	6572	7969	8289	9225	3	3	336
60 x 216	60216RT	2	3705	6748	7393	8965	9326	10378	3	3	378

When specifying Half Drum (BGHDR) or D-Drum (BGDDR) bases where 3 bases are required, the middle base should be specified as a Rectangle base (BGRE).

## BASES

MODEL	BASE SHAPES	FINISH	BASE PRICE	LBS	
		<i>Aluminum or Wood Trim</i>			
BGDR-L		BOARDGAME DRUM	Laminate	1206	75
BGDR-V			Veneer	1351	75
BGRE-L		BOARDGAME RECTANGLE	Laminate	796	70
BGRE-V			Veneer	940	70
BGSQ-L		BOARDGAME SQUARE	Laminate	796	70
BGSQ-V			Veneer	940	70
BGEL-L		BOARDGAME ELLIPSE	Laminate	855	65
BGEL-V			Veneer	999	65
BGDDR-L		BOARDGAME D-DRUM	Laminate	1347	85
BGDDR-V			Veneer	1492	85
BGHDR-L		BOARDGAME HALF DRUM	Laminate	972	65
BGHDR-V			Veneer	1115	65
PLDR-L		PLINTH BASE DRUM	Laminate	1206	75
PLDR-V			Veneer	1351	75
PLSQ-L		PLINTH BASE SQUARE	Laminate	796	70
PLSQ-V			Veneer	940	70
PLRE-L		PLINTH BASE RECTANGLE	Laminate	796	70
PLRE-V			Veneer	940	70

\*Bases standard in 22" width. 30" width available, please contact factory for pricing.



For applicable Power & Data modules, please see Table Accessories Price List.





# BOARDGAMES TABLES

## BOARDROOM

### TABLETOP



MODEL	TABLETOPS		TOP AND EDGE SPECIFICATIONS						BASES		LBS
	Code	Number of Sections	For Laminate Top			For Veneer Top			Number of Bases Required		
			SE PVF 2MM	HF HB	HBV HBVR HBG	HF2 HB2 HKN4 HKNR4 HBG2	HF HB HBV HBVR HBG	HF2 HB2 HKN4 HKNR4 HBG2	BGEL BGRE BGHDR*	BGDR BGSQ BGDDR*	
<i>Boatshape</i>											
48 x 96	4896BT	1	1173	2584	2848	3120	3503	3841	2	2	135
48 x 120	48120BT	2	1455	3413	3741	4085	4231	4620	3	2	168
48 x 144	48144BT	2	1782	4066	4457	4870	5391	5743	3	2	202
48 x 168	48168BT	2	2195	4693	5145	5622	5864	6414	3	3	236
48 x 192	48192BT	2	2347	5411	5933	6964	7243	8062	3	3	269
48 x 216	48216BT	2	2934	6063	6653	7934	8251	9049	3	3	303
60 x 120	60120BT	2	1820	4266	4677	5105	5291	5775	3	2	210
60 x 144	60144BT	2	2227	5085	5571	6087	6737	7181	3	2	252
60 x 168	60168BT	2	2744	5866	6431	7028	7331	8018	3	3	294
60 x 192	60192BT	2	3292	7039	7718	8433	8794	9619	3	3	336
60 x 216	60216BT	2	3705	7921	8683	9488	9895	10822	3	3	378

When specifying Half Drum (BGHDR) or D-Drum (BGDDR) bases where 3 bases are required, the middle base should be specified as a Rectangle base (BGRE).

## BASES

MODEL	BASE SHAPES	FINISH	BASE PRICE	LBS	
		<i>Aluminum or Wood Trim</i>			
BGDR-L		BOARDGAME DRUM	Laminate	1206	75
BGDR-V			Veneer	1351	75
BGRE-L		BOARDGAME RECTANGLE	Laminate	796	70
BGRE-V			Veneer	940	70
BGSQ-L		BOARDGAME SQUARE	Laminate	796	70
BGSQ-V			Veneer	940	70
BGEL-L		BOARDGAME ELLIPSE	Laminate	855	65
BGEL-V			Veneer	999	65
BGDDR-L		BOARDGAME D-DRUM	Laminate	1347	85
BGDDR-V			Veneer	1492	85
BGHDR-L		BOARDGAME HALF DRUM	Laminate	972	65
BGHDR-V			Veneer	1115	65
PLDR-L		PLINTH BASE DRUM	Laminate	1206	75
PLDR-V			Veneer	1351	75
PLSQ-L		PLINTH BASE SQUARE	Laminate	796	70
PLSQ-V			Veneer	940	70
PLRE-L		PLINTH BASE RECTANGLE	Laminate	796	70
PLRE-V			Veneer	940	70

\*Bases standard in 22" width. 30" width available, please contact factory for pricing.



For applicable Power & Data modules, please see Table Accessories Price List.



# BOARDGAMES TABLES

## BOARDROOM

### TABLETOP



MODEL	TABLETOPS		TOP AND EDGE SPECIFICATIONS						BASES		LBS
	Code	Number of Sections	For Laminate Top			For Veneer Top			Number of Bases Required		
			SE PVF 2MM	HF HB	HBV HBVR HBG	HF2 HB2 HKN4 HKNR4 HBG2	HF HB HBV HBVR HBG	HF2 HB2 HKN4 HKNR4 HBG2	BGEL BGRE BGHDR*	BGDR BGSQ BGDDR*	
									PLRE	PLDR PLSQ	
<i>Boatshape Arc Ends</i>											
48 x 96	4896BTA	1	1318	3039	3301	3573	3954	4294	2	2	135
48 x 120	48120BTA	2	1598	3867	4193	4536	4682	5072	3	2	168
48 x 144	48144BTA	2	1925	4519	4909	5320	5841	6196	3	2	202
48 x 168	48168BTA	2	2340	5145	5596	6074	6316	6867	3	3	236
48 x 192	48192BTA	2	2581	5950	6524	7660	7967	8868	3	3	269
48 x 216	48216BTA	2	3227	6672	7319	8728	9077	9953	3	3	303
60 x 120	60120BTA	2	1999	4833	5240	5671	5852	6338	3	2	210
60 x 144	60144BTA	2	2406	5649	6137	6653	7301	7744	3	2	252
60 x 168	60168BTA	2	2925	6431	6996	7591	7894	8582	3	3	294
60 x 192	60192BTA	2	3508	7718	8396	9107	9473	10298	3	3	336
60 x 216	60216BTA	2	3948	8683	9445	10249	10657	11586	3	3	378

When specifying Half Drum (BGHDR) or D-Drum (BGDDR) bases where 3 bases are required, the middle base should be specified as a Rectangle base (BGRE).

## BASES

MODEL	BASE SHAPES	FINISH	BASE PRICE	LBS	
		<i>Aluminum or Wood Trim</i>			
BGDR-L		BOARDGAME DRUM	Laminate	1206	75
BGDR-V			Veneer	1351	75
BGRE-L		BOARDGAME RECTANGLE	Laminate	796	70
BGRE-V			Veneer	940	70
BGSQ-L		BOARDGAME SQUARE	Laminate	796	70
BGSQ-V			Veneer	940	70
BGEL-L		BOARDGAME ELLIPSE	Laminate	855	65
BGEL-V			Veneer	999	65
BGDDR-L		BOARDGAME D-DRUM	Laminate	1347	85
BGDDR-V			Veneer	1492	85
BGHDR-L		BOARDGAME HALF DRUM	Laminate	972	65
BGHDR-V			Veneer	1115	65
PLDR-L		PLINTH BASE DRUM	Laminate	1206	75
PLDR-V			Veneer	1351	75
PLSQ-L		PLINTH BASE SQUARE	Laminate	796	70
PLSQ-V			Veneer	940	70
PLRE-L		PLINTH BASE RECTANGLE	Laminate	796	70
PLRE-V			Veneer	940	70

\*Bases standard in 22" width. 30" width available, please contact factory for pricing.



For applicable Power & Data modules, please see Table Accessories Price List.



# BOARDGAMES TABLES

## BOARDROOM

### TABLETOP



MODEL	TABLETOPS		TOP AND EDGE SPECIFICATIONS						BASES		LBS
	Code	Number of Sections	For Laminate Top			For Veneer Top			Number of Bases Required		
			SE PVF 2MM	HF HB	HBV HBVR HBG	HF2 HB2 HKN4 HKNR4 HBG2	HF HB HBV HBVR HBG	HF2 HB2 HKN4 HKNR4 HBG2	BGEL BGRE BGHDR*	BGDR BGSQ BGDDR* PLDR PLSQ	
<i>Ellipse</i>											
48 x 96	4896EL	1	1410	3102	3419	3745	4203	4609	2	2	135
48 x 120	48120EL	2	1746	4096	4489	4900	5079	5542	3	2	168
48 x 144	48144EL	2	2137	4881	5348	5844	6467	6894	3	2	202
48 x 168	48168EL	2	2635	5631	6174	6744	7015	7698	3	3	236
48 x 192	48192EL	2	2840	6547	7177	8424	8763	9754	3	3	269
48 x 216	48216EL	2	3550	7339	8049	9602	9986	10948	3	3	303
60 x 120	60120EL	2	2300	5560	6026	6521	6731	7288	3	2	210
60 x 144	60144EL	2	2767	6496	7057	7651	8396	8905	3	2	252
60 x 168	60168EL	2	3363	7395	8044	8729	9078	9869	3	3	294
60 x 192	60192EL	2	4036	8874	9655	10475	10893	11844	3	3	336
60 x 216	60216EL	2	4540	9985	10862	11785	12255	13325	3	3	378

When specifying Half Drum (BGHDR) or D-Drum (BGDDR) bases where 3 bases are required, the middle base should be specified as a Rectangle base (BGRE).

## BASES

MODEL	BASE SHAPES	FINISH	BASE PRICE	LBS	
		<i>Aluminum or Wood Trim</i>			
BGDR-L		BOARDGAME DRUM	Laminate	1206	75
BGDR-V			Veneer	1351	75
BGRE-L		BOARDGAME RECTANGLE	Laminate	796	70
BGRE-V			Veneer	940	70
BGSQ-L		BOARDGAME SQUARE	Laminate	796	70
BGSQ-V			Veneer	940	70
BGEL-L		BOARDGAME ELLIPSE	Laminate	855	65
BGEL-V			Veneer	999	65
BGDDR-L		BOARDGAME D-DRUM	Laminate	1347	85
BGDDR-V			Veneer	1492	85
BGHDR-L		BOARDGAME HALF DRUM	Laminate	972	65
BGHDR-V			Veneer	1115	65
PLDR-L		PLINTH BASE DRUM	Laminate	1206	75
PLDR-V			Veneer	1351	75
PLSQ-L		PLINTH BASE SQUARE	Laminate	796	70
PLSQ-V			Veneer	940	70
PLRE-L		PLINTH BASE RECTANGLE	Laminate	796	70
PLRE-V			Veneer	940	70

\*Bases standard in 22" width. 30" width available, please contact factory for pricing.



For applicable Power & Data modules, please see Table Accessories Price List.



# BOARDGAMES TABLES

## BOARDROOM

### TABLETOP



MODEL	TABLETOPS		TOP AND EDGE SPECIFICATIONS						BASES		LBS
	Code	Number of Sections	For Laminate Top			For Veneer Top			Number of Bases Required		
			SE PVF 2MM	HF HB	HBV HBVR HBG	HF2 HB2 HKN4 HKNR4 HBG2	HF HB HBV HBVR HBG	HF2 HB2 HKN4 HKNR4 HBG2	BGEL BGRE BGHDR*	BGDR BGSQ BGDDR*	
<i>Video Conference</i>											
48 x 96	4896VC	1	1173	2584	2848	3120	3503	3841	2	2	135
48 x 120	48120VC	2	1455	3413	3741	4085	4231	4620	3	2	168
48 x 144	48144VC	2	1782	4066	4457	4870	5391	5743	3	2	202
48 x 168	48168VC	2	2195	4693	5145	5622	5846	6414	3	3	236
48 x 192	48192VC	2	2347	5411	5933	6964	7243	8062	3	3	269
48 x 216	48216VC	2	2934	6063	6653	7934	8251	9049	3	3	303
60 x 120	60120VC	2	1820	4266	4677	5105	5291	5775	3	2	210
60 x 144	60144VC	2	2227	5085	5571	6087	6737	7181	3	2	252
60 x 168	60168VC	2	2744	5866	6431	7028	7331	8018	3	3	294
60 x 192	60192VC	2	3292	7039	7718	8433	8794	9619	3	3	336
60 x 216	60216VC	2	3705	7921	8683	9488	9895	10822	3	3	378

When specifying Half Drum (BGHDR) or D-Drum (BGDDR) bases where 3 bases are required, the middle base should be specified as a Rectangle base (BGRE).

## BASES

MODEL	BASE SHAPES	FINISH	BASE PRICE	LBS	
		<i>Aluminum or Wood Trim</i>			
BGDR-L		BOARDGAME DRUM	Laminate	1206	75
BGDR-V			Veneer	1351	75
BGRE-L		BOARDGAME RECTANGLE	Laminate	796	70
BGRE-V			Veneer	940	70
BGSQ-L		BOARDGAME SQUARE	Laminate	796	70
BGSQ-V			Veneer	940	70
BGEL-L		BOARDGAME ELLIPSE	Laminate	855	65
BGEL-V			Veneer	999	65
BGDDR-L		BOARDGAME D-DRUM	Laminate	1347	85
BGDDR-V			Veneer	1492	85
BGHDR-L		BOARDGAME HALF DRUM	Laminate	972	65
BGHDR-V			Veneer	1115	65
PLDR-L		PLINTH BASE DRUM	Laminate	1206	75
PLDR-V			Veneer	1351	75
PLSQ-L		PLINTH BASE SQUARE	Laminate	796	70
PLSQ-V			Veneer	940	70
PLRE-L		PLINTH BASE RECTANGLE	Laminate	796	70
PLRE-V			Veneer	940	70

\*Bases standard in 22" width. 30" width available, please contact factory for pricing.



For applicable Power & Data modules, please see Table Accessories Price List.



# BOARDGAMES TABLES

## BOARDROOM

### TABLETOP



MODEL	TABLETOPS		TOP AND EDGE SPECIFICATIONS						BASES		LBS
	Code	Number of Sections	For Laminate Top			For Veneer Top			Number of Bases Required		
			SE PVF 2MM	HF HB	HBV HBVR HBG	HF2 HB2 HKN4 HKNR4 HBG2	HF HB HBV HBVR HBG	HF2 HB2 HKN4 HKNR4 HBG2	BGEL BGRE BGHDR*	BGDR BGSQ BGDDR*	
<i>Video Conference Arc Ends</i>											
48 x 96	4896VCA	1	1318	3039	3301	3573	3954	4294	2	2	135
48 x 120	48120VCA	2	1598	3867	4193	4536	4682	5072	3	2	168
48 x 144	48144VCA	2	1925	4519	4909	5320	5841	6196	3	2	202
48 x 168	48168VCA	2	2340	5145	5596	6074	6316	6867	3	3	236
48 x 192	48192VCA	2	2581	5950	6524	7660	7967	8868	3	3	269
48 x 216	48216VCA	2	3227	6672	7319	8728	9077	9953	3	3	303
60 x 120	60120VCA	2	1999	4833	5240	5671	5852	6338	3	2	210
60 x 144	60144VCA	2	2406	5649	6137	6653	7301	7744	3	2	252
60 x 168	60168VCA	2	2925	6431	6996	7591	7894	8582	3	3	294
60 x 192	60192VCA	2	3508	7718	8396	9107	9473	10298	3	3	336
60 x 216	60216VCA	2	3948	8683	9445	10249	10657	11586	3	3	378

When specifying Half Drum (BGHDR) or D-Drum (BGDDR) bases where 3 bases are required, the middle base should be specified as a Rectangle base (BGRE).

## BASES

MODEL	BASE SHAPES	FINISH	BASE PRICE	LBS	
		<i>Aluminum or Wood Trim</i>			
BGDR-L		BOARDGAME DRUM	Laminate	1206	75
BGDR-V			Veneer	1351	75
BGRE-L		BOARDGAME RECTANGLE	Laminate	796	70
BGRE-V			Veneer	940	70
BGSQ-L		BOARDGAME SQUARE	Laminate	796	70
BGSQ-V			Veneer	940	70
BGEL-L		BOARDGAME ELLIPSE	Laminate	855	65
BGEL-V			Veneer	999	65
BGDDR-L		BOARDGAME D-DRUM	Laminate	1347	85
BGDDR-V			Veneer	1492	85
BGHDR-L		BOARDGAME HALF DRUM	Laminate	972	65
BGHDR-V			Veneer	1115	65
PLDR-L		PLINTH BASE DRUM	Laminate	1206	75
PLDR-V			Veneer	1351	75
PLSQ-L		PLINTH BASE SQUARE	Laminate	796	70
PLSQ-V			Veneer	940	70
PLRE-L		PLINTH BASE RECTANGLE	Laminate	796	70
PLRE-V			Veneer	940	70

\*Bases standard in 22" width. 30" width available, please contact factory for pricing.



For applicable Power & Data modules, please see Table Accessories Price List.

# BOARDGAMES TABLES

## TABLETOP SECTIONS AND SEATING LAYOUTS

RECTANGLE		
Size / Shape	Number of Tabletop Sections	Number of Chairs (based on 25" wide chairs)
48 x 96RE	1	8
48 x 120RE	2	10
48 x 144RE	2	10
48 x 168RE	2	12
48 x 192RE	2	14
48 x 216RE	2	14
60 x 120RE	2	10
60 x 144RE	2	12
60 x 168RE	2	12
60 x 192RE	2	14
60 x 216RE	2	16

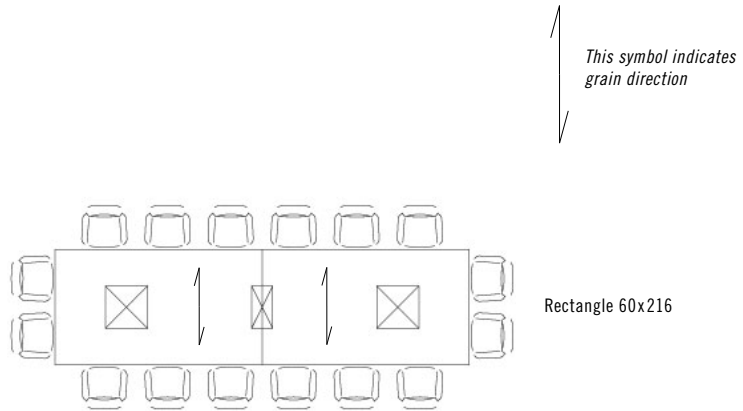

Rectangle 60x216

RACETRACK		
Size / Shape	Number of Tabletop Sections	Number of Chairs (based on 25" wide chairs)
48 x 96RT	1	8
48 x 120RT	2	10
48 x 144RT	2	10
48 x 168RT	2	12
48 x 192RT	2	14
48 x 216RT	2	14
60 x 120RT	2	10
60 x 144RT	2	12
60 x 168RT	2	12
60 x 192RT	2	14
60 x 216RT	2	16

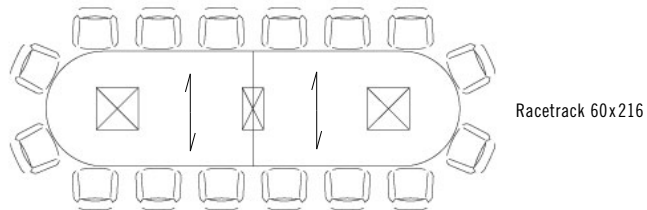

Racetrack 60x216

RECTANGLE ARC ENDS		
Size / Shape	Number of Tabletop Sections	Number of Chairs (based on 25" wide chairs)
48 x 96REA	1	8
48 x 120REA	2	10
48 x 144REA	2	10
48 x 168REA	2	12
48 x 192REA	2	14
48 x 216REA	2	14
60 x 120REA	2	10
60 x 144REA	2	12
60 x 168REA	2	12
60 x 192REA	2	14
60 x 216REA	2	16

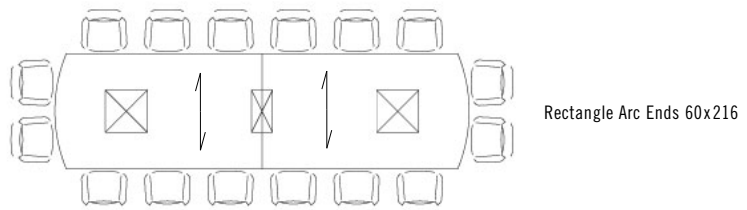

Rectangle Arc Ends 60x216

# BOARDGAMES TABLES

## TABLETOP SECTIONS AND SEATING LAYOUTS

BOATSHAPE		
Size / Shape	Number of Tabletop Sections	Number of Chairs (based on 25" wide chairs)
48 x 96BT	1	8
48 x 120BT	2	10
48 x 144BT	2	10
48 x 168BT	2	12
48 x 192BT	2	14
48 x 216BT	2	14
60 x 120BT	2	10
60 x 144BT	2	12
60 x 168BT	2	12
60 x 192BT	2	14
60 x 216BT	2	16
<i>Standard with 12" Taper</i>		

BOATSHAPE ARC ENDS		
Size / Shape	Number of Tabletop Sections	Number of Chairs (based on 25" wide chairs)
48 x 96BTA	1	8
48 x 120BTA	2	10
48 x 144BTA	2	10
48 x 168BTA	2	12
48 x 192BTA	2	14
48 x 216BTA	2	14
60 x 120BTA	2	10
60 x 144BTA	2	12
60 x 168BTA	2	12
60 x 192BTA	2	14
60 x 216BTA	2	16

ELLIPSE		
Size / Shape	Number of Tabletop Sections	Number of Chairs (based on 25" wide chairs)
48 x 96EL	1	6
48 x 120EL	2	6
48 x 144EL	2	8
48 x 168EL	2	10
48 x 192EL	2	10
48 x 216EL	2	12
60 x 120EL	2	8
60 x 144EL	2	10
60 x 168EL	2	10
60 x 192EL	2	12
60 x 216EL	2	14

This symbol indicates grain direction

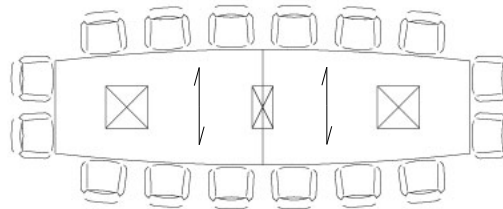

Boatshape 60x216

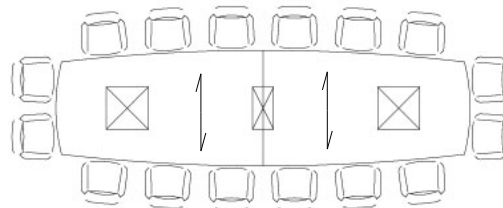

Boatshape Arc Ends 60x216

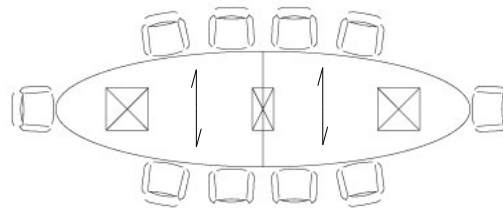

Ellipse 60x216



# BOARDGAMES TABLES

## TABLETOP SECTIONS AND SEATING LAYOUTS

VIDEO CONFERENCE		
Size / Shape	Number of Tabletop Sections	Number of Chairs (based on 25" wide chairs)
48 x 96VC	1	4
48 x 120VC	2	6
48 x 144VC	2	6
48 x 168VC	2	8
48 x 192VC	2	10
48 x 216VC	2	10
60 x 120VC	2	6
60 x 144VC	2	6
60 x 168VC	2	8
60 x 192VC	2	14
60 x 216VC	2	16
<i>Standard with 12" Taper</i>		

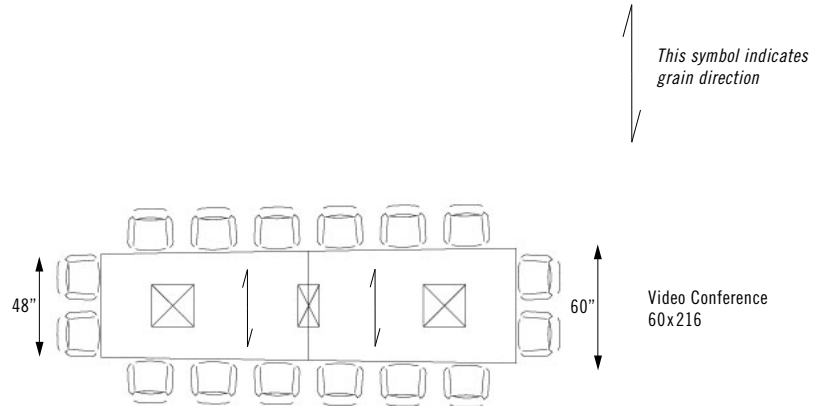

VIDEO CONFERENCE ARC		
Size / Shape	Number of Tabletop Sections	Number of Chairs (based on 25" wide chairs)
48 x 96VCA	1	4
48 x 120VCA	2	6
48 x 144VCA	2	6
48 x 168VCA	2	8
48 x 192VCA	2	10
48 x 216VCA	2	10
60 x 120VCA	2	6
60 x 144VCA	2	6
60 x 168VCA	2	8
60 x 192VCA	2	14
60 x 216VCA	2	16
<i>Standard with 12" Taper</i>		

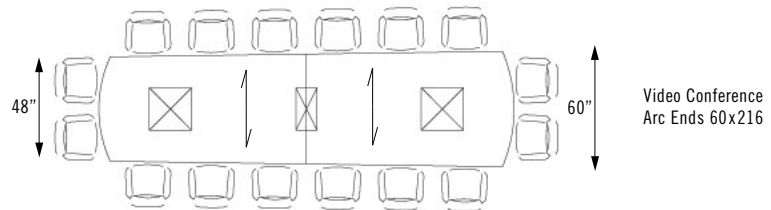

## LARGER TABLE SIZES

Boardgames tabletops with a length of 108" to 216" and a width that doesn't exceeds 60", will be made in 2 equal pieces. Boardgames tabletops with a length of 216" to 324" and a width that doesn't exceed 60", will be made in 3 equal pieces. All multiple piece tabletops are tight joint fastened. Bases standard in 22" width. 30" width available. Please contact factory for pricing.

## WOOD FINISHES AND GRAIN DIRECTION

### Finishes

Veneers and hardwood edge finishes are available in our 9 standard stains or stain-to-match which is never an upcharge.

### Grain Direction

The grain on a single piece boardroom tabletop will run lengthwise. The grain on a 2 piece or more top runs from side to side, signified on line drawing with grain direction symbol. Laminates with wood grain patterns follow the same direction as veneer wood grains.



# BOARDGAMES TABLES

## POWER AND VOICE/DATA MODULES

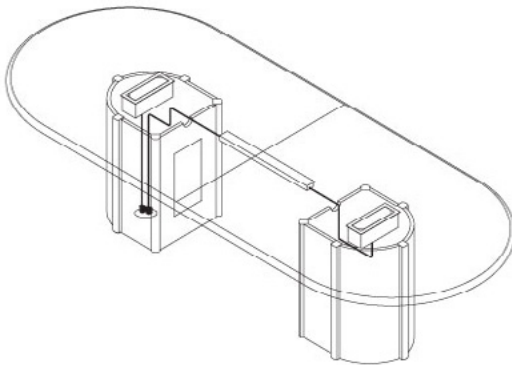
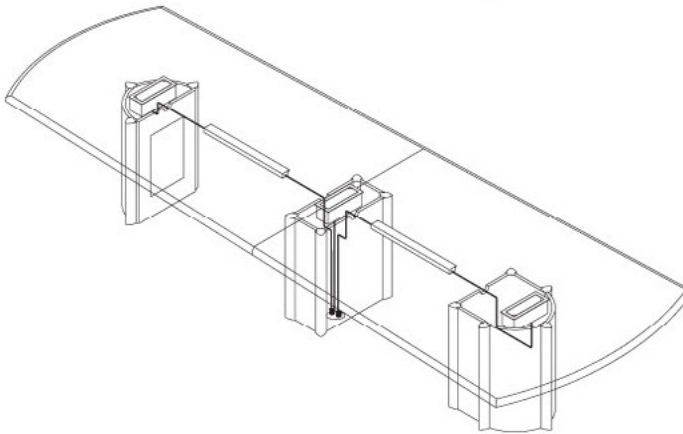
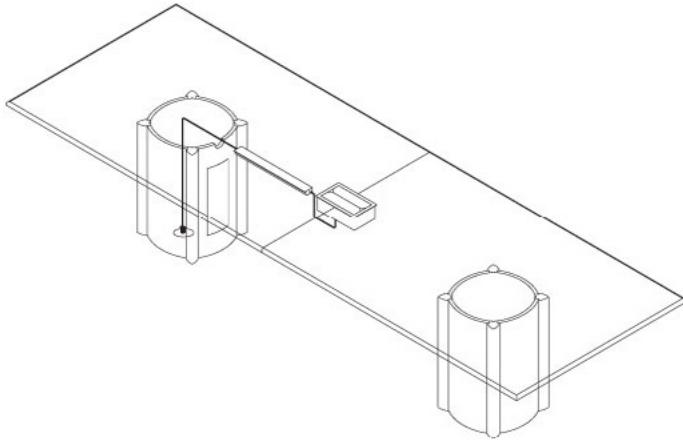

BGDR  
Drum



BGHDR  
Half Drum



BGDDR  
D Drum



BGEL  
Ellipse

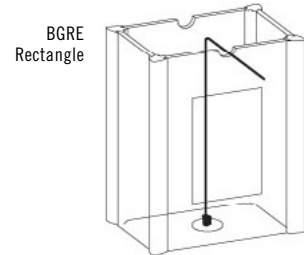

BGRE  
Rectangle

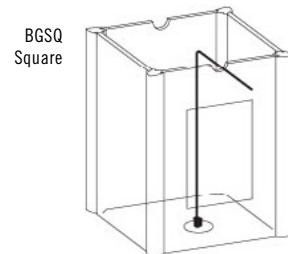

BGSQ  
Square

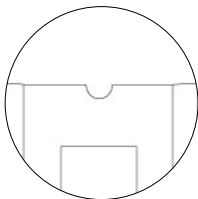

All Boardgames bases are standard with a touch latch removable door and a 3" cutout for wire pass-through at the top

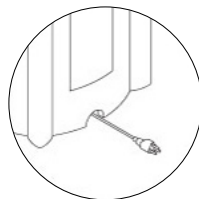

Optional cutout for wire pass-through at the bottom of Boardgames bases must be specified if required

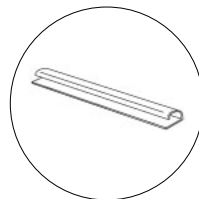

Tops are standard with 24" PVC under table wire manager between bases