



BOARDGAMES TABLES



HOW TO ORDER

Boardgames is a series of tabletops and bases that allows complete flexibility when specifying boardrooms, meeting rooms, video conferencing and training areas.

For simplicity and ease of choice, tabletops and bases are priced separately. All bases are standard with a touch latch door for wire access and a cutout at the top for wire pass-through.



Step 1 - Select the tabletop

1. Choose the shape and size of the tabletop
 - see tabletop shapes
 - see tabletop dimensions and finishes
 - see tabletop sections and seating layouts
2. Choose laminate or veneer top finish
3. Choose an edge profile in hardwood, self edge, PVC or 2mm Edge

Step 2 - Select the base

1. Choose a base design
 - be sure to select the correct number of bases required for the table
2. Choose a base finish
 - laminate or veneer
3. Choose a base trim profile
 - aluminum extrusion or wood
4. Choose the finish of the base trim profile
 - if aluminum extrusion, choose any Spectone color
 - if wood, choose from 9 standard stains or stain-to-match at no upcharge

Step 3 - Select power and communication modules (if required)

1. Determine the number and type of modules required on the table
2. For each module select the appropriate power and data configuration.

For applicable Power & Data modules, please see Table Accessories Price List.



Pricing August 2017
Discount 57.7% from List prices



BOARDGAMES TABLES



PLACING AN ORDER IS EASY

PRODUCT CODE

4896 RE BG DR - L

Size Width x Length	Top Shape D : Round SQ : Square RE : Rectangle REA: Rectangle Arc RT : Racetrack BT : Boatshape BTA : Boatshape Arc	EL : Ellipse VC : Video Conference VCA : Video Conference Arc	Series BG : Boardgame PL : Plinth	Base Shape DR : Drum RE : Rectangle SQ : Square EL : Ellipse DDR : D-Drum HDR : Half Drum	Finish L : Laminate V : Veneer
-------------------------------	---	---	--	--	---



OPTIONS

BASE



TRIM DETAIL



FINISHES

LAMINATE

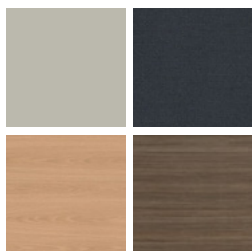

Select from 15 standard laminates or choose any standard Wilsonart, Nevamar, Formica, Arborite and Pionite matte finish laminates at no upcharge

VENEER



Select from one of our 9 standard wood stains or stain-to-match at no upcharge

ALUMINUM BASE TRIM



Select from one of our 76 standard Spectone colors

EDGE



Check out our website for a complete list of edge profiles.

Toll Free: 1-888-761-7732



BOARDGAMES TABLES

BOARDROOM

TABLETOP SHAPES

On one piece tabletops, grain direction runs lengthwise.

On tabletops of two or more pieces, grain direction runs from side to side, as standard.

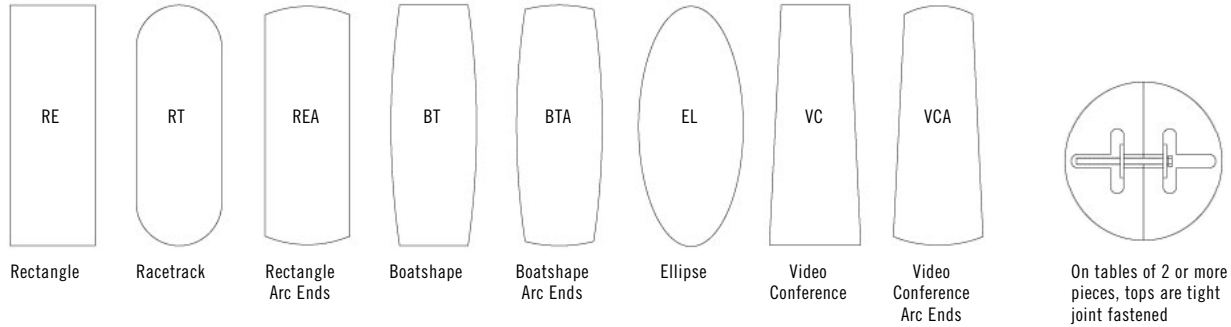

EDGE PROFILES

Boardgames tabletops in veneer or laminate can be specified with any one of our standard hardwood edge profiles. Also available in self edge (SE), PVC flat (PVF), and 2mm Bio and PVC Edges (2MM).

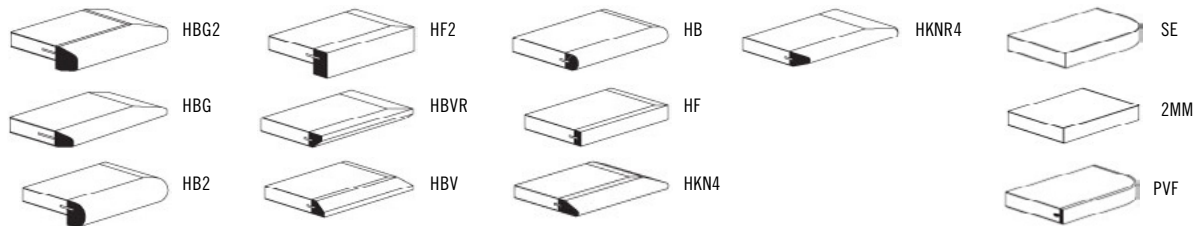

BASE DESIGNS AND TRIM PROFILES

Boardgames - Base Designs

Six different Boardgames bases are available, in laminate or veneer, standard at 22" width. For 30" width options, please contact Spec™ Customer Service. Each base features trim profiles in your choice of aluminum extrusion or wood. Aluminum extrusion is available in any Spectone color at no upcharge.

Wood trim on base stained in any of Spec's 9 standard stain colors or stain-to-match at no upcharge. The bases are standard with a touch latch removable door for wire access and a cutout at the top for wire pass-through.

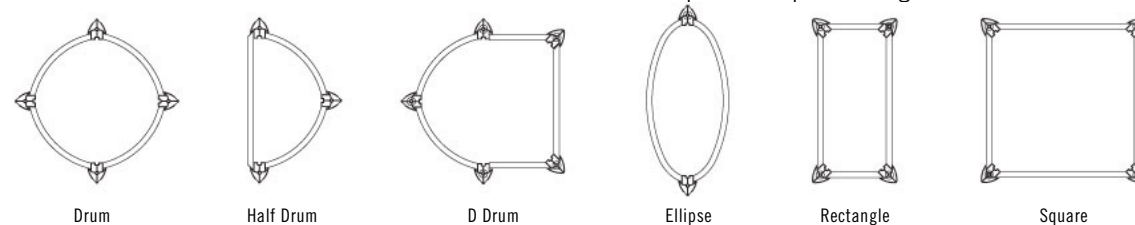

Boardgames - Base Trim Profiles

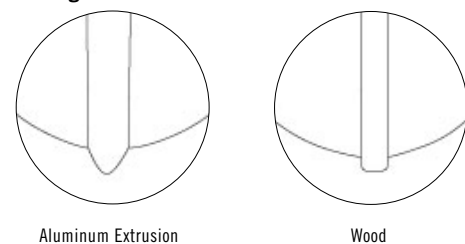



Pricing August 2017
Discount 57.7% from List prices



SIN 711-11

BOARDGAMES TABLES

BOARDROOM

TABLETOP



MODEL	TABLETOPS		TOP AND EDGE SPECIFICATIONS						BASES			LBS	
	Code	Number of Sections	For Laminate Top			For Veneer Top			Number of Bases Required				
			SE PVF 2MM	HF HB	HBV HBVR HBG	HF2 HB2 HKN4 HKNR4 HBG2	HF HB HBV HBVR HBG	HF2 HB2 HKN4 HKNR4 HBG2	BGDR	BGSQ	PLDR	PLSQ	
<i>Round</i>													
42	42D	1	622	1160	1276	1523	1548	1840	1				110
48	48D	1	644	1366	1492	1615	2057	2433	1				126
54	54D	1	915	1979	2175	2362	2583	3064	1				146
60	60D	1	959	2168	2377	2535	3175	3774	1				165



BASES

MODEL	BASE SHAPES	FINISH	BASE PRICE	LBS
		<i>Aluminum or Wood Trim</i>		
BGDR-L	 BOARDGAME DRUM	Laminate	1381	75
BGDR-V	 BOARDGAME DRUM	Veneer	1544	75
BGSQ-L	 BOARDGAME SQUARE	Laminate	912	70
BGSQ-V	 BOARDGAME SQUARE	Veneer	1075	70
PLDR-L	 PLINTH BASE DRUM	Laminate	1381	75
PLDR-V	 PLINTH BASE DRUM	Veneer	1544	75
PLSQ-L	 PLINTH BASE SQUARE	Laminate	912	70
PLSQ-V	 PLINTH BASE SQUARE	Veneer	1075	70

*Bases standard in 22" width. 30" width available, please contact factory for pricing.



BGDR



BGSQ



PLSQ



PLDR

For applicable Power & Data modules, please see Table Accessories Price List.

Toll Free: 1-888-761-7732



Pricing August 2017
Discount 57.7% from List prices



SIN 711-11

BOARDGAMES TABLES

BOARDROOM

TABLETOP



MODEL	TABLETOPS		TOP AND EDGE SPECIFICATIONS						BASES		LBS
	Code	Number of Sections	For Laminate Top			For Veneer Top			Number of Bases Required		
			SE PVF 2MM	HF HB	HBV HBVR HBG	HF2 HB2 HKN4 HKNR4 HBG2	HF HB HBV HBVR HBG	HF2 HB2 HKN4 HKNR4 HBG2	BGDR BGSQ PLDR PLSQ		
<i>Square</i>											
36 x 36	36SQ	1	374	582	640	836	843	1030	1	98	
42 x 42	42SQ	1	636	937	1030	1123	1187	1443	1	112	
48 x 48	48SQ	1	780	1044	1142	1185	1539	1868	1	128	
54 x 54	54SQ	1	917	1500	1653	1831	1928	2354	1	146	
60 x 60	60SQ	1	946	1599	1762	1941	2375	2891	1	165	



BASES

MODEL	BASE SHAPES	FINISH	BASE PRICE	LBS	
		<i>Aluminum or Wood Trim</i>			
BGDR-L		BOARDGAME DRUM	Laminate	1381	75
BGDR-V			Veneer	1544	75
BGSQ-L		BOARDGAME SQUARE	Laminate	912	70
BGSQ-V			Veneer	1075	70
PLDR-L		PLINTH BASE DRUM	Laminate	1381	75
PLDR-V			Veneer	1544	75
PLSQ-L		PLINTH BASE SQUARE	Laminate	912	70
PLSQ-V			Veneer	1075	70

*Bases standard in 22" width. 30" width available, please contact factory for pricing.



BGDR



BGSQ



PLSQ



PLDR

For applicable Power & Data modules, please see Table Accessories Price List.

Toll Free: 1-888-761-7732



Pricing August 2017
Discount 57.7% from List prices



SIN 711-11

BOARDGAMES TABLES

BOARDROOM

TABLETOP



MODEL	TABLETOPS		TOP AND EDGE SPECIFICATIONS						BASES		LBS
	Code	Number of Sections	For Laminate Top			For Veneer Top			Number of Bases Required		
			SE PVF 2MM	HF HB	HBV HBVR HBG	HF2 HB2 HKN4 HKNR4 HBG2	HF HB HBV HBVR HBG	HF2 HB2 HKN4 HKNR4 HBG2	BGEL BGRE BGHDR*	BGDR BGSQ BGDDR* PLDR PLSQ	
<i>Rectangle</i>											
48 x 96	4896RE	1	1324	2174	2404	2636	2980	3645	2	2	135
48 x 120	48120RE	2	1640	2737	2997	3557	3640	4417	3	2	168
48 x 144	48144RE	2	2010	3583	3925	4458	4332	5267	3	2	202
48 x 168	48168RE	2	2481	4064	4454	5199	5027	6114	3	3	236
48 x 192	48192RE	2	2782	4844	5318	6380	6017	7317	3	3	269
48 x 216	48216RE	2	3358	5400	5922	7051	6708	8173	3	3	303
60 x 120	60120RE	2	2092	3732	4090	4644	4512	5487	3	2	210
60 x 144	60144RE	2	2511	4479	4908	5571	5415	6584	3	2	252
60 x 168	60168RE	2	2930	5226	5724	6501	6317	7681	3	3	294
60 x 192	60192RE	2	3519	6272	6868	7800	7581	9217	3	3	336
60 x 216	60216RE	2	3957	7055	7730	8775	8528	10367	3	3	378

When specifying Half Drum (BGHDR) or D-Drum (BGDDR) bases where 3 bases are required, the middle base should be specified as a Rectangle base (BGRE).

BASES

MODEL	BASE SHAPES	FINISH	BASE PRICE	LBS	
		<i>Aluminum or Wood Trim</i>			
BGDR-L		BOARDGAME DRUM	Laminate	1381	75
BGDR-V			Veneer	1544	75
BGRE-L		BOARDGAME RECTANGLE	Laminate	912	70
BGRE-V			Veneer	1075	70
BGSQ-L		BOARDGAME SQUARE	Laminate	912	70
BGSQ-V			Veneer	1075	70
BGEL-L		BOARDGAME ELLIPSE	Laminate	977	65
BGEL-V			Veneer	1143	65
BGDDR-L		BOARDGAME D-DRUM	Laminate	1541	85
BGDDR-V			Veneer	1709	85
BGHDR-L		BOARDGAME HALF DRUM	Laminate	1112	65
BGHDR-V			Veneer	1277	65
PLDR-L		PLINTH BASE DRUM	Laminate	1381	75
PLDR-V			Veneer	1544	75
PLSQ-L		PLINTH BASE SQUARE	Laminate	912	70
PLSQ-V			Veneer	1075	70
PLRE-L		PLINTH BASE RECTANGLE	Laminate	912	70
PLRE-V			Veneer	1075	70

*Bases standard in 22" width. 30" width available, please contact factory for pricing.



For applicable Power & Data modules, please see Table Accessories Price List.

Toll Free: 1-888-761-7732



Pricing August 2017
Discount 57.7% from List prices



SIN 711-11

BOARDGAMES TABLES

BOARDROOM

TABLETOP



MODEL	TABLETOPS		TOP AND EDGE SPECIFICATIONS						BASES		LBS
	Code	Number of Sections	For Laminate Top			For Veneer Top			Number of Bases Required		
			SE PVF 2MM	HF HB	HBV HBVR HBG	HF2 HB2 HKN4 HKNR4 HBG2	HF HB HBV HBVR HBG	HF2 HB2 HKN4 HKNR4 HBG2	BGEL BGRE BGHDR*	BGDR BGSQ BGDDR* PLDR PLSQ	
<i>Rectangle Arc Ends</i>											
48 x 96	4896REA	1	1344	2304	2538	3101	3499	4208	2	2	135
48 x 120	48120REA	2	1665	3189	3494	4270	4237	5065	3	2	168
48 x 144	48144REA	2	2038	3936	4310	5272	5049	6053	3	2	202
48 x 168	48168REA	2	2511	4575	5012	6080	5872	7036	3	3	236
48 x 192	48192REA	2	2686	5381	5901	6930	7205	8021	3	3	269
48 x 216	48216REA	2	3358	6034	6620	7896	8211	9004	3	3	303
60 x 120	60120REA	2	2082	3986	4365	5340	5296	6335	3	2	210
60 x 144	60144REA	2	2548	4919	5389	6593	6313	7567	3	2	252
60 x 168	60168REA	2	3141	5721	6267	7598	7341	8795	3	3	294
60 x 192	60192REA	2	3767	6865	7521	9118	9484	10555	3	3	336
60 x 216	60216REA	2	4238	7722	8460	10258	10669	11874	3	3	378

When specifying Half Drum (BGHDR) or D-Drum (BGDDR) bases where 3 bases are required, the middle base should be specified as a Rectangle base (BGRE).

BASES

MODEL	BASE SHAPES	FINISH	BASE PRICE	LBS	
		<i>Aluminum or Wood Trim</i>			
BGDR-L		BOARDGAME DRUM	Laminate	1381	75
BGDR-V			Veneer	1544	75
BGRE-L		BOARDGAME RECTANGLE	Laminate	912	70
BGRE-V			Veneer	1075	70
BGSQ-L		BOARDGAME SQUARE	Laminate	912	70
BGSQ-V			Veneer	1075	70
BGEL-L		BOARDGAME ELLIPSE	Laminate	977	65
BGEL-V			Veneer	1143	65
BGDDR-L		BOARDGAME D-DRUM	Laminate	1541	85
BGDDR-V			Veneer	1709	85
BGHDR-L		BOARDGAME HALF DRUM	Laminate	1112	65
BGHDR-V			Veneer	1277	65
PLDR-L		PLINTH BASE DRUM	Laminate	1381	75
PLDR-V			Veneer	1544	75
PLSQ-L		PLINTH BASE SQUARE	Laminate	912	70
PLSQ-V			Veneer	1075	70
PLRE-L		PLINTH BASE RECTANGLE	Laminate	912	70
PLRE-V			Veneer	1075	70

*Bases standard in 22" width. 30" width available, please contact factory for pricing.



For applicable Power & Data modules, please see Table Accessories Price List.

Toll Free: 1-888-761-7732



Pricing August 2017
Discount 57.7% from List prices



SIN 711-11

BOARDGAMES TABLES

BOARDROOM

TABLETOP



MODEL	TABLETOPS		TOP AND EDGE SPECIFICATIONS						BASES		LBS
	Code	Number of Sections	For Laminate Top			For Veneer Top			Number of Bases Required		
			SE PVF 2MM	HF HB	HBV HBV HBG	HF2 HB2 HKN4 HKNR4 HBG2	HF HB HBV HBV HBG	HF2 HB2 HKN4 HKNR4 HBG2	BGEL BGRE BGHDR*	BGDR BGSQ BGDDR*	
<i>Racetrack</i>											
48 x 96	4896RT	1	1344	2304	2538	3101	3499	4208	2	2	135
48 x 120	48120RT	2	1665	3189	3494	4270	4237	5065	3	2	168
48 x 144	48144RT	2	2038	3936	4310	5272	5049	6053	3	2	202
48 x 168	48168RT	2	2511	4575	5012	6080	5872	7036	3	3	236
48 x 192	48192RT	2	2686	5381	5901	6930	7205	8021	3	3	269
48 x 216	48216RT	2	3358	6034	6620	7896	8211	9004	3	3	303
60 x 120	60120RT	2	2082	3986	4365	5340	5296	6335	3	2	210
60 x 144	60144RT	2	2548	4919	5389	6593	6313	7567	3	2	252
60 x 168	60168RT	2	3141	5721	6267	7598	7341	8795	3	3	294
60 x 192	60192RT	2	3767	6865	7521	9118	9484	10555	3	3	336
60 x 216	60216RT	2	4238	7722	8460	10258	10669	11874	3	3	378

When specifying Half Drum (BGHDR) or D-Drum (BGDDR) bases where 3 bases are required, the middle base should be specified as a Rectangle base (BGRE).

BASES

MODEL	BASE SHAPES	FINISH	BASE PRICE	LBS	
		<i>Aluminum or Wood Trim</i>			
BGDR-L		BOARDGAME DRUM	Laminate	1381	75
BGDR-V			Veneer	1544	75
BGRE-L		BOARDGAME RECTANGLE	Laminate	912	70
BGRE-V			Veneer	1075	70
BGSQ-L		BOARDGAME SQUARE	Laminate	912	70
BGSQ-V			Veneer	1075	70
BGEL-L		BOARDGAME ELLIPSE	Laminate	977	65
BGEL-V			Veneer	1143	65
BGDDR-L		BOARDGAME D-DRUM	Laminate	1541	85
BGDDR-V			Veneer	1709	85
BGHDR-L		BOARDGAME HALF DRUM	Laminate	1112	65
BGHDR-V			Veneer	1277	65
PLDR-L		PLINTH BASE DRUM	Laminate	1381	75
PLDR-V			Veneer	1544	75
PLSQ-L		PLINTH BASE SQUARE	Laminate	912	70
PLSQ-V			Veneer	1075	70
PLRE-L		PLINTH BASE RECTANGLE	Laminate	912	70
PLRE-V			Veneer	1075	70

*Bases standard in 22" width. 30" width available, please contact factory for pricing.

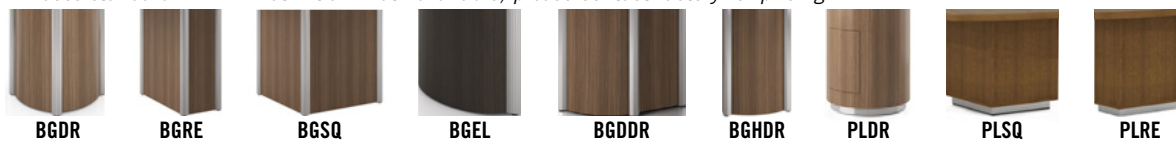

For applicable Power & Data modules, please see Table Accessories Price List.

Toll Free: 1-888-761-7732



Pricing August 2017
Discount 57.7% from List prices



SIN 711-11

BOARDGAMES TABLES

BOARDROOM

TABLETOP



MODEL	TABLETOPS		TOP AND EDGE SPECIFICATIONS						BASES		LBS
	Code	Number of Sections	For Laminate Top			For Veneer Top			Number of Bases Required		
			SE PVF 2MM	HF HB	HBV HBVR HBG	HF2 HB2 HKN4 HKNR4 HBG2	HF HB HBV HBVR HBG	HF2 HB2 HKN4 HKNR4 HBG2	BGEL BGRE BGHDR*	BGDR BGSQ BGDDR* PLDR PLSQ	
<i>Boatshape</i>											
48 x 96	4896BT	1	1344	2959	3260	3570	4010	4396	2	2	135
48 x 120	48120BT	2	1665	3907	4280	4673	4841	5287	3	2	168
48 x 144	48144BT	2	2038	4654	5099	5571	6167	6573	3	2	202
48 x 168	48168BT	2	2511	5369	5886	6432	6711	7338	3	3	236
48 x 192	48192BT	2	2686	6191	6787	7968	8285	9224	3	3	269
48 x 216	48216BT	2	3358	6938	7611	9080	9443	10353	3	3	303
60 x 120	60120BT	2	2082	4882	5351	5842	6053	6608	3	2	210
60 x 144	60144BT	2	2548	5819	6375	6966	7708	8217	3	2	252
60 x 168	60168BT	2	3141	6714	7359	8042	8386	9173	3	3	294
60 x 192	60192BT	2	3767	8055	8830	9650	10064	11007	3	3	336
60 x 216	60216BT	2	4238	9062	9936	10857	11322	12384	3	3	378

When specifying Half Drum (BGHDR) or D-Drum (BGDDR) bases where 3 bases are required, the middle base should be specified as a Rectangle base (BGRE).

BASES

MODEL	BASE SHAPES	FINISH	BASE PRICE	LBS	
		<i>Aluminum or Wood Trim</i>			
BGDR-L		BOARDGAME DRUM	Laminate	1381	75
BGDR-V			Veneer	1544	75
BGRE-L		BOARDGAME RECTANGLE	Laminate	912	70
BGRE-V			Veneer	1075	70
BGSQ-L		BOARDGAME SQUARE	Laminate	912	70
BGSQ-V			Veneer	1075	70
BGEL-L		BOARDGAME ELLIPSE	Laminate	977	65
BGEL-V			Veneer	1143	65
BGDDR-L		BOARDGAME D-DRUM	Laminate	1541	85
BGDDR-V			Veneer	1709	85
BGHDR-L		BOARDGAME HALF DRUM	Laminate	1112	65
BGHDR-V			Veneer	1277	65
PLDR-L		PLINTH BASE DRUM	Laminate	1381	75
PLDR-V			Veneer	1544	75
PLSQ-L		PLINTH BASE SQUARE	Laminate	912	70
PLSQ-V			Veneer	1075	70
PLRE-L		PLINTH BASE RECTANGLE	Laminate	912	70
PLRE-V			Veneer	1075	70

*Bases standard in 22" width. 30" width available, please contact factory for pricing.

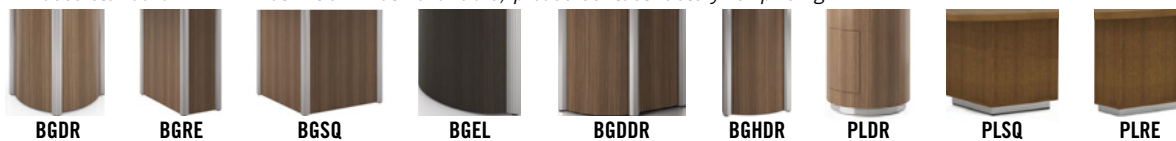

For applicable Power & Data modules, please see Table Accessories Price List.

Toll Free: 1-888-761-7732



Pricing August 2017
Discount 57.7% from List prices



SIN 711-11

BOARDGAMES TABLES

BOARDROOM

TABLETOP

MODEL	TABLETOPS		TOP AND EDGE SPECIFICATIONS						BASES		LBS
	Code	Number of Sections	For Laminate Top			For Veneer Top			Number of Bases Required		
			SE PVF 2MM	HF HB	HBV HBV HBG	HF2 HB2 HKN4 HKNR4 HBG2	HF HB HBV HBVR HBG	HF2 HB2 HKN4 HKNR4 HBG2	BGEL BGRE BGHDR*	BGDR BGSQ BGDDR*	
<i>Boatshape Arc Ends</i>											
48 x 96	4896BTA	1	1508	3474	3776	4088	4525	4912	2	2	135
48 x 120	48120BTA	2	1829	4424	4797	5191	5358	5802	3	2	168
48 x 144	48144BTA	2	2202	5169	5617	6089	6682	7090	3	2	202
48 x 168	48168BTA	2	2676	5886	6405	6950	7226	7856	3	3	236
48 x 192	48192BTA	2	2955	6810	7465	8766	9116	10147	3	3	269
48 x 216	48216BTA	2	3692	7634	8374	9987	10388	11390	3	3	303
60 x 120	60120BTA	2	2288	5530	5996	6488	6697	7252	3	2	210
60 x 144	60144BTA	2	2752	6463	7022	7611	8354	8861	3	2	252
60 x 168	60168BTA	2	3345	7359	8005	8685	9034	9821	3	3	294
60 x 192	60192BTA	2	4015	8830	9606	10421	10840	11785	3	3	336
60 x 216	60216BTA	2	4518	9936	10808	11725	12194	13257	3	3	378

When specifying Half Drum (BGHDR) or D-Drum (BGDDR) bases where 3 bases are required, the middle base should be specified as a Rectangle base (BGRE).

BASES

MODEL	BASE SHAPES	FINISH	BASE PRICE	LBS	
		<i>Aluminum or Wood Trim</i>			
BGDR-L		BOARDGAME DRUM	Laminate	1381	75
BGDR-V			Veneer	1544	75
BGRE-L		BOARDGAME RECTANGLE	Laminate	912	70
BGRE-V			Veneer	1075	70
BGSQ-L		BOARDGAME SQUARE	Laminate	912	70
BGSQ-V			Veneer	1075	70
BGEL-L		BOARDGAME ELLIPSE	Laminate	977	65
BGEL-V			Veneer	1143	65
BGDDR-L		BOARDGAME D-DRUM	Laminate	1541	85
BGDDR-V			Veneer	1709	85
BGHDR-L		BOARDGAME HALF DRUM	Laminate	1112	65
BGHDR-V			Veneer	1277	65
PLDR-L		PLINTH BASE DRUM	Laminate	1381	75
PLDR-V			Veneer	1544	75
PLSQ-L		PLINTH BASE SQUARE	Laminate	912	70
PLSQ-V			Veneer	1075	70
PLRE-L		PLINTH BASE RECTANGLE	Laminate	912	70
PLRE-V			Veneer	1075	70

*Bases standard in 22" width. 30" width available, please contact factory for pricing.



For applicable Power & Data modules, please see Table Accessories Price List.

Toll Free: 1-888-761-7732



Pricing August 2017
Discount 57.7% from List prices



SIN 711-11

BOARDGAMES TABLES

BOARDROOM

TABLETOP

MODEL	TABLETOPS		TOP AND EDGE SPECIFICATIONS						BASES		LBS
	Code	Number of Sections	For Laminate Top			For Veneer Top			Number of Bases Required		
			SE PVF 2MM	HF HB	HBV HBVR HBG	HF2 HB2 HKN4 HKNR4 HBG2	HF HB HBV HBVR HBG	HF2 HB2 HKN4 HKNR4 HBG2	BGEL BGRE BGHDR*	BGDR BGSQ BGDDR* PLDR PLSQ	
<i>Ellipse</i>											
48 x 96	4896EL	1	1613	3550	3912	4285	4810	5273	2	2	135
48 x 120	48120EL	2	1999	4688	5137	5608	5811	6342	3	2	168
48 x 144	48144EL	2	2445	5585	6119	6687	7400	7889	3	2	202
48 x 168	48168EL	2	3015	6443	7065	7718	8026	8807	3	3	236
48 x 192	48192EL	2	3249	7491	8212	9641	10028	11162	3	3	269
48 x 216	48216EL	2	4062	8397	9211	10985	11425	12529	3	3	303
60 x 120	60120EL	2	2632	6360	6895	7461	7702	8340	3	2	210
60 x 144	60144EL	2	3165	7432	8074	8754	9606	10191	3	2	252
60 x 168	60168EL	2	3847	8464	9207	9989	10390	11293	3	3	294
60 x 192	60192EL	2	4618	10154	11047	11985	12466	13553	3	3	336
60 x 216	60216EL	2	5196	11425	12429	13483	14024	15245	3	3	378

When specifying Half Drum (BGHDR) or D-Drum (BGDDR) bases where 3 bases are required, the middle base should be specified as a Rectangle base (BGRE).

BASES

MODEL	BASE SHAPES	FINISH	BASE PRICE	LBS	
		<i>Aluminum or Wood Trim</i>			
BGDR-L		BOARDGAME DRUM	Laminate	1381	75
BGDR-V			Veneer	1544	75
BGRE-L		BOARDGAME RECTANGLE	Laminate	912	70
BGRE-V			Veneer	1075	70
BGSQ-L		BOARDGAME SQUARE	Laminate	912	70
BGSQ-V			Veneer	1075	70
BGEL-L		BOARDGAME ELLIPSE	Laminate	977	65
BGEL-V			Veneer	1143	65
BGDDR-L		BOARDGAME D-DRUM	Laminate	1541	85
BGDDR-V			Veneer	1709	85
BGHDR-L		BOARDGAME HALF DRUM	Laminate	1112	65
BGHDR-V			Veneer	1277	65
PLDR-L		PLINTH BASE DRUM	Laminate	1381	75
PLDR-V			Veneer	1544	75
PLSQ-L		PLINTH BASE SQUARE	Laminate	912	70
PLSQ-V			Veneer	1075	70
PLRE-L		PLINTH BASE RECTANGLE	Laminate	912	70
PLRE-V			Veneer	1075	70

*Bases standard in 22" width. 30" width available, please contact factory for pricing.



For applicable Power & Data modules, please see Table Accessories Price List.

Toll Free: 1-888-761-7732



Pricing August 2017
Discount 57.7% from List prices



SIN 711-11

BOARDGAMES TABLES

BOARDROOM

TABLETOP



MODEL	TABLETOPS		TOP AND EDGE SPECIFICATIONS						BASES		LBS
	Code	Number of Sections	For Laminate Top			For Veneer Top			Number of Bases Required		
			SE PVF 2MM	HF HB	HBV HBVR HBG	HF2 HB2 HKN4 HKNR4 HBG2	HF HB HBV HBVR HBG	HF2 HB2 HKN4 HKNR4 HBG2	BGEL BGRE BGHDR*	BGDR BGSQ BGDDR*	
<i>Video Conference</i>											
48 x 96	4896VC	1	1344	2959	3260	3570	4010	4396	2	2	135
48 x 120	48120VC	2	1665	3907	4280	4673	4841	5287	3	2	168
48 x 144	48144VC	2	2038	4654	5099	5571	6167	6573	3	2	202
48 x 168	48168VC	2	2511	5369	5886	6432	6690	7338	3	3	236
48 x 192	48192VC	2	2686	6191	6787	7968	8285	9224	3	3	269
48 x 216	48216VC	2	3358	6938	7611	9080	9443	10353	3	3	303
60 x 120	60120VC	2	2082	4882	5351	5842	6053	6608	3	2	210
60 x 144	60144VC	2	2548	5819	6375	6966	7708	8217	3	2	252
60 x 168	60168VC	2	3141	6714	7359	8042	8386	9173	3	3	294
60 x 192	60192VC	2	3767	8055	8830	9650	10064	11007	3	3	336
60 x 216	60216VC	2	4238	9062	9936	10857	11322	12384	3	3	378

When specifying Half Drum (BGHDR) or D-Drum (BGDDR) bases where 3 bases are required, the middle base should be specified as a Rectangle base (BGRE).

BASES

MODEL	BASE SHAPES	FINISH	BASE PRICE	LBS	
		<i>Aluminum or Wood Trim</i>			
BGDR-L		BOARDGAME DRUM	Laminate	1381	75
BGDR-V			Veneer	1544	75
BGRE-L		BOARDGAME RECTANGLE	Laminate	912	70
BGRE-V			Veneer	1075	70
BGSQ-L		BOARDGAME SQUARE	Laminate	912	70
BGSQ-V			Veneer	1075	70
BGEL-L		BOARDGAME ELLIPSE	Laminate	977	65
BGEL-V			Veneer	1143	65
BGDDR-L		BOARDGAME D-DRUM	Laminate	1541	85
BGDDR-V			Veneer	1709	85
BGHDR-L		BOARDGAME HALF DRUM	Laminate	1112	65
BGHDR-V			Veneer	1277	65
PLDR-L		PLINTH BASE DRUM	Laminate	1381	75
PLDR-V			Veneer	1544	75
PLSQ-L		PLINTH BASE SQUARE	Laminate	912	70
PLSQ-V			Veneer	1075	70
PLRE-L		PLINTH BASE RECTANGLE	Laminate	912	70
PLRE-V			Veneer	1075	70

*Bases standard in 22" width. 30" width available, please contact factory for pricing.



For applicable Power & Data modules, please see Table Accessories Price List.

Toll Free: 1-888-761-7732



Pricing August 2017
Discount 57.7% from List prices



SIN 711-11

BOARDGAMES TABLES

BOARDROOM

TABLETOP



MODEL	TABLETOPS		TOP AND EDGE SPECIFICATIONS						BASES		LBS
	Code	Number of Sections	For Laminate Top			For Veneer Top			Number of Bases Required		
			SE PVF 2MM	HF HB	HBV HBV HBG	HF2 HB2 HKN4 HKNR4 HBG2	HF HB HBV HBVR HBG	HF2 HB2 HKN4 HKNR4 HBG2	BGEL BGRE BGHDR*	BGDR BGSQ BGDDR* PLDR PLSQ	
<i>Video Conference Arc Ends</i>											
48 x 96	4896VCA	1	1508	3474	3776	4088	4525	4912	2	2	135
48 x 120	48120VCA	2	1829	4424	4797	5191	5358	5802	3	2	168
48 x 144	48144VCA	2	2202	5169	5617	6089	6682	7090	3	2	202
48 x 168	48168VCA	2	2676	5886	6405	6950	7226	7856	3	3	236
48 x 192	48192VCA	2	2955	6810	7465	8766	9116	10147	3	3	269
48 x 216	48216VCA	2	3692	7634	8374	9987	10388	11390	3	3	303
60 x 120	60120VCA	2	2288	5530	5996	6488	6697	7252	3	2	210
60 x 144	60144VCA	2	2752	6463	7022	7611	8354	8861	3	2	252
60 x 168	60168VCA	2	3345	7359	8005	8685	9034	9821	3	3	294
60 x 192	60192VCA	2	4015	8830	9606	10421	10840	11785	3	3	336
60 x 216	60216VCA	2	4518	9936	10808	11725	12194	13257	3	3	378

When specifying Half Drum (BGHDR) or D-Drum (BGDDR) bases where 3 bases are required, the middle base should be specified as a Rectangle base (BGRE).

BASES

MODEL	BASE SHAPES	FINISH	BASE PRICE	LBS	
		<i>Aluminum or Wood Trim</i>			
BGDR-L		BOARDGAME DRUM	Laminate	1381	75
BGDR-V			Veneer	1544	75
BGRE-L		BOARDGAME RECTANGLE	Laminate	912	70
BGRE-V			Veneer	1075	70
BGSQ-L		BOARDGAME SQUARE	Laminate	912	70
BGSQ-V			Veneer	1075	70
BGEL-L		BOARDGAME ELLIPSE	Laminate	977	65
BGEL-V			Veneer	1143	65
BGDDR-L		BOARDGAME D-DRUM	Laminate	1541	85
BGDDR-V			Veneer	1709	85
BGHDR-L		BOARDGAME HALF DRUM	Laminate	1112	65
BGHDR-V			Veneer	1277	65
PLDR-L		PLINTH BASE DRUM	Laminate	1381	75
PLDR-V			Veneer	1544	75
PLSQ-L		PLINTH BASE SQUARE	Laminate	912	70
PLSQ-V			Veneer	1075	70
PLRE-L		PLINTH BASE RECTANGLE	Laminate	912	70
PLRE-V			Veneer	1075	70

*Bases standard in 22" width. 30" width available, please contact factory for pricing.



For applicable Power & Data modules, please see Table Accessories Price List.

Toll Free: 1-888-761-7732

BOARDGAMES TABLES

TABLETOP SECTIONS AND SEATING LAYOUTS

RECTANGLE		
Size / Shape	Number of Tabletop Sections	Number of Chairs (based on 25" wide chairs)
48 x 96RE	1	8
48 x 120RE	2	10
48 x 144RE	2	10
48 x 168RE	2	12
48 x 192RE	2	14
48 x 216RE	2	14
60 x 120RE	2	10
60 x 144RE	2	12
60 x 168RE	2	12
60 x 192RE	2	14
60 x 216RE	2	16

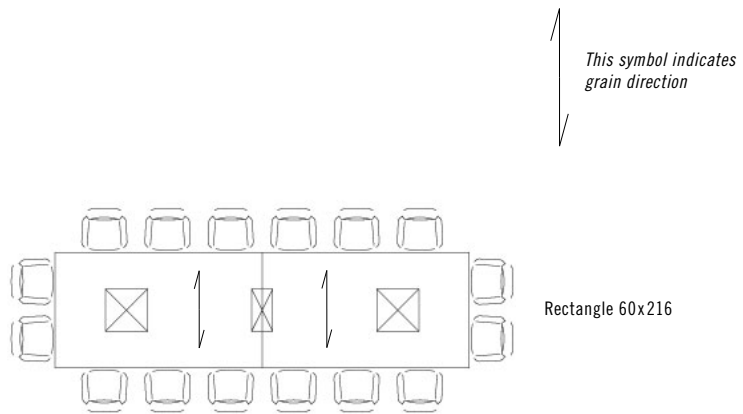

Rectangle 60x216

RACETRACK		
Size / Shape	Number of Tabletop Sections	Number of Chairs (based on 25" wide chairs)
48 x 96RT	1	8
48 x 120RT	2	10
48 x 144RT	2	10
48 x 168RT	2	12
48 x 192RT	2	14
48 x 216RT	2	14
60 x 120RT	2	10
60 x 144RT	2	12
60 x 168RT	2	12
60 x 192RT	2	14
60 x 216RT	2	16

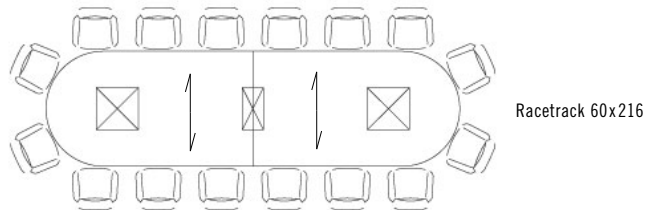

Racetrack 60x216

RECTANGLE ARC ENDS		
Size / Shape	Number of Tabletop Sections	Number of Chairs (based on 25" wide chairs)
48 x 96REA	1	8
48 x 120REA	2	10
48 x 144REA	2	10
48 x 168REA	2	12
48 x 192REA	2	14
48 x 216REA	2	14
60 x 120REA	2	10
60 x 144REA	2	12
60 x 168REA	2	12
60 x 192REA	2	14
60 x 216REA	2	16

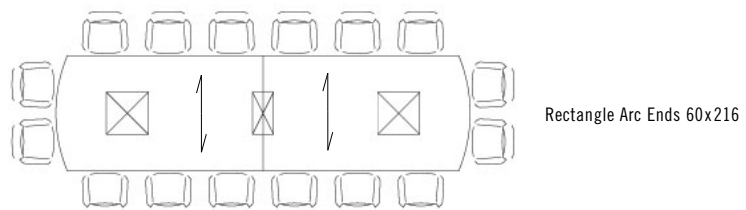

Rectangle Arc Ends 60x216

BOARDGAMES TABLES

TABLETOP SECTIONS AND SEATING LAYOUTS

BOATSHAPE		
Size / Shape	Number of Tabletop Sections	Number of Chairs (based on 25" wide chairs)
48 x 96BT	1	8
48 x 120BT	2	10
48 x 144BT	2	10
48 x 168BT	2	12
48 x 192BT	2	14
48 x 216BT	2	14
60 x 120BT	2	10
60 x 144BT	2	12
60 x 168BT	2	12
60 x 192BT	2	14
60 x 216BT	2	16
Standard with 12" Taper		



BOATSHAPE ARC ENDS		
Size / Shape	Number of Tabletop Sections	Number of Chairs (based on 25" wide chairs)
48 x 96BTA	1	8
48 x 120BTA	2	10
48 x 144BTA	2	10
48 x 168BTA	2	12
48 x 192BTA	2	14
48 x 216BTA	2	14
60 x 120BTA	2	10
60 x 144BTA	2	12
60 x 168BTA	2	12
60 x 192BTA	2	14
60 x 216BTA	2	16

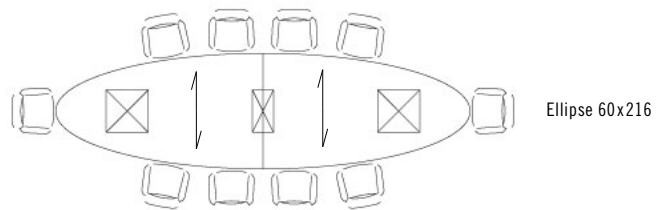
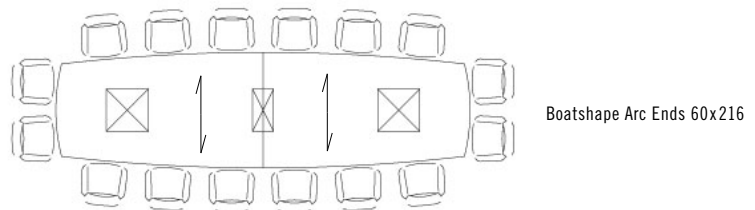
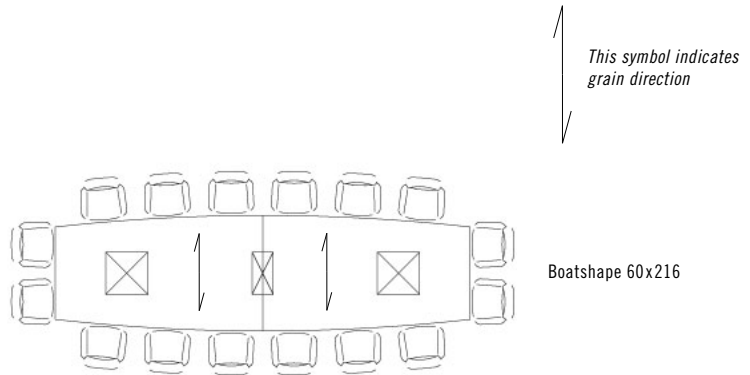

ELLIPSE		
Size / Shape	Number of Tabletop Sections	Number of Chairs (based on 25" wide chairs)
48 x 96EL	1	6
48 x 120EL	2	6
48 x 144EL	2	8
48 x 168EL	2	10
48 x 192EL	2	10
48 x 216EL	2	12
60 x 120EL	2	8
60 x 144EL	2	10
60 x 168EL	2	10
60 x 192EL	2	12
60 x 216EL	2	14



BOARDGAMES TABLES

TABLETOP SECTIONS AND SEATING LAYOUTS

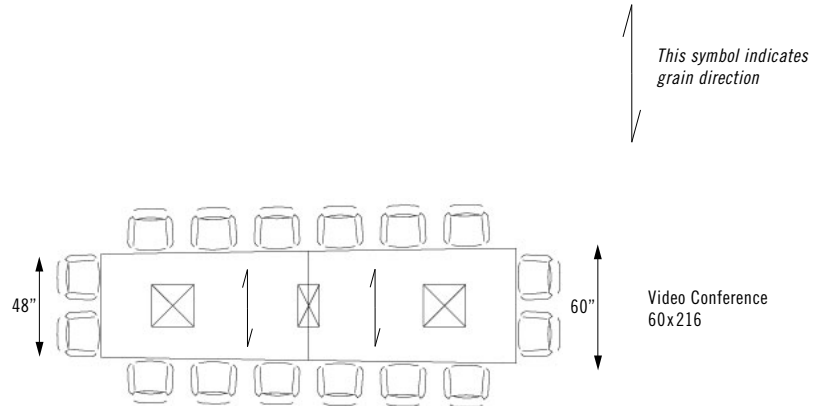
VIDEO CONFERENCE		
Size / Shape	Number of Tabletop Sections	Number of Chairs (based on 25" wide chairs)
48 x 96VC	1	4
48 x 120VC	2	6
48 x 144VC	2	6
48 x 168VC	2	8
48 x 192VC	2	10
48 x 216VC	2	10
60 x 120VC	2	6
60 x 144VC	2	6
60 x 168VC	2	8
60 x 192VC	2	14
60 x 216VC	2	16
Standard with 12" Taper		

VIDEO CONFERENCE ARC		
Size / Shape	Number of Tabletop Sections	Number of Chairs (based on 25" wide chairs)
48 x 96VCA	1	4
48 x 120VCA	2	6
48 x 144VCA	2	6
48 x 168VCA	2	8
48 x 192VCA	2	10
48 x 216VCA	2	10
60 x 120VCA	2	6
60 x 144VCA	2	6
60 x 168VCA	2	8
60 x 192VCA	2	14
60 x 216VCA	2	16
Standard with 12" Taper		

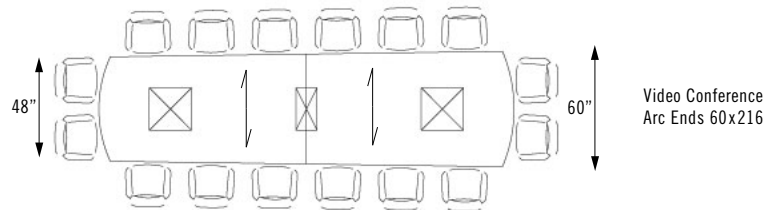

LARGER TABLE SIZES

Boardgames tabletops with a length of 108" to 216" and a width that doesn't exceeds 60", will be made in 2 equal pieces. Boardgames tabletops with a length of 216" to 324" and a width that doesn't exceed 60", will be made in 3 equal pieces. All multiple piece tabletops are tight joint fastened. Bases standard in 22" width. 30" width available. Please contact factory for pricing.

WOOD FINISHES AND GRAIN DIRECTION

Finishes

Veneers and hardwood edge finishes are available in our 9 standard stains or stain-to-match which is never an upcharge.

Grain Direction

The grain on a single piece boardroom tabletop will run lengthwise. The grain on a 2 piece or more top runs from side to side, signified on line drawing with grain direction symbol.  Laminates with wood grain patterns follow the same direction as veneer wood grains.

BOARDGAMES TABLES

POWER AND VOICE/DATA MODULES

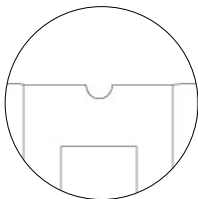
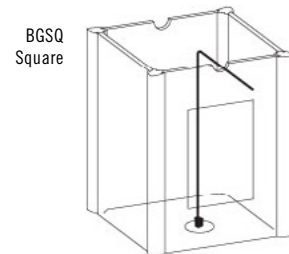
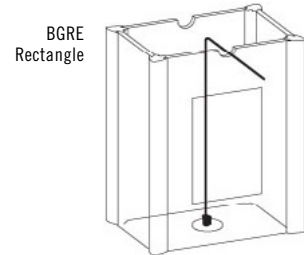
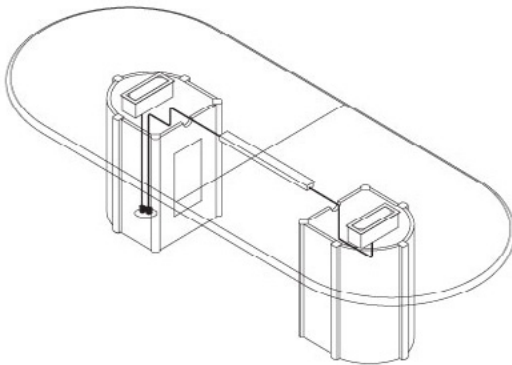
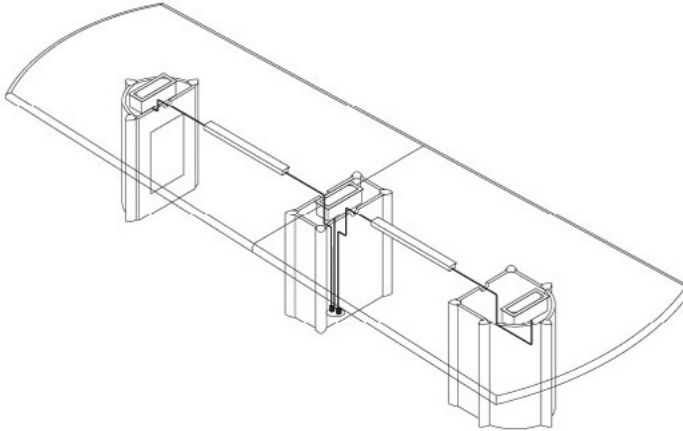
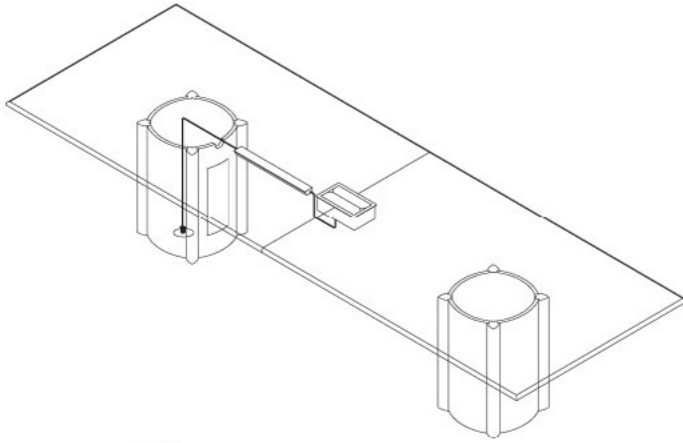

All Boardgames bases are standard with a touch latch removable door and a 3" cutout for wire pass-through at the top

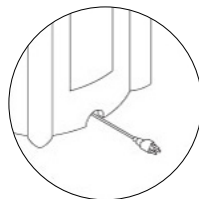

Optional cutout for wire pass-through at the bottom of Boardgames bases must be specified if required

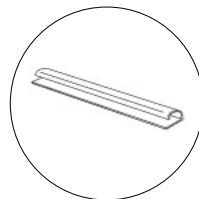

Tops are standard with 24" PVC under table wire manager between bases