



Pricing March 1, 2019
Discount 57.7% from List prices



SIN 711-11

BOARDGAMES TABLES



PRODUCT CODE

4896 RE BG DR - L

Top Size

Width x Length

Top Shape

D : Round
SQ : Square
RE : Rectangle
REA: Rectangle Arc
RT : Racetrack
BT : Boatshape
BTA : Boatshape Arc

EL : Ellipse
VC : Video
Conference
VCA : Video
Conference Arc

Series

BG : Boardgame
PL : Plinth

Base Shape

DR : Drum
RE : Rectangle
SQ : Square
EL : Ellipse
DDR : D-Drum
HDR : Half Drum

Finish

L : Laminate
V : Veneer



OPTIONS

BASE

Drum



Ellipse



Half Drum



D Drum



Rectangle



Square



TRIM DETAIL

Aluminum



Wood



Plinth Rectangle



Plinth Square



Plinth Drum



FINISHES

LAMINATE

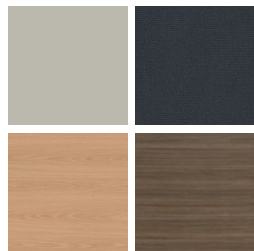

Select from 15 standard laminates or choose any standard Wilsonart, Nevamar, Formica, Arborite and Pionite matte finish laminates at no upcharge

VENEER



Select from one of our 9 standard wood stains or stain-to-match at no upcharge

ALUMINUM BASE TRIM



Select from one of our 76 standard Spectone colors

EDGE

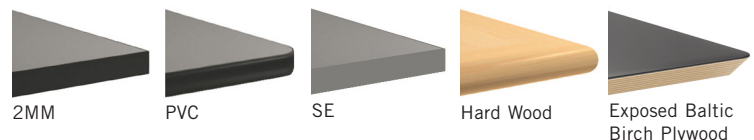

See Spectone Card or specfurniture.com/materials/finishes for a complete list of finish options and colors.



BOARDGAMES TABLES

HOW TO ORDER

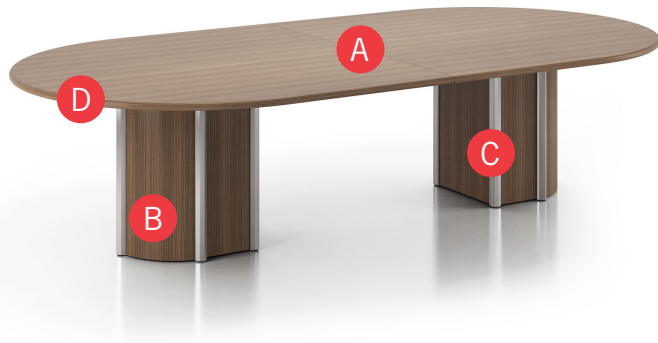

Specify Top Size (Width x Length) and Shape

- A** Specify Top Type and Finish
For Laminate Top: Manufacturer, Laminate Name, Laminate Code
For Veneer Top: Wood Stain
- B** Specify Edge Type, (for hardwood: Style), and Finish
PVC/2mm/Self Edge/Exposed Baltic Birch Plywood/Hardwood
- C** Specify Base Type and Finish
For Laminate Base: Manufacturer, Laminate Name, Laminate Code
For Veneer Base: Wood Stain
- D** Specify Base Trim Type and Finish
For Aluminum: RAL Color
For Wood: Wood Stain

Optional: Grommets, Power and Data Modules, Custom Solutions



Top Size and Shape	Top Type and Finish	Edge Type and Finish	Base Type and Finish	Base Trim Type and Finish
24 x 72, Racetrack	Laminate, Arborite, Brown Sugar	Hardwood, HF, Custom Brown Sugar Stain	Laminate, Arborite, Brown Sugar	Aluminum, Silver



Pricing March 1, 2019
Discount 57.7% from List prices



SIN 711-11

BOARDGAMES TABLES BOARDROOM

TABLETOP SHAPES

On one piece tabletops, grain direction runs lengthwise.

On tabletops of two or more pieces, grain direction runs from side to side, as standard.

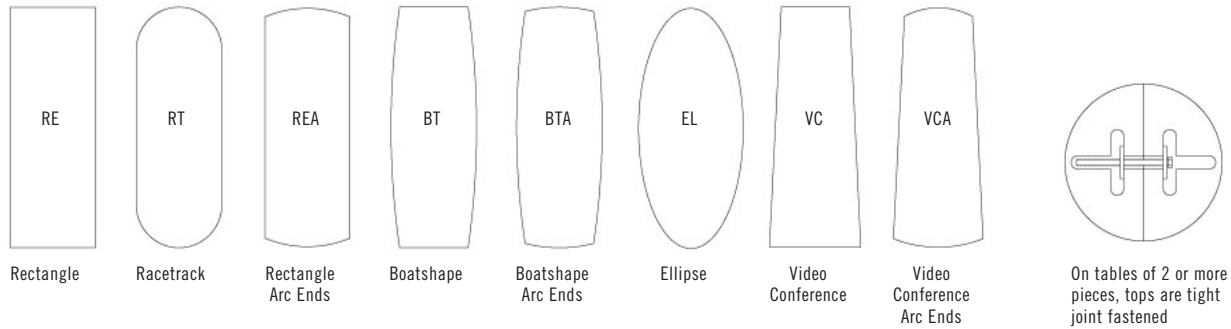

EDGE PROFILES

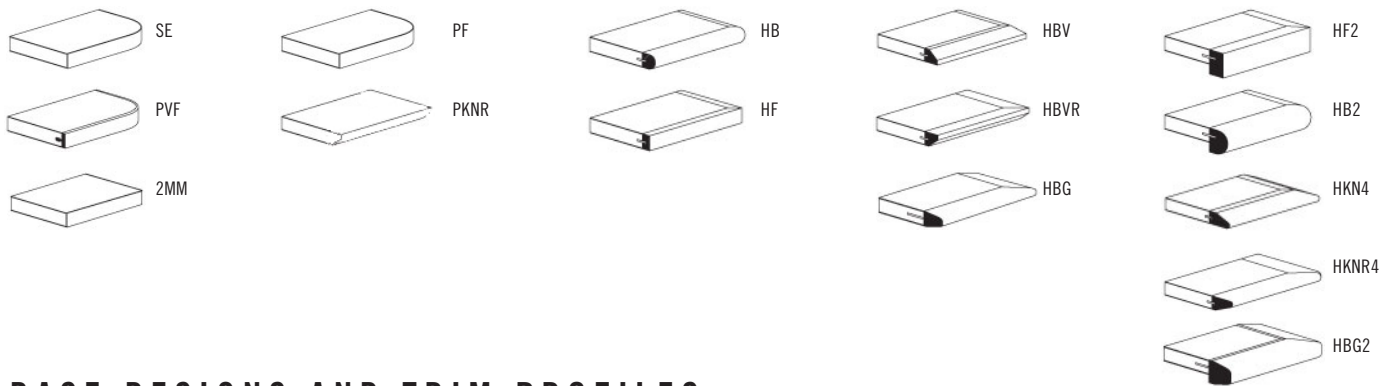

BASE DESIGNS AND TRIM PROFILES

Boardgames - Base Designs

Six different Boardgames bases are available, in laminate or veneer, standard at 22" width. For 30" width options, please contact Spec Customer Service. Each base features trim profiles in your choice of aluminum extrusion or wood. Aluminum extrusion is available in any Spectone color at no upcharge.

Wood trim on base stained in any of Spec's 9 standard stain colors or stain-to-match at no upcharge. The bases are standard with a removable door for wire access and a cutout at the top for wire pass-through.

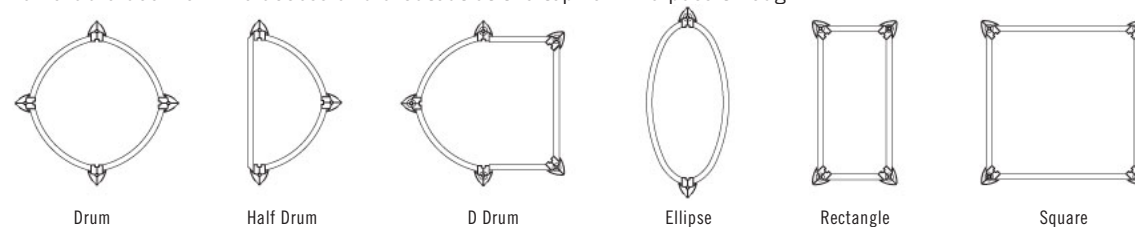

Boardgames - Base Trim Profiles

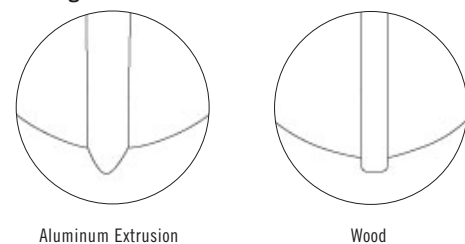



Pricing March 1, 2019
Discount 57.7% from List prices



SIN 711-11



BOARDGAMES TABLES BOARDROOM TABLETOP



MODEL	TABLETOPS		TOP AND EDGE SPECIFICATIONS						BASES	LBS
	Code	Number of Sections	For Laminate Top			For Veneer Top				
			SE PVF 2MM	HF HB	HBV HBVR HBG	HF2 HB2 HKN4 HKNR4 HBG2	HF HB HBV HBVR HBG	HF2 HB2 HKN4 HKNR4 HBG2	BGDR BGSQ PLDR PLSQ	
<i>Round</i>										
42	42D	1	641	1195	1314	1569	1594	1895	1	110
48	48D	1	663	1407	1537	1663	2119	2506	1	126
54	54D	1	942	2038	2240	2433	2660	3156	1	146
60	60D	1	988	2233	2448	2611	3270	3887	1	165



BASES

MODEL	BASE SHAPES	FINISH	BASE PRICE	LBS
		<i>Aluminum or Wood Trim</i>		
BGDR-L	 BOARDGAME DRUM	Laminate	1422	75
BGDR-V	 BOARDGAME DRUM	Veneer	1590	75
BGSQ-L	 BOARDGAME SQUARE	Laminate	939	70
BGSQ-V	 BOARDGAME SQUARE	Veneer	1107	70
PLDR-L	 PLINTH BASE DRUM	Laminate	1422	75
PLDR-V	 PLINTH BASE DRUM	Veneer	1590	75
PLSQ-L	 PLINTH BASE SQUARE	Laminate	939	70
PLSQ-V	 PLINTH BASE SQUARE	Veneer	1107	70

*Bases standard in 22" width. 30" width available, please contact factory for pricing.



BGDR



BGSQ



PLSQ



PLDR

For applicable Power & Data modules, please see Table Accessories Price List.

Toll Free: 1-888-761-7732



Pricing March 1, 2019
Discount 57.7% from List prices



SIN 711-11

BOARDGAMES TABLES

BOARDROOM

TABLETOP











MODEL	TABLETOPS		TOP AND EDGE SPECIFICATIONS						BASES		LBS
	Code	Number of Sections	For Laminate Top			For Veneer Top			Number of Bases Required		
			SE PVF 2MM	HF HB PKNR ¹ PF ¹	HBV HBVR HBG	HF2 HB2 HKN4 HKNR4 HBG2	HF HB HBV HBVR HBG	HF2 HB2 HKN4 HKNR4 HBG2	BGDR BGSQ PLDR PLSQ		
<i>Square</i>											
36 x 36	36SQ	1	385	599	659	861	868	1061	1	98	
42 x 42	42SQ	1	655	965	1061	1157	1223	1486	1	112	
48 x 48	48SQ	1	803	1075	1176	1221	1585	1924	1	128	
54 x 54	54SQ	1	945	1545	1703	1886	1986	2425	1	146	
60 x 60	60SQ	1	974	1647	1815	1999	2446	2978	1	165	

¹ Exposed Baltic Birch plywood edge (PKNR, PF) can only be specified on tops up to 47-1/2" x 95-1/2". Clear finish only.



BASES

MODEL	BASE SHAPES	FINISH	BASE PRICE	LBS
		<i>Aluminum or Wood Trim</i>		
BGDR-L	 BOARDGAME DRUM	Laminate	1422	75
BGDR-V	 BOARDGAME DRUM	Veneer	1590	75
BGSQ-L	 BOARDGAME SQUARE	Laminate	939	70
BGSQ-V	 BOARDGAME SQUARE	Veneer	1107	70
PLDR-L	 PLINTH BASE DRUM	Laminate	1422	75
PLDR-V	 PLINTH BASE DRUM	Veneer	1590	75
PLSQ-L	 PLINTH BASE SQUARE	Laminate	939	70
PLSQ-V	 PLINTH BASE SQUARE	Veneer	1107	70

*Bases standard in 22" width. 30" width available, please contact factory for pricing.



BGDR



BGSQ



PLSQ



PLDR

For applicable Power & Data modules, please see Table Accessories Price List.

Toll Free: 1-888-761-7732



Pricing March 1, 2019
Discount 57.7% from List prices



SIN 711-11

BOARDGAMES TABLES

BOARDROOM

TABLETOP



MODEL	TABLETOPS		TOP AND EDGE SPECIFICATIONS						BASES		LBS
	Code	Number of Sections	For Laminate Top			For Veneer Top			Number of Bases Required		
			SE PVF 2MM	HF HB PKNR ¹ PF ¹	HBV HBVR HBG	HF2 HB2 HKN4 HKNR4 HBG2	HF HB HBV HBVR HBG	HF2 HB2 HKN4 HKNR4 HBG2	BGEL BGRE BGHDR*	BGDR BGSQ BGDDR*	
<i>Rectangle</i>											
48 x 96	4896RE	1	1364	2239	2476	2715	3069	3754	2	2	135
48 x 120	48120RE	2	1689	2819	3087	3664	3749	4550	3	2	168
48 x 144	48144RE	2	2070	3690	4043	4592	4462	5425	3	3	202
48 x 168	48168RE	2	2555	4186	4588	5355	5178	6297	3	3	236
48 x 192	48192RE	2	2865	4989	5478	6571	6198	7537	3	3	269
48 x 216	48216RE	2	3459	5562	6100	7263	6909	8418	3	3	303
60 x 120	60120RE	2	2155	3844	4213	4783	4647	5652	3	2	210
60 x 144	60144RE	2	2586	4613	5055	5738	5577	6782	3	3	252
60 x 168	60168RE	2	3018	5383	5896	6696	6507	7911	3	3	294
60 x 192	60192RE	2	3625	6460	7074	8034	7808	9494	3	3	336
60 x 216	60216RE	2	4076	7267	7962	9038	8784	10678	3	3	378

*When specifying Half Drum (BGHDR) or D-Drum (BGDDR) bases where 3 bases are required, the middle base should be specified as a Rectangle base (BGRE).
¹ Exposed Baltic Birch plywood edge (PKNR, PF) can only be specified on tops up to 47-1/2" x 95-1/2". Clear finish only.

BASES

MODEL	BASE SHAPES	FINISH	BASE PRICE	LBS	
		<i>Aluminum or Wood Trim</i>			
BGDR-L		BOARDGAME DRUM	Laminate	1422	75
BGDR-V			Veneer	1590	75
BGRE-L		BOARDGAME RECTANGLE	Laminate	939	70
BGRE-V			Veneer	1107	70
BGSQ-L		BOARDGAME SQUARE	Laminate	939	70
BGSQ-V			Veneer	1107	70
BGEL-L		BOARDGAME ELLIPSE	Laminate	1006	65
BGEL-V			Veneer	1177	65
BGDDR-L		BOARDGAME D-DRUM	Laminate	1587	85
BGDDR-V			Veneer	1760	85
BGHDR-L		BOARDGAME HALF DRUM	Laminate	1145	65
BGHDR-V			Veneer	1315	65
PLDR-L		PLINTH BASE DRUM	Laminate	1422	75
PLDR-V			Veneer	1590	75
PLSQ-L		PLINTH BASE SQUARE	Laminate	939	70
PLSQ-V			Veneer	1107	70
PLRE-L		PLINTH BASE RECTANGLE	Laminate	939	70
PLRE-V			Veneer	1107	70

*Bases standard in 22" width. 30" width available, please contact factory for pricing.



For applicable Power & Data modules, please see Table Accessories Price List.

Toll Free: 1-888-761-7732



Pricing March 1, 2019
Discount 57.7% from List prices



SIN 711-11

BOARDGAMES TABLES

BOARDROOM

TABLETOP



MODEL	TABLETOPS		TOP AND EDGE SPECIFICATIONS						BASES		LBS
	Code	Number of Sections	For Laminate Top			For Veneer Top			Number of Bases Required		
			SE PVF 2MM	HF HB	HBV HBVR HBG	HF2 HB2 HKN4 HKNR4 HBG2	HF HB HBV HBVR HBG	HF2 HB2 HKN4 HKNR4 HBG2	BGEL BGRE BGHDR*	BGDR BGSQ BGDDR*	
<i>Rectangle Arc Ends</i>											
48 x 96	4896REA	1	1384	2373	2614	3194	3604	4334	2	2	135
48 x 120	48120REA	2	1715	3285	3599	4398	4364	5217	3	2	168
48 x 144	48144REA	2	2099	4054	4439	5430	5200	6235	3	3	202
48 x 168	48168REA	2	2586	4712	5162	6262	6048	7247	3	3	236
48 x 192	48192REA	2	2767	5542	6078	7138	7421	8262	3	3	269
48 x 216	48216REA	2	3459	6215	6819	8133	8457	9274	3	3	303
60 x 120	60120REA	2	2144	4106	4496	5500	5455	6525	3	2	210
60 x 144	60144REA	2	2624	5067	5551	6791	6502	7794	3	3	252
60 x 168	60168REA	2	3235	5893	6455	7826	7561	9059	3	3	294
60 x 192	60192REA	2	3880	7071	7747	9392	9769	10872	3	3	336
60 x 216	60216REA	2	4365	7954	8714	10566	10989	12230	3	3	378

*When specifying Half Drum (BGHDR) or D-Drum (BGDDR) bases where 3 bases are required, the middle base should be specified as a Rectangle base (BGRE).

BASES

MODEL	BASE SHAPES	FINISH	BASE PRICE	LBS	
		<i>Aluminum or Wood Trim</i>			
BGDR-L		BOARDGAME DRUM	Laminate	1422	75
BGDR-V			Veneer	1590	75
BGRE-L		BOARDGAME RECTANGLE	Laminate	939	70
BGRE-V			Veneer	1107	70
BGSQ-L		BOARDGAME SQUARE	Laminate	939	70
BGSQ-V			Veneer	1107	70
BGEL-L		BOARDGAME ELLIPSE	Laminate	1006	65
BGEL-V			Veneer	1177	65
BGDDR-L		BOARDGAME D-DRUM	Laminate	1587	85
BGDDR-V			Veneer	1760	85
BGHDR-L		BOARDGAME HALF DRUM	Laminate	1145	65
BGHDR-V			Veneer	1315	65
PLDR-L		PLINTH BASE DRUM	Laminate	1422	75
PLDR-V			Veneer	1590	75
PLSQ-L		PLINTH BASE SQUARE	Laminate	939	70
PLSQ-V			Veneer	1107	70
PLRE-L		PLINTH BASE RECTANGLE	Laminate	939	70
PLRE-V			Veneer	1107	70

*Bases standard in 22" width. 30" width available, please contact factory for pricing.



For applicable Power & Data modules, please see Table Accessories Price List.

Toll Free: 1-888-761-7732



Pricing March 1, 2019
Discount 57.7% from List prices



SIN 711-11

BOARDGAMES TABLES BOARDROOM TABLETOP



MODEL	TABLETOPS		TOP AND EDGE SPECIFICATIONS						BASES		LBS
	Code	Number of Sections	For Laminate Top			For Veneer Top			Number of Bases Required		
			SE PVF 2MM	HF HB	HBV HBV HBG	HF2 HB2 HKN4 HKNR4 HBG2	HF HB HBV HBVR HBG	HF2 HB2 HKN4 HKNR4 HBG2	BGEL BGRE BGHDR*	BGDR BGSQ BGDDR* PLDR PLSQ	
<i>Racetrack</i>											
48 x 96	4896RT	1	1384	2373	2614	3194	3604	4334	2	2	135
48 x 120	48120RT	2	1715	3285	3599	4398	4364	5217	3	2	168
48 x 144	48144RT	2	2099	4054	4439	5430	5200	6235	3	3	202
48 x 168	48168RT	2	2586	4712	5162	6262	6048	7247	3	3	236
48 x 192	48192RT	2	2767	5542	6078	7138	7421	8262	3	3	269
48 x 216	48216RT	2	3459	6215	6819	8133	8457	9274	3	3	303
60 x 120	60120RT	2	2144	4106	4496	5500	5455	6525	3	2	210
60 x 144	60144RT	2	2624	5067	5551	6791	6502	7794	3	3	252
60 x 168	60168RT	2	3235	5893	6455	7826	7561	9059	3	3	294
60 x 192	60192RT	2	3880	7071	7747	9392	9769	10872	3	3	336
60 x 216	60216RT	2	4365	7954	8714	10566	10989	12230	3	3	378

*When specifying Half Drum (BGHDR) or D-Drum (BGDDR) bases where 3 bases are required, the middle base should be specified as a Rectangle base (BGRE).

BASES

MODEL	BASE SHAPES	FINISH	BASE PRICE	LBS	
		<i>Aluminum or Wood Trim</i>			
BGDR-L		BOARDGAME DRUM	Laminate	1422	75
BGDR-V			Veneer	1590	75
BGRE-L		BOARDGAME RECTANGLE	Laminate	939	70
BGRE-V			Veneer	1107	70
BGSQ-L		BOARDGAME SQUARE	Laminate	939	70
BGSQ-V			Veneer	1107	70
BGEL-L		BOARDGAME ELLIPSE	Laminate	1006	65
BGEL-V			Veneer	1177	65
BGDDR-L		BOARDGAME D-DRUM	Laminate	1587	85
BGDDR-V			Veneer	1760	85
BGHDR-L		BOARDGAME HALF DRUM	Laminate	1145	65
BGHDR-V			Veneer	1315	65
PLDR-L		PLINTH BASE DRUM	Laminate	1422	75
PLDR-V			Veneer	1590	75
PLSQ-L		PLINTH BASE SQUARE	Laminate	939	70
PLSQ-V			Veneer	1107	70
PLRE-L		PLINTH BASE RECTANGLE	Laminate	939	70
PLRE-V			Veneer	1107	70

*Bases standard in 22" width. 30" width available, please contact factory for pricing.



For applicable Power & Data modules, please see Table Accessories Price List.

Toll Free: 1-888-761-7732



Pricing March 1, 2019
Discount 57.7% from List prices



SIN 711-11

BOARDGAMES TABLES BOARDROOM TABLETOP



MODEL	TABLETOPS		TOP AND EDGE SPECIFICATIONS						BASES		LBS
	Code	Number of Sections	For Laminate Top			For Veneer Top			Number of Bases Required		
			SE PVF 2MM	HF HB	HBV HBVR HBG	HF2 HB2 HKN4 HKNR4 HBG2	HF HB HBV HBVR HBG	HF2 HB2 HKN4 HKNR4 HBG2	BGEL BGRE BGHDR*	BGDR BGSQ BGDDR* PLDR PLSQ	
<i>Boatshape</i>											
48 x 96	4896BT	1	1384	3048	3358	3677	4130	4528	2	2	135
48 x 120	48120BT	2	1715	4024	4408	4813	4986	5446	3	2	168
48 x 144	48144BT	2	2099	4794	5252	5738	6352	6770	3	3	202
48 x 168	48168BT	2	2586	5530	6063	6625	6912	7558	3	3	236
48 x 192	48192BT	2	2767	6377	6991	8207	8534	9501	3	3	269
48 x 216	48216BT	2	3459	7146	7839	9352	9726	10664	3	3	303
60 x 120	60120BT	2	2144	5028	5512	6017	6235	6806	3	2	210
60 x 144	60144BT	2	2624	5994	6566	7175	7939	8464	3	3	252
60 x 168	60168BT	2	3235	6915	7580	8283	8638	9448	3	3	294
60 x 192	60192BT	2	3880	8297	9095	9940	10366	11337	3	3	336
60 x 216	60216BT	2	4365	9334	10234	11183	11662	12756	3	3	378

*When specifying Half Drum (BGHDR) or D-Drum (BGDDR) bases where 3 bases are required, the middle base should be specified as a Rectangle base (BGRE).

BASES

MODEL	BASE SHAPES	FINISH	BASE PRICE	LBS	
		<i>Aluminum or Wood Trim</i>			
BGDR-L		BOARDGAME DRUM	Laminate	1422	75
BGDR-V			Veneer	1590	75
BGRE-L		BOARDGAME RECTANGLE	Laminate	939	70
BGRE-V			Veneer	1107	70
BGSQ-L		BOARDGAME SQUARE	Laminate	939	70
BGSQ-V			Veneer	1107	70
BGEL-L		BOARDGAME ELLIPSE	Laminate	1006	65
BGEL-V			Veneer	1177	65
BGDDR-L		BOARDGAME D-DRUM	Laminate	1587	85
BGDDR-V			Veneer	1760	85
BGHDR-L		BOARDGAME HALF DRUM	Laminate	1145	65
BGHDR-V			Veneer	1315	65
PLDR-L		PLINTH BASE DRUM	Laminate	1422	75
PLDR-V			Veneer	1590	75
PLSQ-L		PLINTH BASE SQUARE	Laminate	939	70
PLSQ-V			Veneer	1107	70
PLRE-L		PLINTH BASE RECTANGLE	Laminate	939	70
PLRE-V			Veneer	1107	70

*Bases standard in 22" width. 30" width available, please contact factory for pricing.



For applicable Power & Data modules, please see Table Accessories Price List.

Toll Free: 1-888-761-7732



Pricing March 1, 2019
Discount 57.7% from List prices



SIN 711-11

BOARDGAMES TABLES BOARDROOM TABLETOP

MODEL	TABLETOPS		TOP AND EDGE SPECIFICATIONS						BASES		LBS
	Code	Number of Sections	For Laminate Top			For Veneer Top			Number of Bases Required		
			SE PVF 2MM	HF HB	HBV HBVR HBG	HF2 HB2 HKN4 HKNR4 HBG2	HF HB HBV HBVR HBG	HF2 HB2 HKN4 HKNR4 HBG2	BGEL BGRE BGHDR*	BGDR BGSQ BGDDR*	
<i>Boatshape Arc Ends</i>											
48 x 96	4896BTA	1	1553	3578	3889	4211	4661	5059	2	2	135
48 x 120	48120BTA	2	1884	4557	4941	5347	5519	5976	3	2	168
48 x 144	48144BTA	2	2268	5324	5786	6272	6882	7303	3	3	202
48 x 168	48168BTA	2	2756	6063	6597	7159	7443	8092	3	3	236
48 x 192	48192BTA	2	3044	7014	7689	9029	9389	10451	3	3	269
48 x 216	48216BTA	2	3803	7863	8625	10287	10700	11732	3	3	303
60 x 120	60120BTA	2	2357	5696	6176	6683	6898	7470	3	2	210
60 x 144	60144BTA	2	2835	6657	7233	7839	8605	9127	3	3	252
60 x 168	60168BTA	2	3445	7580	8245	8946	9305	10116	3	3	294
60 x 192	60192BTA	2	4135	9095	9894	10734	11165	12139	3	3	336
60 x 216	60216BTA	2	4654	10234	11132	12077	12560	13655	3	3	378

*When specifying Half Drum (BGHDR) or D-Drum (BGDDR) bases where 3 bases are required, the middle base should be specified as a Rectangle base (BGRE).

BASES

MODEL	BASE SHAPES	FINISH	BASE PRICE	LBS	
		<i>Aluminum or Wood Trim</i>			
BGDR-L		BOARDGAME DRUM	Laminate	1422	75
BGDR-V			Veneer	1590	75
BGRE-L		BOARDGAME RECTANGLE	Laminate	939	70
BGRE-V			Veneer	1107	70
BGSQ-L		BOARDGAME SQUARE	Laminate	939	70
BGSQ-V			Veneer	1107	70
BGEL-L		BOARDGAME ELLIPSE	Laminate	1006	65
BGEL-V			Veneer	1177	65
BGDDR-L		BOARDGAME D-DRUM	Laminate	1587	85
BGDDR-V			Veneer	1760	85
BGHDR-L		BOARDGAME HALF DRUM	Laminate	1145	65
BGHDR-V			Veneer	1315	65
PLDR-L		PLINTH BASE DRUM	Laminate	1422	75
PLDR-V			Veneer	1590	75
PLSQ-L		PLINTH BASE SQUARE	Laminate	939	70
PLSQ-V			Veneer	1107	70
PLRE-L		PLINTH BASE RECTANGLE	Laminate	939	70
PLRE-V			Veneer	1107	70

*Bases standard in 22" width. 30" width available, please contact factory for pricing.



For applicable Power & Data modules, please see Table Accessories Price List.

Toll Free: 1-888-761-7732



Pricing March 1, 2019
Discount 57.7% from List prices



SIN 711-11

BOARDGAMES TABLES BOARDROOM TABLETOP

MODEL	TABLETOPS		TOP AND EDGE SPECIFICATIONS						BASES		LBS
	Code	Number of Sections	For Laminate Top			For Veneer Top			Number of Bases Required		
			SE PVF 2MM	HF HB	HBV HBVR HBG	HF2 HB2 HKN4 HKNR4 HBG2	HF HB HBV HBVR HBG	HF2 HB2 HKN4 HKNR4 HBG2	BGEL BGRE BGHDR*	BGDR BGSQ BGDDR* PLDR PLSQ	
<i>Ellipse</i>											
48 x 96	4896EL	1	1661	3657	4029	4414	4954	5431	2	2	135
48 x 120	48120EL	2	2059	4829	5291	5776	5985	6532	3	2	168
48 x 144	48144EL	2	2518	5753	6303	6888	7622	8126	3	3	202
48 x 168	48168EL	2	3105	6636	7277	7950	8267	9071	3	3	236
48 x 192	48192EL	2	3346	7716	8458	9930	10329	11497	3	3	269
48 x 216	48216EL	2	4184	8649	9487	11315	11768	12905	3	3	303
60 x 120	60120EL	2	2711	6551	7102	7685	7933	8590	3	2	210
60 x 144	60144EL	2	3260	7655	8316	9017	9894	10497	3	3	252
60 x 168	60168EL	2	3962	8718	9483	10289	10702	11632	3	3	294
60 x 192	60192EL	2	4757	10459	11378	12345	12840	13960	3	3	336
60 x 216	60216EL	2	5352	11768	12802	13887	14445	15702	3	3	378

*When specifying Half Drum (BGHDR) or D-Drum (BGDDR) bases where 3 bases are required, the middle base should be specified as a Rectangle base (BGRE).

BASES

MODEL	BASE SHAPES	FINISH	BASE PRICE	LBS	
		<i>Aluminum or Wood Trim</i>			
BGDR-L		BOARDGAME DRUM	Laminate	1422	75
BGDR-V			Veneer	1590	75
BGRE-L		BOARDGAME RECTANGLE	Laminate	939	70
BGRE-V			Veneer	1107	70
BGSQ-L		BOARDGAME SQUARE	Laminate	939	70
BGSQ-V			Veneer	1107	70
BGEL-L		BOARDGAME ELLIPSE	Laminate	1006	65
BGEL-V			Veneer	1177	65
BGDDR-L		BOARDGAME D-DRUM	Laminate	1587	85
BGDDR-V			Veneer	1760	85
BGHDR-L		BOARDGAME HALF DRUM	Laminate	1145	65
BGHDR-V			Veneer	1315	65
PLDR-L		PLINTH BASE DRUM	Laminate	1422	75
PLDR-V			Veneer	1590	75
PLSQ-L		PLINTH BASE SQUARE	Laminate	939	70
PLSQ-V			Veneer	1107	70
PLRE-L		PLINTH BASE RECTANGLE	Laminate	939	70
PLRE-V			Veneer	1107	70

*Bases standard in 22" width. 30" width available, please contact factory for pricing.



For applicable Power & Data modules, please see Table Accessories Price List.

Toll Free: 1-888-761-7732



Pricing March 1, 2019
Discount 57.7% from List prices



SIN 711-11

BOARDGAMES TABLES

BOARDROOM

TABLETOP

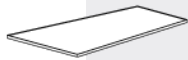

MODEL	TABLETOPS		TOP AND EDGE SPECIFICATIONS						BASES		LBS
	Code	Number of Sections	For Laminate Top			For Veneer Top			Number of Bases Required		
			SE PVF 2MM	HF HB	HBV HBVR HBG	HF2 HB2 HKN4 HKNR4 HBG2	HF HB HBV HBVR HBG	HF2 HB2 HKN4 HKNR4 HBG2	BGEL BGRE BGHDR*	BGDR BGSQ BGDDR*	
<i>Video Conference</i>											
48 x 96	4896VC	1	1384	3048	3358	3677	4130	4528	2	2	135
48 x 120	48120VC	2	1715	4024	4408	4813	4986	5446	3	2	168
48 x 144	48144VC	2	2099	4794	5252	5738	6352	6770	3	3	202
48 x 168	48168VC	2	2586	5530	6063	6625	6891	7558	3	3	236
48 x 192	48192VC	2	2767	6377	6991	8207	8534	9501	3	3	269
48 x 216	48216VC	2	3459	7146	7839	9352	9726	10664	3	3	303
60 x 120	60120VC	2	2144	5028	5512	6017	6235	6806	3	2	210
60 x 144	60144VC	2	2624	5994	6566	7175	7939	8464	3	3	252
60 x 168	60168VC	2	3235	6915	7580	8283	8638	9448	3	3	294
60 x 192	60192VC	2	3880	8297	9095	9940	10366	11337	3	3	336
60 x 216	60216VC	2	4365	9334	10234	11183	11662	12756	3	3	378

*When specifying Half Drum (BGHDR) or D-Drum (BGDDR) bases where 3 bases are required, the middle base should be specified as a Rectangle base (BGRE).

BASES

MODEL	BASE SHAPES	FINISH	BASE PRICE	LBS	
		<i>Aluminum or Wood Trim</i>			
BGDR-L		BOARDGAME DRUM	Laminate	1422	75
BGDR-V		BOARDGAME DRUM	Veneer	1590	75
BGRE-L		BOARDGAME RECTANGLE	Laminate	939	70
BGRE-V		BOARDGAME RECTANGLE	Veneer	1107	70
BGSQ-L		BOARDGAME SQUARE	Laminate	939	70
BGSQ-V		BOARDGAME SQUARE	Veneer	1107	70
BGEL-L		BOARDGAME ELLIPSE	Laminate	1006	65
BGEL-V		BOARDGAME ELLIPSE	Veneer	1177	65
BGDDR-L		BOARDGAME D-DRUM	Laminate	1587	85
BGDDR-V		BOARDGAME D-DRUM	Veneer	1760	85
BGHDR-L		BOARDGAME HALF DRUM	Laminate	1145	65
BGHDR-V		BOARDGAME HALF DRUM	Veneer	1315	65
PLDR-L		PLINTH BASE DRUM	Laminate	1422	75
PLDR-V		PLINTH BASE DRUM	Veneer	1590	75
PLSQ-L		PLINTH BASE SQUARE	Laminate	939	70
PLSQ-V		PLINTH BASE SQUARE	Veneer	1107	70
PLRE-L		PLINTH BASE RECTANGLE	Laminate	939	70
PLRE-V		PLINTH BASE RECTANGLE	Veneer	1107	70

*Bases standard in 22" width. 30" width available, please contact factory for pricing.



For applicable Power & Data modules, please see Table Accessories Price List.

Toll Free: 1-888-761-7732



Pricing March 1, 2019
Discount 57.7% from List prices



SIN 711-11

BOARDGAMES TABLES BOARDROOM TABLETOP



MODEL	TABLETOPS		TOP AND EDGE SPECIFICATIONS						BASES		LBS
	Code	Number of Sections	For Laminate Top			For Veneer Top			Number of Bases Required		
			SE PVF 2MM	HF HB	HBV HBVR HBG	HF2 HB2 HKN4 HKNR4 HBG2	HF HB HBV HBVR HBG	HF2 HB2 HKN4 HKNR4 HBG2	BGEL BGRE BGHDR*	BGDR BGSQ BGDDR* PLDR PLSQ	
<i>Video Conference Arc Ends</i>											
48 x 96	4896VCA	1	1553	3578	3889	4211	4661	5059	2	2	135
48 x 120	48120VCA	2	1884	4557	4941	5347	5519	5976	3	2	168
48 x 144	48144VCA	2	2268	5324	5786	6272	6882	7303	3	3	202
48 x 168	48168VCA	2	2756	6063	6597	7159	7443	8092	3	3	236
48 x 192	48192VCA	2	3044	7014	7689	9029	9389	10451	3	3	269
48 x 216	48216VCA	2	3803	7863	8625	10287	10700	11732	3	3	303
60 x 120	60120VCA	2	2357	5696	6176	6683	6898	7470	3	2	210
60 x 144	60144VCA	2	2835	6657	7233	7839	8605	9127	3	3	252
60 x 168	60168VCA	2	3445	7580	8245	8946	9305	10116	3	3	294
60 x 192	60192VCA	2	4135	9095	9894	10734	11165	12139	3	3	336
60 x 216	60216VCA	2	4654	10234	11132	12077	12560	13655	3	3	378

*When specifying Half Drum (BGHDR) or D-Drum (BGDDR) bases where 3 bases are required, the middle base should be specified as a Rectangle base (BGRE).

BASES

MODEL	BASE SHAPES	FINISH	BASE PRICE	LBS	
		<i>Aluminum or Wood Trim</i>			
BGDR-L		BOARDGAME DRUM	Laminate	1422	75
BGDR-V			Veneer	1590	75
BGRE-L		BOARDGAME RECTANGLE	Laminate	939	70
BGRE-V			Veneer	1107	70
BGSQ-L		BOARDGAME SQUARE	Laminate	939	70
BGSQ-V			Veneer	1107	70
BGEL-L		BOARDGAME ELLIPSE	Laminate	1006	65
BGEL-V			Veneer	1177	65
BGDDR-L		BOARDGAME D-DRUM	Laminate	1587	85
BGDDR-V			Veneer	1760	85
BGHDR-L		BOARDGAME HALF DRUM	Laminate	1145	65
BGHDR-V			Veneer	1315	65
PLDR-L		PLINTH BASE DRUM	Laminate	1422	75
PLDR-V			Veneer	1590	75
PLSQ-L		PLINTH BASE SQUARE	Laminate	939	70
PLSQ-V			Veneer	1107	70
PLRE-L		PLINTH BASE RECTANGLE	Laminate	939	70
PLRE-V			Veneer	1107	70

*Bases standard in 22" width. 30" width available, please contact factory for pricing.



For applicable Power & Data modules, please see Table Accessories Price List.

Toll Free: 1-888-761-7732

BOARDGAMES TABLES

TABLETOP SECTIONS AND SEATING LAYOUTS

RECTANGLE		
Size / Shape	Number of Tabletop Sections	Number of Chairs (based on 25" wide chairs)
48 x 96RE	1	8
48 x 120RE	2	10
48 x 144RE	2	10
48 x 168RE	2	12
48 x 192RE	2	14
48 x 216RE	2	14
60 x 120RE	2	10
60 x 144RE	2	12
60 x 168RE	2	12
60 x 192RE	2	14
60 x 216RE	2	16

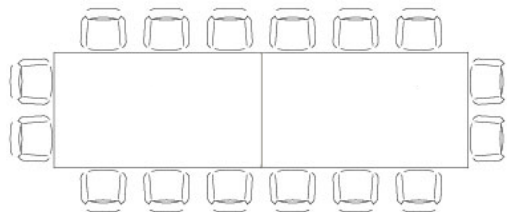

Rectangle 60x216

RACETRACK		
Size / Shape	Number of Tabletop Sections	Number of Chairs (based on 25" wide chairs)
48 x 96RT	1	8
48 x 120RT	2	10
48 x 144RT	2	10
48 x 168RT	2	12
48 x 192RT	2	14
48 x 216RT	2	14
60 x 120RT	2	10
60 x 144RT	2	12
60 x 168RT	2	12
60 x 192RT	2	14
60 x 216RT	2	16

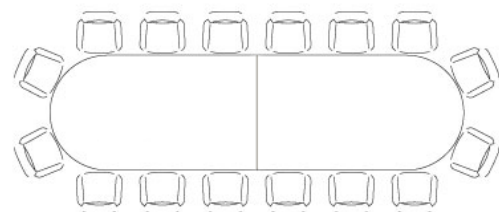

Racetrack 60x216

RECTANGLE ARC ENDS		
Size / Shape	Number of Tabletop Sections	Number of Chairs (based on 25" wide chairs)
48 x 96REA	1	8
48 x 120REA	2	10
48 x 144REA	2	10
48 x 168REA	2	12
48 x 192REA	2	14
48 x 216REA	2	14
60 x 120REA	2	10
60 x 144REA	2	12
60 x 168REA	2	12
60 x 192REA	2	14
60 x 216REA	2	16

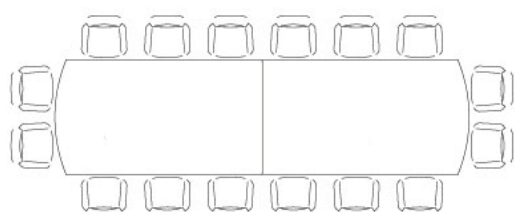

Rectangle Arc Ends 60x216





Pricing March 1, 2019
Discount 57.7% from List prices



SIN 711-11

BOARDGAMES TABLES

TABLETOP SECTIONS AND SEATING LAYOUTS

BOATSHAPE		
Size / Shape	Number of Tabletop Sections	Number of Chairs (based on 25" wide chairs)
48 x 96BT	1	8
48 x 120BT	2	10
48 x 144BT	2	10
48 x 168BT	2	12
48 x 192BT	2	14
48 x 216BT	2	14
60 x 120BT	2	10
60 x 144BT	2	12
60 x 168BT	2	12
60 x 192BT	2	14
60 x 216BT	2	16
Standard with 12" Taper		

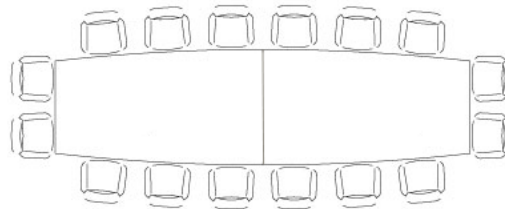

Boatshape 60x216

BOATSHAPE ARC ENDS		
Size / Shape	Number of Tabletop Sections	Number of Chairs (based on 25" wide chairs)
48 x 96BTA	1	8
48 x 120BTA	2	10
48 x 144BTA	2	10
48 x 168BTA	2	12
48 x 192BTA	2	14
48 x 216BTA	2	14
60 x 120BTA	2	10
60 x 144BTA	2	12
60 x 168BTA	2	12
60 x 192BTA	2	14
60 x 216BTA	2	16

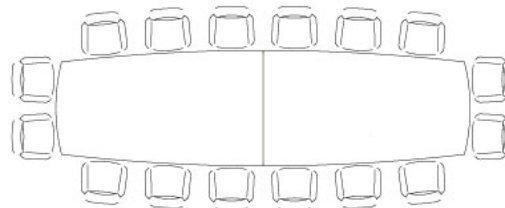

Boatshape Arc Ends 60x216

ELLIPSE		
Size / Shape	Number of Tabletop Sections	Number of Chairs (based on 25" wide chairs)
48 x 96EL	1	6
48 x 120EL	2	6
48 x 144EL	2	8
48 x 168EL	2	10
48 x 192EL	2	10
48 x 216EL	2	12
60 x 120EL	2	8
60 x 144EL	2	10
60 x 168EL	2	10
60 x 192EL	2	12
60 x 216EL	2	14

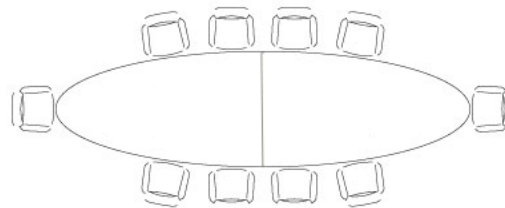



Ellipse 60x216



BOARDGAMES TABLES

TABLETOP SECTIONS AND SEATING LAYOUTS

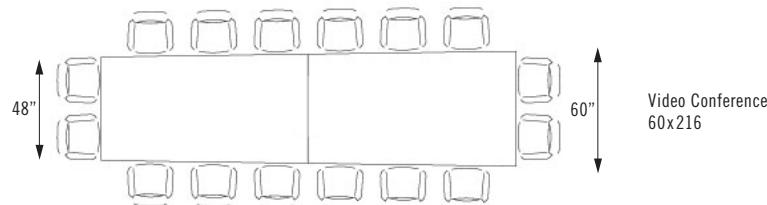
VIDEO CONFERENCE		
Size / Shape	Number of Tabletop Sections	Number of Chairs (based on 25" wide chairs)
48 x 96VC	1	8
48 x 120VC	2	10
48 x 144VC	2	10
48 x 168VC	2	14
48 x 192VC	2	14
48 x 216VC	2	14
60 x 120VC	2	10
60 x 144VC	2	10
60 x 168VC	2	14
60 x 192VC	2	14
60 x 216VC	2	16
<i>Standard with 12" Taper</i>		

VIDEO CONFERENCE ARC		
Size / Shape	Number of Tabletop Sections	Number of Chairs (based on 25" wide chairs)
48 x 96VCA	1	8
48 x 120VCA	2	10
48 x 144VCA	2	10
48 x 168VCA	2	14
48 x 192VCA	2	14
48 x 216VCA	2	14
60 x 120VCA	2	10
60 x 144VCA	2	10
60 x 168VCA	2	14
60 x 192VCA	2	14
60 x 216VCA	2	16
<i>Standard with 12" Taper</i>		

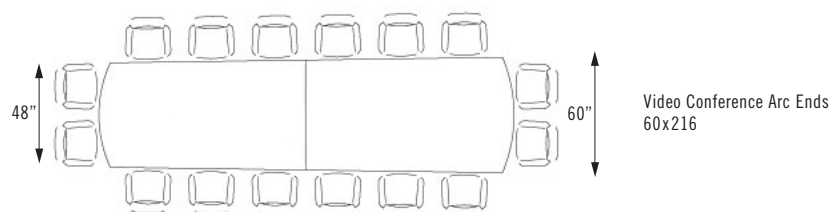

LARGER TABLE SIZES

Boardgames tabletops with a length of 108" to 216" and a width that doesn't exceed 60", will be made in 2 equal pieces. Boardgames tabletops with a length of 216" to 324" and a width that doesn't exceed 60", will be made in 3 equal pieces. All multiple piece tabletops are tight joint fastened. Bases standard in 22" width. 30" width is available, please contact factory for pricing.

WOOD FINISHES AND GRAIN DIRECTION

Finishes

Veneers and hardwood edge finishes are available in our 9 standard stains or stain-to-match which is never an upcharge.

Grain Direction

The grain on a single piece laminate or veneer boardroom tabletop will run lengthwise.

The grain on a 2-piece or more veneer top runs width-wise. The grain on a 2-piece or more laminate top runs length-wise.

BOARDGAMES TABLES POWER AND VOICE/DATA MODULES

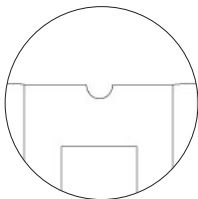
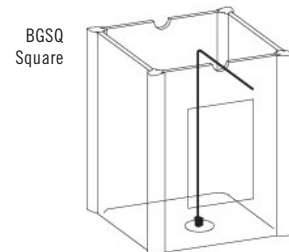
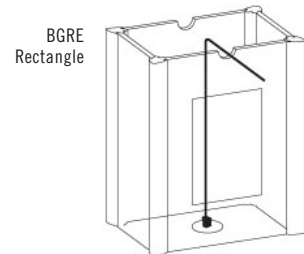
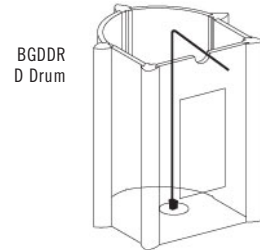
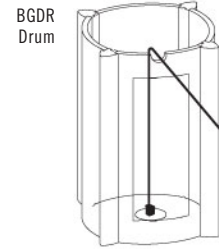
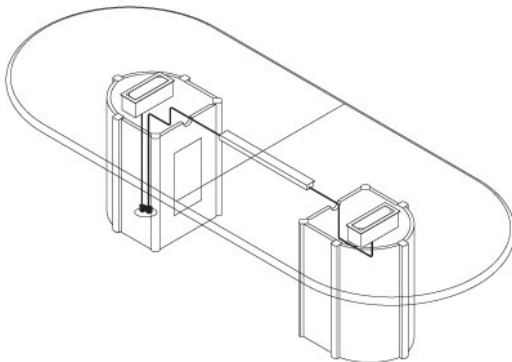
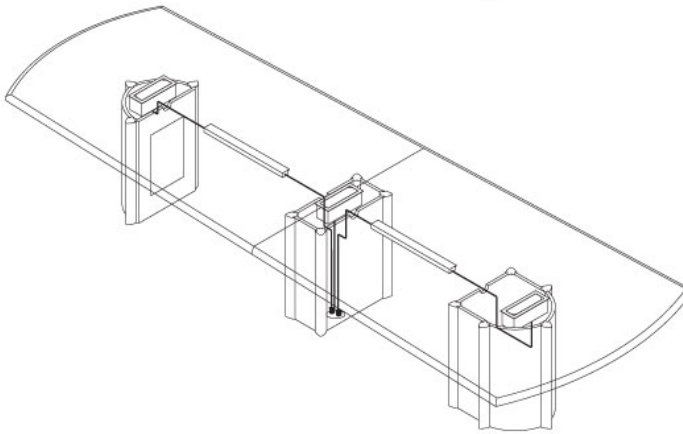
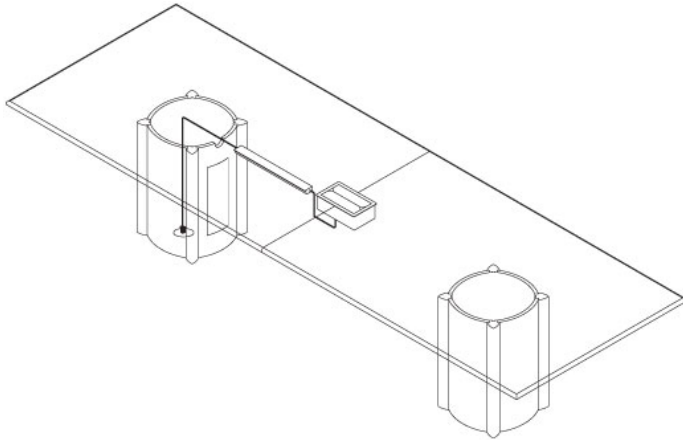

All Boardgames bases are standard with a touch latch removable door and a 3" cutout for wire pass-through at the top



Optional cutout for wire pass-through at the bottom of Boardgames bases must be specified if required

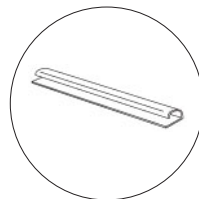

Tops are standard with 24" PVC under table wire manager between bases