

TAILOR Lounge Collection - MODULAR



PRODUCT CODE

91 01 MC - NA

Series	Number of Seats	Type	Arms
91 : Tailor	1 : Single Seat 2 : Two Seat 3 : Three Seat	MC : Mid-Back Connected	NA : No Arm L : Left Arm R : Right Arm

OPTIONS

ARM GAP



ARM CAP



POWER



In table



In seat

FINISHES

FRAME



Select from one of our 76 standard Spectone colors

FABRIC



Select fabrics from one of our textile partners

LAMINATE

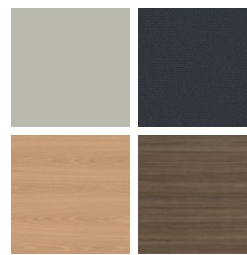

Select from 15 standard laminates or choose any standard Wilsonart, Nevamar, Formica, Arborite and Pionite matte finish laminates at no upcharge

EDGE

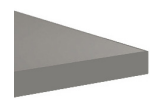

SE

ARM CAPS



Polyurethane

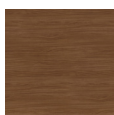

Wood*

*Wood arms are available in 9 standard stains or stain-to-match at no upcharge.



TAILOR Lounge Collection - MODULAR

HOW TO ORDER

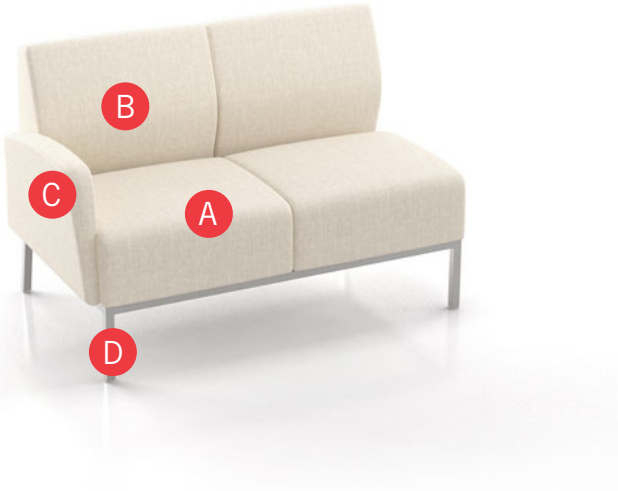

Specify Model

- A** Specify Fabric - Seat¹
Manufacturer, Pattern Name, Color
- B** Specify Fabric - Back¹
Manufacturer, Pattern Name, Color
- C** Specify Fabric - Arms¹
Manufacturer, Pattern Name, Color
- D** Specify Frame Finish

Optional: CAL 133, Moisture Barrier, 1" Gap Between Seat and Arm, Arm Caps, Connecting and Freestanding Tables, Power

Restrictions may apply. See price list tables below for more information.

¹ When multiple fabrics are specified on two and three seat chairs, please provide a drawing and legend for fabric placement.



Model	Fabric - Seat 1	Fabric - Seat 2	Fabric - Back 1	Fabric - Back 2	Fabric - Arm 1	Frame Finish
9102MC-L	Momentum, Beeline, Canvas	Momentum, Beeline, Canvas	Momentum, Beeline, Canvas	Momentum, Beeline, Canvas	Momentum, Beeline, Canvas	Silver

TAILOR Lounge Collection - MODULAR

LAYOUTS

To configure Tailor Modular, please specify left to right facing the configuration.

Tailor has two arm styles - end arms which are tapered, and connecting arms which are straight. Please provide a layout drawing with your purchase order or quote request and Customer Service will determine the appropriate arm (end or connecting) depending on their position within the layout. Arms are shipped assembled on the chair.



Tapered End Arm



Straight Connecting Arm



- A** Choose from one-, two-, three-seat and bariatric modular designs.

Note: Single seat configuration is shown in the example below.

- B** Tapered End Arms are installed at the ends of the layout run.

Note: Exceptions apply, see next page for more information.

- C** When arms are specified between seats or seat-to-table, a Straight Connecting Arm will be used.

- D** To complete your configuration, choose from end of run, spacer or corner connecting tables.

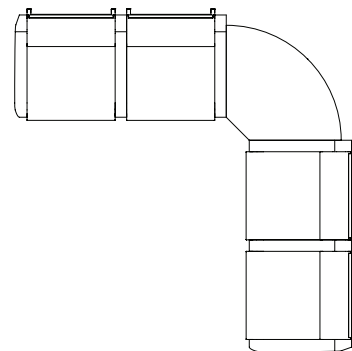
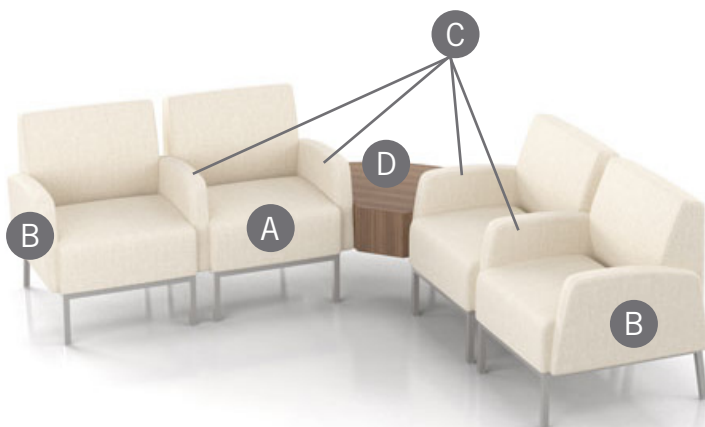

The configuration above can be specified as:

- 9101MC Single Seat, Two Arms (one Tapered End, one Straight Connecting)
- 9101MC-R Single Seat, With Right Arm Only (Straight Connecting)
- 91RC Corner Table - Radius Corner
- 9101MC Single Seat, Two Arms (two Straight Connecting)
- 9101MC-R Single Seat, With Right Arm Only (Tapered End)

TAILOR Lounge Collection - MODULAR

TAPERED END ARMS ON BOTH ENDS

Configurations with **arms on both ends** will have Tapered End Arms as standard.



Configuration above shows Tapered End Arms on outside of chairs, Straight Connecting Arms in center. Regardless of its complexity, when a configuration is ending in arms on both ends, the configuration will be specified with a Tapered End Arm as standard.



- A** Tapered End Arm
- B** Straight Connecting Arm

STRAIGHT CONNECTING ARM ON ONE END

Configurations with an **arm on one end** will have Straight Connecting Arm as standard.



Configuration above is ending in a table on one end, and an arm on the other end of the run. Regardless of its complexity, when a configuration is ending in one arm only, the configuration will be specified with a Straight Connecting Arm as standard. Customers may specify Tapered End Arm at the end of such run, but a special note must be given to Customer Service at the time of quote/order. Note that the arm beside the table will always be a Straight Connecting Arm.

TAILOR Lounge Collection - MODULAR

FOUR SEAT DESIGN, EXAMPLE 1

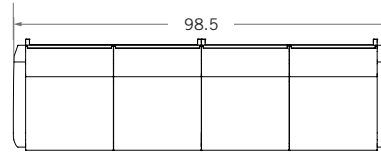
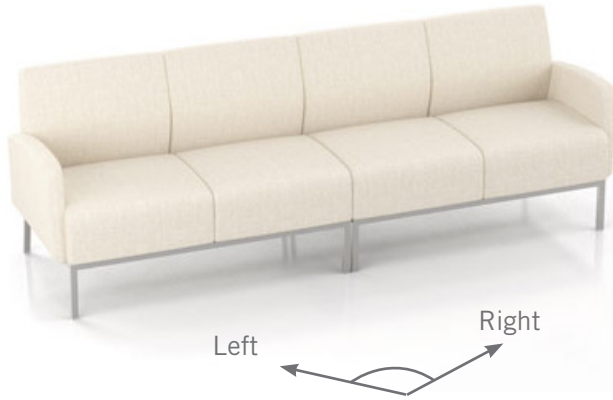

A four-seat configuration may be specified as two two-seat sofas.

- 9102MC-L Two Seat, With Left Arm Only (Tapered End)
- 9102MC-R Two Seat, With Right Arm Only (Tapered End)

FOUR SEAT DESIGN, EXAMPLE 2

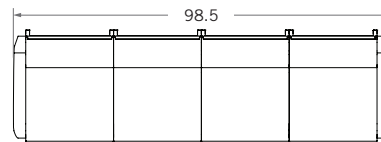

A four-seat configuration may also be specified as four single seat chairs. Please note that the number of legs in this case is double than in the example above.

Note: Specifying with single seats allows for higher flexibility, but this also increases the number of legs.

- 9101MC-L Single Seat, With Left Arm Only (Tapered End)
- 9101MC-NA Single Seat, Without Arms
- 9101MC-NA Single Seat, Without Arms
- 9101MC-R Single Seat, With Right Arm Only (Tapered End)

FOUR SEAT DESIGN, EXAMPLE 3

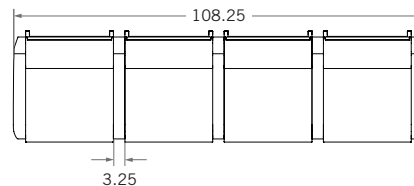

Arms may be added between each seat, increasing the gap between each chair base, as well as the overall width of the configuration.

- 9101MC Single Seat, Two Arms (one Tapered End, one Straight Connecting)
- 9101MC-R Single Seat, With Right Arm Only (Straight Connecting)
- 9101MC-R Single Seat, With Right Arm Only (Straight Connecting)
- 9101MC-R Single Seat, With Right Arm Only (Tapered End)

TAILOR Lounge Collection - MODULAR

END TABLE ON BOTH ENDS, EXAMPLE

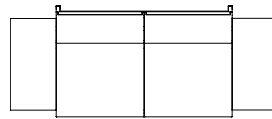
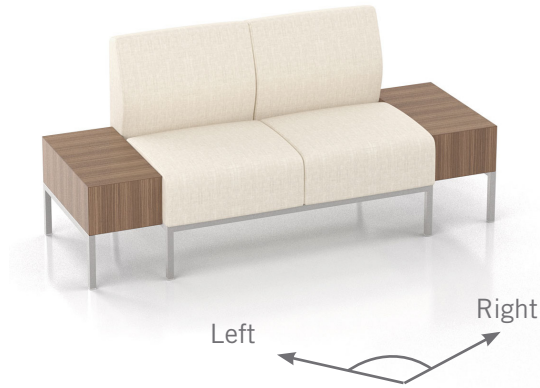

91ERC - 24 x 12
 9102MC-NA
 91ERC - 24 x 12

End of Run Table Closed - Half Size
 Two Seat, Without Arms
 End of Run Table Closed - Half Size

SPACER TABLE BETWEEN SEATS, EXAMPLE

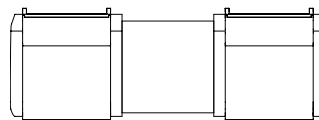
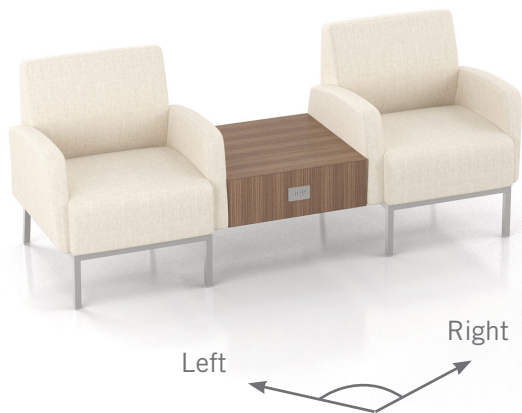

9101MC
 91STC - 24 x 24
 COV-1U-S
 9101MC

Single Seat, Two Arms
 (one Tapered End, one Straight Connecting)
 Spacer Table Closed - Full Size
 Cove, 1 power, 2USB, Silver Pearl
 Single Seat, Two Arms
 (one Straight Connecting, one Tapered End)



TAILOR Lounge Collection - MODULAR

Standard Features

- Separate seat and back
- Wall-saving frame
- Glides
- One connecting plate per unit
- Ships assembled
- Ships 1/carton 24 cu ft

Contact Spec Customer Service to railroad fabrics (specify repeat info and yardage requirement will be provided) and for repeats greater than 5" x 5"

To ensure proper configuration please provide a layout drawing.

Options

- Polyurethane arm caps available in Black (B), Taupe RAL 7006 (T) or Sterling Grey (G), add \$118 List per arm
- For wood arm caps, select from 9 standard stains, or stain-to-match at no upcharge, add \$139 List per arm
- 1" gap between seat and arm available at \$37 List per arm
- Upholstered arms/seat/back can match or contrast
- Cove Mini power module centered in the seat front is available in Black, Silver Pearl and Gloss White. Add \$468 List per seat per module
- Antibacterial and antimicrobial fabrics available
- CAL 133



Tapered End Arm



Straight Connecting Arm



Cove Mini

Single Seat, Without Arms

COM 2.75 yds
 1.25 yds COM per single seat
 1.5 yds COM per single back

MODEL	COM	GR 1	GR 2	GR 3	GR 4	GR 5	GR 6
9101MC-NA	876	1008	1051	1143	1276	1376	1509

Dimensions (inches)
 seat H 18.0 seat W 23.0
 total H 33.0 total W 23.0 depth 29.0

Exceeds BIFMA Seating Durability Test to 500 lbs
 CAL 133, add \$202 List per unit



9101MC-NA
43 lbs

Single Seat, Two Arms

COM 4.25 yds
 1.25 yds COM per single seat
 1.5 yds COM per single back
 0.75 yds COM per arm

MODEL	COM	GR 1	GR 2	GR 3	GR 4	GR 5	GR 6
9101MC	1337	1544	1612	1756	1962	2117	2325

Dimensions (inches)
 seat H 18.0 seat W 23.0 arm H 24.5
 total H 33.0 total W 29.5 depth 29.0

Exceeds BIFMA Seating Durability Test to 500 lbs
 CAL 133, add \$313 List per unit



9101MC
67 lbs



TAILOR Lounge Collection - MODULAR

Standard Features

- Separate seat and back
- Wall-saving frame
- Glides
- One connecting plate per unit
- Ships assembled
- Ships 1/carton 24 cu ft

Contact Spec Customer Service to railroad fabrics (specify repeat info and yardage requirement will be provided) and for repeats greater than 5" x 5"

To ensure proper configuration please provide a layout drawing.

Options

- Polyurethane arm caps available in Black (B), Taupe RAL 7006 (T) or Sterling Grey (G), add \$118 List per arm
- For wood arm caps, select from 9 standard stains, or stain-to-match at no upcharge, add \$139 List per arm
- 1" gap between seat and arm available at \$37 List per arm
- Upholstered arms/seat/back can match or contrast
- Cove Mini power module centered in the seat front is available in Black, Silver Pearl and Gloss White. Add \$468 List per seat per module
- Antibacterial and antimicrobial fabrics available
- CAL 133



Tapered End Arm



Straight Connecting Arm



Cove Mini

Single Seat, With Right Arm Only

COM 3.5 yds
 1.25 yds COM per single seat
 1.5 yds COM per single back
 0.75 yds COM per arm

MODEL	COM	GR 1	GR 2	GR 3	GR 4	GR 5	GR 6
9101MC-R	1107	1276	1331	1450	1619	1747	1917

Dimensions (inches)

seat H	18.0	seat W	23.0	arm H	24.5
total H	33.0	total W	26.25	depth	29.0

Exceeds BIFMA Seating Durability Test to 500 lbs
 CAL 133, add \$259 List per unit



9101MC-R
55 lbs

Single Seat, With Left Arm Only

COM 3.5 yds
 1.25 yds COM per single seat
 1.5 yds COM per single back
 0.75 yds COM per arm

MODEL	COM	GR 1	GR 2	GR 3	GR 4	GR 5	GR 6
9101MC-L	1107	1276	1331	1450	1619	1747	1917

Dimensions (inches)

seat H	18.0	seat W	23.0	arm H	24.5
total H	33.0	total W	26.25	depth	29.0

Exceeds BIFMA Seating Durability Test to 500 lbs
 CAL 133, add \$259 List per unit



9101MC-L
55 lbs



TAILOR Lounge Collection - MODULAR

Standard Features

- Separate seat and back
- Wall-saving frame
- Glides
- One connecting plate per unit
- Ships assembled
- Ships 1/carton 32 cu ft

Contact Spec Customer Service to railroad fabrics (specify repeat info and yardage requirement will be provided) and for repeats greater than 5" x 5"

To ensure proper configuration please provide a layout drawing.

Options

- Polyurethane arm caps available in Black (B), Taupe RAL 7006 (T) or Sterling Grey (G), add \$118 List per arm
- For wood arm caps, select from 9 standard stains, or stain-to-match at no upcharge, add \$139 List per arm
- 1" gap between seat and arm available at \$37 List per arm
- Upholstered arms/seat/back can match or contrast
- Cove Mini power module centered in the seat front is available in Black, Silver Pearl and Gloss White. Add \$468 List per seat per module
- Antibacterial and antimicrobial fabrics available
- CAL 133



Tapered End Arm



Straight Connecting Arm



Cove Mini

Bariatric Single Seat, Two Arms

COM 5 yds
 1.5 yds COM per single seat
 2 yds COM per single back
 0.75 yds COM per arm

MODEL	COM	GR 1	GR 2	GR 3	GR 4	GR 5	GR 6
9101GC	1444	1691	1770	1943	2188	2374	2621

Dimensions (inches)

seat H	18.0	seat W	30.0	arm H	24.5
total H	33.0	total W	36.5	depth	29.0

Exceeds BIFMA Seating Durability Test to 750 lbs
 CAL 133, add \$368 List per unit



9101GC
75 lbs



TAILOR Lounge Collection - MODULAR

Standard Features

- Separate seat and back
- Wall-saving frame
- Glides
- One connecting plate per unit
- Ships assembled
- Ships 1/carton 43 cu ft

Contact Spec Customer Service to railroad fabrics (specify repeat info and yardage requirement will be provided) and for repeats greater than 5" x 5"

To ensure proper configuration please provide a layout drawing.

Options

- Polyurethane arm caps available in Black (B), Taupe RAL 7006 (T) or Sterling Grey (G), add \$118 List per arm
- For wood arm caps, select from 9 standard stains, or stain-to-match at no upcharge, add \$139 List per arm
- 1" gap between seat and arm available at \$37 List per arm
- Upholstered arms/seat/back can match or contrast
- Cove Mini power module centered in the seat front is available in Black, Silver Pearl and Gloss White. Add \$468 List per seat per module
- Antibacterial and antimicrobial fabrics available
- CAL 133



Tapered End Arm



Straight Connecting Arm



Cove Mini

Two Seat, Without Arms

COM 5.5 yds
 1.25 yds COM per single seat
 1.5 yds COM per single back

MODEL	COM	GR 1	GR 2	GR 3	GR 4	GR 5	GR 6
9102MC-NA	1522	1787	1873	2057	2322	2522	2787

Dimensions (inches)

seat H	18.0	seat W	23.0				
total H	33.0	total W	46.0	depth	29.0		

Exceeds BIFMA Seating Durability Test to 570 lbs
 CAL 133, add \$404 List per unit



9102MC-NA
92 lbs

Two Seat, With Two Arms

COM 7 yds
 1.25 yds COM per single seat
 1.5 yds COM per single back
 0.75 yds COM per arm

MODEL	COM	GR 1	GR 2	GR 3	GR 4	GR 5	GR 6
9102MC	1983	2323	2434	2670	3009	3265	3604

Dimensions (inches)

seat H	18.0	seat W	23.0	arm H	24.5		
total H	33.0	total W	52.5	depth	29.0		

Exceeds BIFMA Seating Durability Test to 570 lbs
 CAL 133, add \$518 List per unit



9102MC
116 lbs

TAILOR Lounge Collection - MODULAR

Standard Features

- Separate seat and back
- Wall-saving frame
- Glides
- One connecting plate per unit
- Ships assembled
- Ships 1/carton 43 cu ft

Contact Spec Customer Service to railroad fabrics (specify repeat info and yardage requirement will be provided) and for repeats greater than 5" x 5"

To ensure proper configuration please provide a layout drawing.

Options

- Polyurethane arm caps available in Black (B), Taupe RAL 7006 (T) or Sterling Grey (G), add \$118 List per arm
- For wood arm caps, select from 9 standard stains, or stain-to-match at no upcharge, add \$139 List per arm
- 1" gap between seat and arm available at \$37 List per arm
- Upholstered arms/seat/back can match or contrast
- Cove Mini power module centered in the seat front is available in Black, Silver Pearl and Gloss White. Add \$468 List per seat per module
- Antibacterial and antimicrobial fabrics available
- CAL 133



Tapered End Arm



Straight Connecting Arm



Cove Mini

Two Seat, With Right Arm Only

COM 6.25 yds
 1.25 yds COM per single seat
 1.5 yds COM per single back
 0.75 yds COM per arm

MODEL	COM	GR 1	GR 2	GR 3	GR 4	GR 5	GR 6
9102MC-R	1753	2055	2154	2363	2666	2893	3196

Dimensions (inches)

seat H	18.0	seat W	23.0	arm H	24.5
total H	33.0	total W	49.25	depth	29.0

Exceeds BIFMA Seating Durability Test to 570 lbs
 CAL 133, add \$461 List per unit



9102MC-R
104 lbs

Two Seat, With Left Arm Only

COM 6.25 yds
 1.25 yds COM per single seat
 1.5 yds COM per single back
 0.75 yds COM per arm

MODEL	COM	GR 1	GR 2	GR 3	GR 4	GR 5	GR 6
9102MC-L	1753	2055	2154	2363	2666	2893	3196

Dimensions (inches)

seat H	18.0	seat W	23.0	arm H	24.5
total H	33.0	total W	49.25	depth	29.0

Exceeds BIFMA Seating Durability Test to 570 lbs
 CAL 133, add \$461 List per unit



9102MC-L
104 lbs



TAILOR Lounge Collection - MODULAR

Standard Features

- Separate seat and back
- Wall-saving frame
- Glides
- One connecting plate per unit
- Ships assembled
- Ships 1/carton 62 cu ft

Contact Spec Customer Service to railroad fabrics (specify repeat info and yardage requirement will be provided) and for repeats greater than 5" x 5"

To ensure proper configuration please provide a layout drawing.

Options

- Polyurethane arm caps available in Black (B), Taupe RAL 7006 (T) or Sterling Grey (G), add \$118 List per arm
- For wood arm caps, select from 9 standard stains, or stain-to-match at no upcharge, add \$139 List per arm
- 1" gap between seat and arm available at \$37 List per arm
- Upholstered arms/seat/back can match or contrast
- Cove Mini power module centered in the seat front is available in Black, Silver Pearl and Gloss White. Add \$468 List per seat per module
- Antibacterial and antimicrobial fabrics available
- CAL 133



Tapered End Arm



Straight Connecting Arm



Cove Mini

Three Seat, Without Arms

COM 8.25 yds
 1.25 yds COM per single seat
 1.5 yds COM per single back

MODEL	COM	GR 1	GR 2	GR 3	GR 4	GR 5	GR 6
9103MC-NA	2168	2566	2696	2971	3370	3669	4066

Dimensions (inches)
 seat H 18.0 seat W 23.0
 total H 33.0 total W 69.0 depth 29.0

Exceeds BIFMA Seating Durability Test to 750 lbs
 CAL 133, add \$606 List per unit



9103MC-NA
137 lbs

Three Seat, With Two Arms

COM 9.75 yds
 1.25 yds COM per single seat
 1.5 yds COM per single back
 0.75 yds COM per arm

MODEL	COM	GR 1	GR 2	GR 3	GR 4	GR 5	GR 6
9103MC	2630	3102	3255	3584	4055	4411	4884

Dimensions (inches)
 seat H 18.0 seat W 23.0 arm H 24.5
 total H 33.0 total W 75.5 depth 29.0

Exceeds BIFMA Seating Durability Test to 750 lbs
 CAL 133, add \$720 List per unit



9103MC
161 lbs

TAILOR Lounge Collection - MODULAR

Standard Features

- Separate seat and back
- Wall-saving frame
- Glides
- One connecting plate per unit
- Ships assembled
- Ships 1/carton 62 cu ft

Contact Spec Customer Service to railroad fabrics (specify repeat info and yardage requirement will be provided) and for repeats greater than 5" x 5"

To ensure proper configuration please provide a layout drawing.

Options

- Polyurethane arm caps available in Black (B), Taupe RAL 7006 (T) or Sterling Grey (G), add \$118 List per arm
- For wood arm caps, select from 9 standard stains, or stain-to-match at no upcharge, add \$139 List per arm
- 1" gap between seat and arm available at \$37 List per arm
- Upholstered arms/seat/back can match or contrast
- Cove Mini power module centered in the seat front is available in Black, Silver Pearl and Gloss White. Add \$468 List per seat per module
- Antibacterial and antimicrobial fabrics available
- CAL 133



Tapered End Arm



Straight Connecting Arm



Cove Mini

Three Seat, With Right Arm Only

COM 9 yds
 1.25 yds COM per single seat
 1.5 yds COM per single back
 0.75 yds COM per arm

MODEL	COM	GR 1	GR 2	GR 3	GR 4	GR 5	GR 6
9103MC-R	2399	2834	2975	3277	3712	4039	4474

Dimensions (inches)
 seat H 18.0 seat W 23.0 arm H 24.5
 total H 33.0 total W 72.25 depth 29.0

Exceeds BIFMA Seating Durability Test to 750 lbs
 CAL 133, add \$663 List per unit



9103MC-R
149 lbs

Three Seat, With Left Arm Only

COM 9 yds
 1.25 yds COM per single seat
 1.5 yds COM per single back
 0.75 yds COM per arm

MODEL	COM	GR 1	GR 2	GR 3	GR 4	GR 5	GR 6
9103MC-L	2399	2834	2975	3277	3712	4039	4474

Dimensions (inches)
 seat H 18.0 seat W 23.0 arm H 24.5
 total H 33.0 total W 72.25 depth 29.0

Exceeds BIFMA Seating Durability Test to 750 lbs
 CAL 133, add \$663 List per unit



9103MC-L
149 lbs



TAILOR Lounge Collection - MODULAR TABLES

Standard Features

- Tables in laminate or veneer
- Select laminate tops from 15 standard laminates or choose any standard Wilsonart, Nevamar, Formica, Arborite and Pionite matte finish laminates at no upcharge.
- 9 standard veneers. Stain-to-match available at no upcharge.
- Tables available with Self Edge (SE) only
- Steel table legs available in any Spectone color
- Tops utilize NU Green earth friendly core
- Glides
- One connecting plate per unit
- Ships KD
- 17" height

Options

- To add Cove Mini, clamp mounted with 1 power, 2 USB (charging only), and a 108" long cord to Tailor modular tables, add \$400 List. Cove will be located on the flat front face of the closed tables as standard. It is not recommended to specify power on open tables. Specify separately at time of order.



- Black **COVSMC1P1U-B**
- Silver Pearl **COVSMC1P1U-S**
- Gloss White **COVSMC1P1U-W**

To ensure proper configuration please provide a layout drawing.

Corner and Spacer Connecting Tables

Model		Laminate SE	Veneer SE	Weight	Cu.Ft.
91STC - 24X24	SPACER TABLE CLOSED - FULL SIZE	755	1057	32	11
91STO - 24X24	SPACER TABLE OPEN - FULL SIZE	775	1084	30	11
91STC - 24X12	SPACER TABLE CLOSED - HALF SIZE	706	989	20	7
91STO - 24X12	SPACER TABLE OPEN - HALF SIZE	726	1016	20	7
91ERC - 24X24	END OF RUN TABLE CLOSED - FULL SIZE	911	1275	33	11
91ERO - 24X24	END OF RUN TABLE OPEN - FULL SIZE	930	1302	31	11
91ERC - 24X12	END OF RUN TABLE CLOSED - HALF SIZE	862	1207	21	7
91ERO - 24X12	END OF RUN TABLE OPEN - HALF SIZE	882	1234	21	7
91ERB	END OF RUN TABLE - BULLET	990	1385	36	14
91HM	END OF RUN TABLE - HALF-MOON	1324	2028	75	25
91RC	CORNER TABLE - 90 RADIUS CORNER	990	1385	45	16
91RC45	CORNER TABLE - 45 RADIUS CORNER	990	1385	32	12



91STC - 24 x 24
32 lbs



91STO - 24 x 24
30 lbs



91STC - 24 x 12
20 lbs



91STO - 24 x 12
20 lbs



91RC
45 lbs



91RC45
32 lbs



91ERC - 24 x 24
33 lbs



91ERO - 24 x 24
31 lbs



91ERC - 24 x 12
21 lbs



91ERO - 24 x 12
21 lbs



91ERB
36 lbs



91HM
75 lbs