



TAILOR Lounge Collection - MODULAR



PRODUCT CODE

91 01 MC - NA

Series 91 : Tailor	Number of Seats 1 : Single Seat 2 : Two Seat 3 : Three Seat	Type MC : Mid-Back Connected	Arms NA : No Arm L : Left Arm R : Right Arm
------------------------------	---	--	---



OPTIONS

ARM GAP



ARM CAP



POWER



In table



In seat

FINISHES

FRAME



Select from one of our 76 standard Spectone colors

FABRIC



Select fabrics from one of our textile partners

LAMINATE

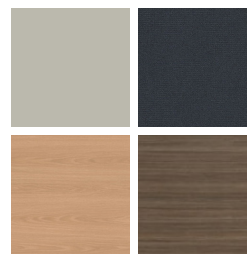

Select from 15 standard laminates or choose any standard Wilsonart, Nevamar, Formica, Arborite and Pionite matte finish laminates at no upcharge

EDGE

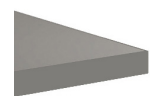

SE

ARM CAPS



Polyurethane

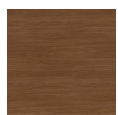

Wood*

*Wood arms are available in 9 standard stains or stain-to-match at no upcharge.



TAILOR Lounge Collection - MODULAR

HOW TO ORDER

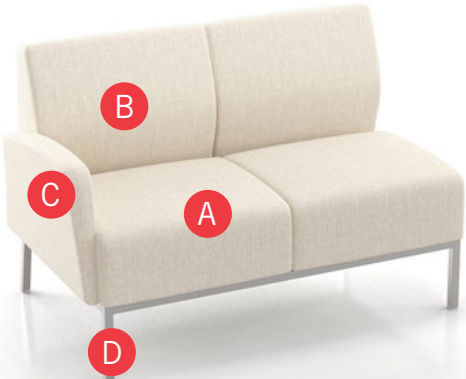

Specify Model

- A** Specify Fabric - Seat¹
Manufacturer, Pattern Name, Color
- B** Specify Fabric - Back¹
Manufacturer, Pattern Name, Color
- C** Specify Fabric - Arms¹
Manufacturer, Pattern Name, Color
- D** Specify Frame Finish

Optional: CAL 133, Moisture Barrier, 1" Gap Between Seat and Arm, Arm Caps, Connecting and Freestanding Tables, Power

Restrictions may apply. See price list tables below for more information.

¹ When multiple fabrics are specified on two and three seat chairs, please provide a drawing and legend for fabric placement.



Model	Fabric - Seat 1	Fabric - Seat 2	Fabric - Back 1	Fabric - Back 2	Fabric - Arm 1	Frame Finish
9102MC-L	Momentum, Beeline, Canvas	Momentum, Beeline, Canvas	Momentum, Beeline, Canvas	Momentum, Beeline, Canvas	Momentum, Beeline, Canvas	Silver

TAILOR Lounge Collection - MODULAR

LAYOUTS

To configure Tailor Modular, please specify left to right facing the configuration.

Tailor has two arm styles - end arms which are tapered, and connecting arms which are straight. Please provide a layout drawing with your purchase order or quote request and Customer Service will determine the appropriate arm (end or connecting) depending on their position within the layout. Arms are shipped assembled on the chair.

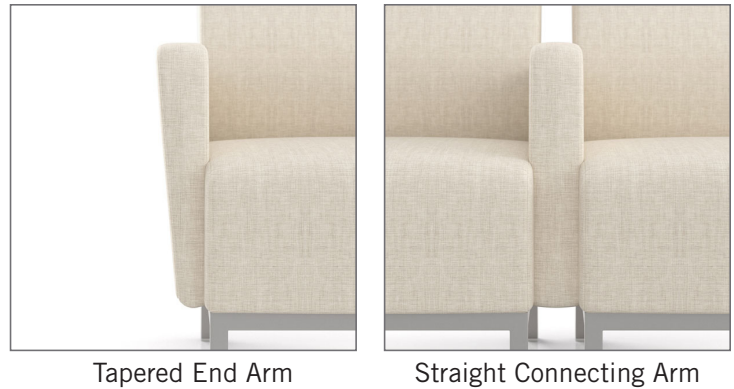

- A** Choose from one-, two-, three-seat and bariatric modular designs.

Note: Single seat configuration is shown in the example below.

- B** Tapered End Arms are installed at the ends of the layout run.

Note: Exceptions apply, see next page for more information.

- C** When arms are specified between seats or seat-to-table, a Straight Connecting Arm will be used.

- D** To complete your configuration, choose from end of run, spacer or corner connecting tables.

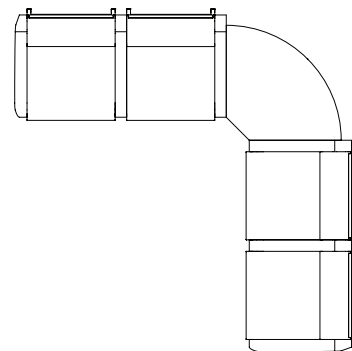
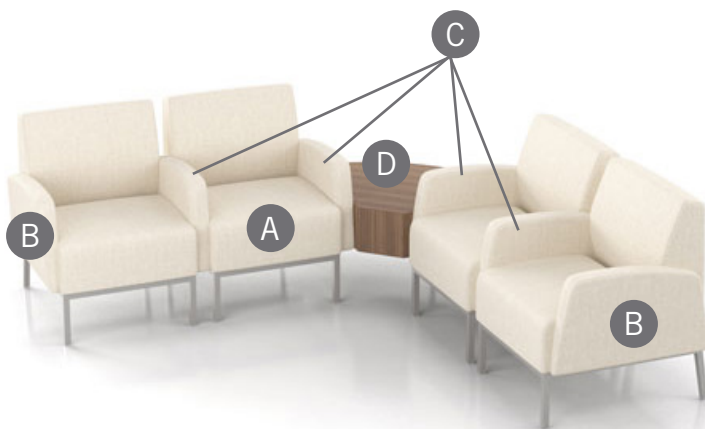

The configuration above can be specified as:

- 9101MC Single Seat, Two Arms (one Tapered End, one Straight Connecting)
- 9101MC-R Single Seat, With Right Arm Only (Straight Connecting)
- 91RC Corner Table - Radius Corner
- 9101MC Single Seat, Two Arms (two Straight Connecting)
- 9101MC-R Single Seat, With Right Arm Only (Tapered End)

TAILOR Lounge Collection - MODULAR

TAPERED END ARMS ON BOTH ENDS

Configurations with **arms on both ends** will have Tapered End Arms as standard.



Configuration above shows Tapered End Arms on outside of chairs, Straight Connecting Arms in center. Regardless of its complexity, when a configuration is ending in arms on both ends, the configuration will be specified with a Tapered End Arm as standard.

- A** Tapered End Arm
- B** Straight Connecting Arm

STRAIGHT CONNECTING ARM ON ONE END

Configurations with an **arm on one end** will have Straight Connecting Arm as standard.



Configuration above is ending in a table on one end, and an arm on the other end of the run. Regardless of its complexity, when a configuration is ending in one arm only, the configuration will be specified with a Straight Connecting Arm as standard. Customers may specify Tapered End Arm at the end of such run, but a special note must be given to Customer Service at the time of quote/order. Note that the arm beside the table will always be a Straight Connecting Arm.

TAILOR Lounge Collection - MODULAR

FOUR SEAT DESIGN, EXAMPLE 1

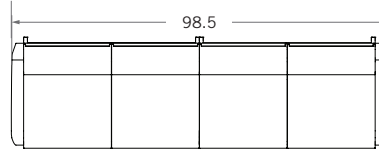
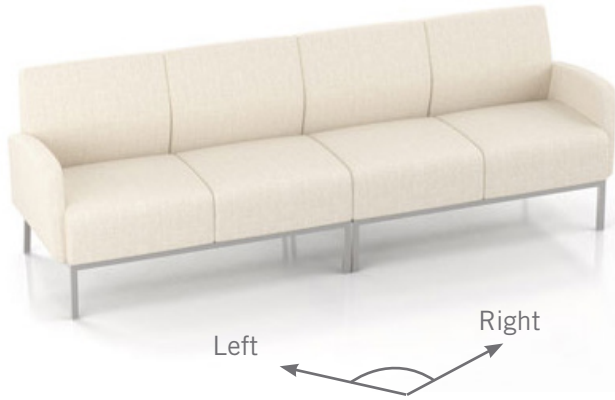

A four-seat configuration may be specified as two two-seat sofas.

- 9102MC-L Two Seat, With Left Arm Only (Tapered End)
- 9102MC-R Two Seat, With Right Arm Only (Tapered End)

FOUR SEAT DESIGN, EXAMPLE 2

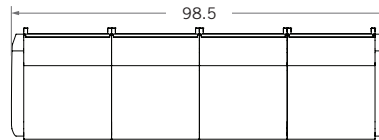

A four-seat configuration may also be specified as four single seat chairs. Please note that the number of legs in this case is double than in the example above.

Note: Specifying with single seats allows for higher flexibility, but this also increases the number of legs.

- 9101MC-L Single Seat, With Left Arm Only (Tapered End)
- 9101MC-NA Single Seat, Without Arms
- 9101MC-NA Single Seat, Without Arms
- 9101MC-R Single Seat, With Right Arm Only (Tapered End)

FOUR SEAT DESIGN, EXAMPLE 3

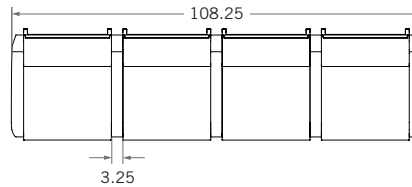

Arms may be added between each seat, increasing the gap between each chair base, as well as the overall width of the configuration.

- 9101MC Single Seat, Two Arms (one Tapered End, one Straight Connecting)
- 9101MC-R Single Seat, With Right Arm Only (Straight Connecting)
- 9101MC-R Single Seat, With Right Arm Only (Straight Connecting)
- 9101MC-R Single Seat, With Right Arm Only (Tapered End)



TAILOR Lounge Collection - MODULAR

END TABLE ON BOTH ENDS, EXAMPLE

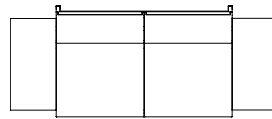
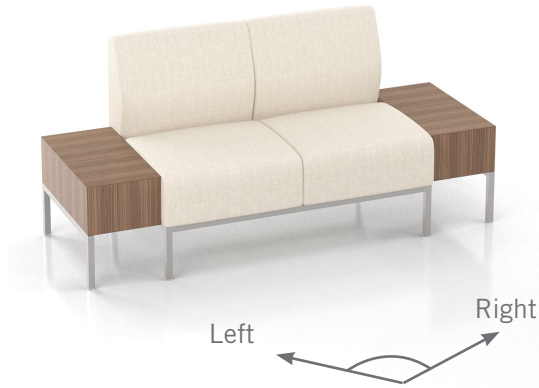

91ERC - 24 x 12
9102MC-NA
91ERC - 24 x 12

End of Run Table Closed - Half Size
Two Seat, Without Arms
End of Run Table Closed - Half Size

SPACER TABLE BETWEEN SEATS, EXAMPLE

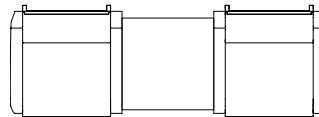
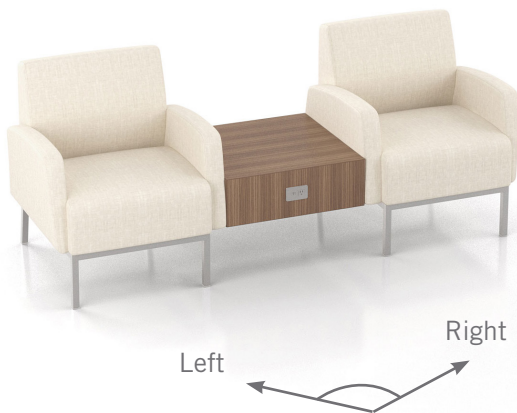

9101MC
91STC - 24 x 24
COV-1U-S
9101MC

Single Seat, Two Arms
(one Tapered End, one Straight Connecting)
Spacer Table Closed - Full Size
Cove, 1 power, 2USB, Silver Pearl
Single Seat, Two Arms
(one Straight Connecting, one Tapered End)



TAILOR Lounge Collection - MODULAR

Standard Features

- Separate seat and back
- Wall-saving frame
- Glides
- One connecting plate per unit
- Ships assembled, 1/carton 24 cu ft

Contact Spec Customer Service to railroad fabrics (specify repeat info and yardage requirement will be provided) and for repeats greater than 5" x 5"

To ensure proper configuration please provide a layout drawing.



Wall-saving Frame

Options

- Polyurethane arm caps available in Black (B), Taupe RAL 7006 (T) or Sterling Grey (G), add \$118 List per arm
- For wood arm caps, select from 9 standard stains, or stain-to-match at no upcharge, add \$139 List per arm
- 1" gap between seat and arm available at \$48 List per arm
- Upholstered arms/seat/back can match or contrast
- Cove Mini power module centered in the seat front is available in Black, Silver Pearl and Gloss White. Add \$426 List per seat per module
- Antibacterial and antimicrobial fabrics available
- CAL 133



Tapered End Arm



Straight Connecting Arm



Cove Mini

Single Seat, Without Arms

COM 2.75 yds
 1.25 yds COM per single seat
 1.5 yds COM per single back

MODEL	COM	GR 1	GR 2	GR 3	GR 4	GR 5	GR 6
9101MC-NA	962	1109	1156	1258	1408	1525	1676

Dimensions (inches)
 seat H 18.0 seat W 23.0
 total H 33.0 total W 23.0 depth 29.0

Exceeds BIFMA Seating Durability Test to 500 lbs
 CAL 133, add \$209 List per unit



9101MC-NA
43 lbs

Single Seat, Two Arms

COM 4.25 yds
 1.25 yds COM per single seat
 1.5 yds COM per single back
 0.75 yds COM per arm

MODEL	COM	GR 1	GR 2	GR 3	GR 4	GR 5	GR 6
9101MC	1468	1698	1773	1931	2166	2346	2583

Dimensions (inches)
 seat H 18.0 seat W 23.0 arm H 24.5
 total H 33.0 total W 29.5 depth 29.0

Exceeds BIFMA Seating Durability Test to 500 lbs
 CAL 133, add \$323 List per unit



9101MC
67 lbs



TAILOR Lounge Collection - MODULAR

Standard Features

- Separate seat and back
- Wall-saving frame
- Glides
- One connecting plate per unit
- Ships assembled, 1/carton 24 cu ft

Contact Spec Customer Service to railroad fabrics (specify repeat info and yardage requirement will be provided) and for repeats greater than 5" x 5"

To ensure proper configuration please provide a layout drawing.



Wall-saving Frame

Options

- Polyurethane arm caps available in Black (B), Taupe RAL 7006 (T) or Sterling Grey (G), add \$118 List per arm
- For wood arm caps, select from 9 standard stains, or stain-to-match at no upcharge, add \$139 List per arm
- 1" gap between seat and arm available at \$48 List per arm
- Upholstered arms/seat/back can match or contrast
- Cove Mini power module centered in the seat front is available in Black, Silver Pearl and Gloss White. Add \$426 List per seat per module
- Antibacterial and antimicrobial fabrics available
- CAL 133



Tapered End Arm



Straight Connecting Arm



Cove Mini

Single Seat, With Right Arm Only

COM 3.5 yds
 1.25 yds COM per single seat
 1.5 yds COM per single back
 0.75 yds COM per arm

MODEL	COM	GR 1	GR 2	GR 3	GR 4	GR 5	GR 6
9101MC-R	1215	1403	1465	1595	1787	1934	2130

Dimensions (inches)
 seat H 18.0 seat W 23.0 arm H 24.5
 total H 33.0 total W 26.25 depth 29.0

Exceeds BIFMA Seating Durability Test to 500 lbs
 CAL 133, add \$266 List per unit



9101MC-R
55 lbs

Single Seat, With Left Arm Only

COM 3.5 yds
 1.25 yds COM per single seat
 1.5 yds COM per single back
 0.75 yds COM per arm

MODEL	COM	GR 1	GR 2	GR 3	GR 4	GR 5	GR 6
9101MC-L	1215	1403	1465	1595	1787	1934	2130

Dimensions (inches)
 seat H 18.0 seat W 23.0 arm H 24.5
 total H 33.0 total W 26.25 depth 29.0

Exceeds BIFMA Seating Durability Test to 500 lbs
 CAL 133, add \$266 List per unit



9101MC-L
55 lbs



TAILOR Lounge Collection - MODULAR

Standard Features

- Separate seat and back
- Wall-saving frame
- Glides
- One connecting plate per unit
- Ships assembled, 1/carton 32 cu ft

Contact Spec Customer Service to railroad fabrics (specify repeat info and yardage requirement will be provided) and for repeats greater than 5" x 5"

To ensure proper configuration please provide a layout drawing.



Wall-saving Frame

Options

- Polyurethane arm caps available in Black (B), Taupe RAL 7006 (T) or Sterling Grey (G), add \$118 List per arm
- For wood arm caps, select from 9 standard stains, or stain-to-match at no upcharge, add \$139 List per arm
- 1" gap between seat and arm available at \$48 List per arm
- Upholstered arms/seat/back can match or contrast
- Cove Mini power module centered in the seat front is available in Black, Silver Pearl and Gloss White. Add \$426 List per seat per module
- Antibacterial and antimicrobial fabrics available
- CAL 133



Tapered End Arm



Straight Connecting Arm



Cove Mini

Bariatric Single Seat, Two Arms

COM 5 yds
 1.5 yds COM per single seat
 2 yds COM per single back
 0.75 yds COM per arm

MODEL	COM	GR 1	GR 2	GR 3	GR 4	GR 5	GR 6
9101GC	1604	1858	1949	2137	2417	2631	2915

Dimensions (inches)

seat H	18.0	seat W	30.0	arm H	24.5
total H	33.0	total W	36.5	depth	29.0

Exceeds BIFMA Seating Durability Test to 750 lbs
 CAL 133, add \$381 List per unit



9101GC
75 lbs



TAILOR Lounge Collection - MODULAR

Standard Features

- Separate seat and back
- Wall-saving frame
- Glides
- One connecting plate per unit
- Ships assembled, 1/carton 43 cu ft

Contact Spec Customer Service to railroad fabrics (specify repeat info and yardage requirement will be provided) and for repeats greater than 5" x 5"

To ensure proper configuration please provide a layout drawing.



Wall-saving Frame

Options

- Polyurethane arm caps available in Black (B), Taupe RAL 7006 (T) or Sterling Grey (G), add \$118 List per arm
- For wood arm caps, select from 9 standard stains, or stain-to-match at no upcharge, add \$139 List per arm
- 1" gap between seat and arm available at \$48 List per arm
- Upholstered arms/seat/back can match or contrast
- Cove Mini power module centered in the seat front is available in Black, Silver Pearl and Gloss White. Add \$426 List per seat per module
- Antibacterial and antimicrobial fabrics available
- CAL 133



Tapered End Arm



Straight Connecting Arm



Cove Mini

Two Seat, Without Arms

COM 5.5 yds
 1.25 yds COM per single seat
 1.5 yds COM per single back

MODEL	COM	GR 1	GR 2	GR 3	GR 4	GR 5	GR 6
9102MC-NA	1671	1966	2062	2265	2566	2796	3101

Dimensions (inches)
 seat H 18.0 seat W 23.0
 total H 33.0 total W 46.0 depth 29.0

Exceeds BIFMA Seating Durability Test to 570 lbs
 CAL 133, add \$418 List per unit



9102MC-NA
92 lbs

Two Seat, With Two Arms

COM 7 yds
 1.25 yds COM per single seat
 1.5 yds COM per single back
 0.75 yds COM per arm

MODEL	COM	GR 1	GR 2	GR 3	GR 4	GR 5	GR 6
9102MC	2178	2555	2678	2938	3323	3617	4008

Dimensions (inches)
 seat H 18.0 seat W 23.0 arm H 24.5
 total H 33.0 total W 52.5 depth 29.0

Exceeds BIFMA Seating Durability Test to 570 lbs
 CAL 133, add \$532 List per unit



9102MC
116 lbs



TAILOR Lounge Collection - MODULAR

Standard Features

- Separate seat and back
- Wall-saving frame
- Glides
- One connecting plate per unit
- Ships assembled, 1/carton 43 cu ft

Contact Spec Customer Service to railroad fabrics (specify repeat info and yardage requirement will be provided) and for repeats greater than 5" x 5"

To ensure proper configuration please provide a layout drawing.



Wall-saving Frame

Options

- Polyurethane arm caps available in Black (B), Taupe RAL 7006 (T) or Sterling Grey (G), add \$118 List per arm
- For wood arm caps, select from 9 standard stains, or stain-to-match at no upcharge, add \$139 List per arm
- 1" gap between seat and arm available at \$48 List per arm
- Upholstered arms/seat/back can match or contrast
- Cove Mini power module centered in the seat front is available in Black, Silver Pearl and Gloss White. Add \$426 List per seat per module
- Antibacterial and antimicrobial fabrics available
- CAL 133



Tapered End Arm



Straight Connecting Arm



Cove Mini

Two Seat, With Right Arm Only

COM 6.25 yds
 1.25 yds COM per single seat
 1.5 yds COM per single back
 0.75 yds COM per arm

MODEL	COM	GR 1	GR 2	GR 3	GR 4	GR 5	GR 6
9102MC-R	1925	2260	2370	2602	2943	3207	3555

Dimensions (inches)
 seat H 18.0 seat W 23.0 arm H 24.5
 total H 33.0 total W 49.25 depth 29.0

Exceeds BIFMA Seating Durability Test to 570 lbs
 CAL 133, add \$475 List per unit



9102MC-R
104 lbs

Two Seat, With Left Arm Only

COM 6.25 yds
 1.25 yds COM per single seat
 1.5 yds COM per single back
 0.75 yds COM per arm

MODEL	COM	GR 1	GR 2	GR 3	GR 4	GR 5	GR 6
9102MC-L	1925	2260	2370	2602	2943	3207	3555

Dimensions (inches)
 seat H 18.0 seat W 23.0 arm H 24.5
 total H 33.0 total W 49.25 depth 29.0

Exceeds BIFMA Seating Durability Test to 570 lbs
 CAL 133, add \$475 List per unit



9102MC-L
104 lbs

TAILOR Lounge Collection - MODULAR

Standard Features

- Separate seat and back
- Wall-saving frame
- Glides
- One connecting plate per unit
- Ships assembled, 1/carton 62 cu ft

Contact Spec Customer Service to railroad fabrics (specify repeat info and yardage requirement will be provided) and for repeats greater than 5" x 5"

To ensure proper configuration please provide a layout drawing.



Wall-saving Frame

Options

- Polyurethane arm caps available in Black (B), Taupe RAL 7006 (T) or Sterling Grey (G), add \$118 List per arm
- For wood arm caps, select from 9 standard stains, or stain-to-match at no upcharge, add \$139 List per arm
- 1" gap between seat and arm available at \$48 List per arm
- Upholstered arms/seat/back can match or contrast
- Cove Mini power module centered in the seat front is available in Black, Silver Pearl and Gloss White. Add \$426 List per seat per module
- Antibacterial and antimicrobial fabrics available
- CAL 133



Tapered End Arm



Straight Connecting Arm



Cove Mini

Three Seat, Without Arms

COM 8.25 yds
 1.25 yds COM per single seat
 1.5 yds COM per single back

MODEL	COM	GR 1	GR 2	GR 3	GR 4	GR 5	GR 6
9103MC-NA	2382	2823	2967	3273	3722	4068	4526

Dimensions (inches)
 seat H 18.0 seat W 23.0
 total H 33.0 total W 69.0 depth 29.0

Exceeds BIFMA Seating Durability Test to 750 lbs
 CAL 133, add \$627 List per unit



9103MC-NA
137 lbs

Three Seat, With Two Arms

COM 9.75 yds
 1.25 yds COM per single seat
 1.5 yds COM per single back
 0.75 yds COM per arm

MODEL	COM	GR 1	GR 2	GR 3	GR 4	GR 5	GR 6
9103MC	2888	3412	3583	3945	4479	4890	5433

Dimensions (inches)
 seat H 18.0 seat W 23.0 arm H 24.5
 total H 33.0 total W 75.5 depth 29.0

Exceeds BIFMA Seating Durability Test to 750 lbs
 CAL 133, add \$741 List per unit



9103MC
161 lbs



TAILOR Lounge Collection - MODULAR

Standard Features

- Separate seat and back
- Wall-saving frame
- Glides
- One connecting plate per unit
- Ships assembled, 1/carton 62 cu ft

Contact Spec Customer Service to railroad fabrics (specify repeat info and yardage requirement will be provided) and for repeats greater than 5" x 5"

To ensure proper configuration please provide a layout drawing.



Wall-saving Frame

Options

- Polyurethane arm caps available in Black (B), Taupe RAL 7006 (T) or Sterling Grey (G), add \$118 List per arm
- For wood arm caps, select from 9 standard stains, or stain-to-match at no upcharge, add \$139 List per arm
- 1" gap between seat and arm available at \$48 List per arm
- Upholstered arms/seat/back can match or contrast
- Cove Mini power module centered in the seat front is available in Black, Silver Pearl and Gloss White. Add \$426 List per seat per module
- Antibacterial and antimicrobial fabrics available
- CAL 133



Tapered End Arm



Straight Connecting Arm



Cove Mini

Three Seat, With Right Arm Only

COM 9 yds
 1.25 yds COM per single seat
 1.5 yds COM per single back
 0.75 yds COM per arm

MODEL	COM	GR 1	GR 2	GR 3	GR 4	GR 5	GR 6
9103MC-R	2634	3117	3276	3609	4101	4478	4978

Dimensions (inches)
 seat H 18.0 seat W 23.0 arm H 24.5
 total H 33.0 total W 72.25 depth 29.0

Exceeds BIFMA Seating Durability Test to 750 lbs
 CAL 133, add \$684 List per unit



9103MC-R
149 lbs

Three Seat, With Left Arm Only

COM 9 yds
 1.25 yds COM per single seat
 1.5 yds COM per single back
 0.75 yds COM per arm

MODEL	COM	GR 1	GR 2	GR 3	GR 4	GR 5	GR 6
9103MC-L	2634	3117	3276	3609	4101	4478	4978

Dimensions (inches)
 seat H 18.0 seat W 23.0 arm H 24.5
 total H 33.0 total W 72.25 depth 29.0

Exceeds BIFMA Seating Durability Test to 750 lbs
 CAL 133, add \$684 List per unit



9103MC-L
149 lbs



TAILOR Lounge Collection - MODULAR TABLES

Standard Features

- Tables in laminate or veneer
- Select laminate tops from 15 standard laminates or choose any standard Wilsonart, Nevamar, Formica, Arborite and Pionite matte finish laminates at no upcharge.
- 9 standard veneers. Stain-to-match available at no upcharge.
- Tables available with Self Edge (SE) only
- Steel table legs available in any Spectone color
- Tops utilize NU Green earth friendly core
- Glides
- One connecting plate per unit
- Ships KD
- 17" height

Options

- To add Cove Mini, clamp mounted with 1 power, 2 USB (charging only), and a 108" long cord to Tailor modular tables, add \$344 List. Cove will be located on the flat front face of the closed tables as standard. It is not recommended to specify power on open tables. Specify separately at time of order.



- Black **COVSMC1P1U-B**
- Silver Pearl **COVSMC1P1U-S**
- Gloss White **COVSMC1P1U-W**

To ensure proper configuration please provide a layout drawing.

Corner and Spacer Connecting Tables

Model		Laminate SE	Veneer SE	Weight	Cu.Ft.
91STC - 24X24	SPACER TABLE CLOSED - FULL SIZE	830	1163	32	11
91STO - 24X24	SPACER TABLE OPEN - FULL SIZE	852	1192	30	11
91STC - 24X12	SPACER TABLE CLOSED - HALF SIZE	777	1087	20	7
91STO - 24X12	SPACER TABLE OPEN - HALF SIZE	798	1117	20	7
91ERC - 24X24	END OF RUN TABLE CLOSED - FULL SIZE	1002	1402	33	11
91ERO - 24X24	END OF RUN TABLE OPEN - FULL SIZE	1023	1432	31	11
91ERC - 24X12	END OF RUN TABLE CLOSED - HALF SIZE	948	1327	21	7
91ERO - 24X12	END OF RUN TABLE OPEN - HALF SIZE	969	1357	21	7
91ERB	END OF RUN TABLE - BULLET	1090	1526	36	14
91HM	END OF RUN TABLE - HALF-MOON	1456	2231	75	25
91RC	CORNER TABLE - 90 RADIUS CORNER	1090	1526	45	16
91RC45	CORNER TABLE - 45 RADIUS CORNER	1090	1526	32	12

